

CATÁLOGO
LINHA PESADA
2023
REVISÃO - 1

• RETENTORES • JUNTAS • PARAFUSOS

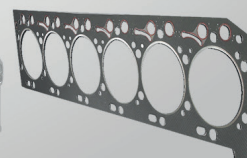

// CUMMINS

// MERCEDES

// MWM

// VOLKSWAGEN

// MAXION PERKINS

// IVECO

// LINHA PESADA

// SCANIA

// JOHN DEERE

// FORD

// VALTRA

// CUMMINS

// MWM

DESCRIÇÃO	PÁGINA
TORQUE	4
TORQUE	5
ÍNDICE	6
ÍNDICE - CUMMINS	7
ÍNDICE - MERCEDES	8
ÍNDICE - MERCEDES - MWM	9
ÍNDICE - MAXION PERKINS	10
ÍNDICE - IVECO - SCANIA - JOHN DEERE	11
ÍNDICE - FORD	12
ÍNDICE - VALTRA - VOLKSWAGEN	13
LEGENDAS E ESPECIFICAÇÕES	14





TORQUE

LINHA	Nº ABR	APLICAÇÃO-JUNTA DE CABEÇOTE	JUNTA	SEQUENCIA DE APERTO	TORQUE DE MONTAGEM	Ø CILINDRO
VOLKSWAGEN	58512701	KOMBI DIESEL 1.6			1 FASE 2 KGFM 2 FASE 4 KGFM 3 FASE 6 KGFM 4 FASE 180° 5 FASE 90°	Ø 76,5 MM
MERCEDES BENZ	56131803	MERCEDES OM - 314			1 FASE 6 KGFM 2 FASE 9 KGFM 3 FASE 12 A 13 KGFM	Ø 97,0 MM
MERCEDES BENZ	56108701	MERCEDES OM -364			1 FASE 6 KGFM 2 FASE 9 KGFM 3 FASE 12 A 13 KGFM 4 FASE PARAFUSO DODCAGONAL 90°	Ø 97,5 MM
MERCEDES BENZ	56137200	MERCEDES OM - 447 / 449			1 FASE 1 KGFM 2 FASE 5 KGFM 3 FASE 10 KGFM 4 FASE 14 KGFM 5 FASE 18 A 19 KGFM 6 FASE 90° A 100°	Ø 128,0 MM
MERCEDES BENZ	56169405	MERCEDES OM 457 ELETRÔNICO			1 FASE 2 KGFM 2 FASE 6 KGFM 3 FASE 12 KGFM 4 FASE 18 KGFM 5 FASE 90° A 100° 6 FASE 90° A 100°	Ø 128,0 MM
MERCEDES BENZ	56149603	MERCEDES OM 352 / 352A			1 FASE 6 KGFM 2 FASE 9 KGFM 3 FASE 12 A 13 KGFM	Ø 97,5 MM
MERCEDES BENZ	56150201	MERCEDES OM 352A / OM 366 / OM 366A / OM 366 LA			1 FASE 6 KGFM 2 FASE 9 KGFM 3 FASE 12 A 13 KGFM 4 FASE PARAFUSO DODECAGONAL 90°	Ø 97,5 MM
MERCEDES BENZ	56173905 56173105	MERCEDES OM 904 ELETRÔNICO MERCEDES OM 924 ELETRÔNICO			1 FASE 2 KGFM 2 FASE 7 KGFM 3 FASE 17 KGFM 4 FASE 28 KGFM 5 FASE 90° A 100° 6 FASE 90° A 100°	Ø 904-102,0MM Ø 924-106,0MM
MERCEDES BENZ	56173005 56173205	MERCEDES OM 906 ELETRÔNICO MERCEDES OM 926 ELETRÔNICO			1 FASE 2 KGFM 2 FASE 7 KGFM 3 FASE 17 KGFM 4 FASE 28 KGFM 5 FASE 90° A 100° 6 FASE 90° A 100°	Ø 904-102,0MM Ø 924-106,0MM
MERCEDES BENZ	56111903	MERCEDES OM 355			1 FASE 4 KGFM 2 FASE 8 KGFM 3 FASE 12 KGFM	Ø 128,0 MM
CUMMINS	58312601	CUMMINS MOTOR 4BT 4.9 4CI-LINDROS			1 FASE 8 KGFM (TODOS) 2 FASE 90°*9KGFM (TODOS) 3 FASE 12 KGFM (PARAFUSOS LONGOS) 4 FASE 90° (TODOS)	Ø 102,0 MM
PERKINS	58312601	CUMMINS MOTOR 6BT 5.9 6CI-LINDROS			1 FASE 8 KGFM (TODOS) 2 FASE 90°*9KGFM (TODOS) 3 FASE 12 KGFM (PARAFUSOS LONGOS) 4 FASE 90° (TODOS)	Ø 102,0 MM
PERKINS	56310501	CUMMINS MOTOR 6CT 8.3 6CI-LINDROS			1 FASE 7 KGFM 2 FASE 15 KGFM 3 FASE 22 KGFM	Ø 114,0 MM

TORQUE - LINHA PESADA

LINHA	Nº ABR	APLICAÇÃO-JUNTA DE CABEÇOTE	JUNTA	SEQUENCIA DE APERTO	TORQUE DE MONTAGEM	Ø CILINDRO
MWM	50965300	MAXION HSD 2.5			1 FASE 4 KGFM 2 FASE 4 KGFM 3 FASE 90° + 4 KGFM 4 FASE 60° 5 FASE 60° 6 FASE 20° PARAFUSO M20X140	Ø 114,0 MM
MWM	50971600	MAXION 6354.4 - Q208 6354,4			1 FASE 4 KGFM 2 FASE 8 KGFM 3 FASE 13,5 KGFM 4 FASE 90° + 13,5 KGFM APÓS 1000KM REPETIR 4° FASE	MBB Ø 90,5 MM GM/FORD Ø 90,75 MM
MWM	50965504	PERKINS 4236/4248 Q20B 4236			1 FASE 4 KGFM 2 FASE 8 KGFM 3 FASE 13 A 13,8 KGFM	Ø 98,48 MM
MWM	50953304	MAXION S4/S4T/S4T PLUS/P 4000			1 FASE 3 KGFM 2 FASE 120° 3 FASE 180°	Ø 98,48 MM
MWM	50911701 50911601	PERKINS 4203(INJEÇÃO DIRETA) PERKINS 4203(INJEÇÃO INDIRETA)			1 FASE 2 KGFM 2 FASE 4 KGFM 3 FASE 7 KGFM 4 FASE 9 A 9,7 KGFM	Ø 100,0 MM
MWM	54395700	MWM SPRINT 4.07 4			1 FASE 3 KGFM 2 FASE 6 KGFM 3 FASE 10 KGFM 4 FASE 90° 5 FASE 90°	Ø 91,48 MM
MWM	54395800	MWM SPRINT 6.07			1 FASE 7 KGFM 2 FASE 15 KGFM 3 FASE 22 KGFM 1 FASE 7 KGFM 2 FASE 15 KGFM	Ø 93,0 MM
MWM	54319000	MWM D-229/TD 229			1 FASE PARAFUSO 22MM 10 KGFM 2 FASE PARAFUSO 22MM 15 KGFM 3 FASE PARAFUSO 22MM 21 KGFM 1 FASE PARAFUSO 17MM 6 A 7 KGFM 2 FASE PARAFUSO 17MM 57° A 63° 3 FASE PARAFUSO 17MM 57° A 63°	Ø 93,0 MM
MWM	54364904	MWM 4.10/6.10 9(X-10)			1 FASE 6 A 7 KGFM 2 FASE 60° 3 FASE 60°	Ø 103,0 MM
MWM	543119202	MWM 4.12/6.12 (ACTEON)			1 FASE 6 A 7 KGFM 2 FASE 60° 3 FASE 60°	Ø 105,0 MM

A decorative icon consisting of two parallel blue diagonal lines, slanted upwards from left to right.

ÍNDICE

Nº ABR	MOTOR	DESCRIÇÃO		PÁGINA
68313943	4B/4BT	JOGO DE JUNTAS COMPLETO	SEM RETENORES	18
78313943	4B/4BT	JOGO DE JUNTAS COMPLETO	COM RETENORES	18
68333941	4B/4BT	JOGO DE JUNTAS SUPERIOR	SEM RETENORES	18
78333941	4B/4BT	JOGO DE JUNTAS SUPERIOR	COM RETENORES	18
68333940	4B/4BT	JOGO DE JUNTAS INFERIOR	SEM RETENORES	18
78333940	4B/4BT	JOGO DE JUNTAS INFERIOR	COM RETENORES	18
78310643	ISBe4 3.9L	JOGO DE JUNTAS COMPLETO	COM RETENORES	20
78330641	ISBe4 3.9L	JOGO DE JUNTAS SUPERIOR	COM RETENORES	20
78330640	ISBe4 3.9L	JOGO DE JUNTAS INFERIOR	COM RETENORES	20
68315943	6B/6BT	JOGO DE JUNTAS COMPLETO	SEM RETENORES	22
78315943	6B/6BT	JOGO DE JUNTAS COMPLETO	COM RETENORES	22
68335941	6B/6BT	JOGO DE JUNTAS SUPERIOR	SEM RETENORES	22
78335941	6B/6BT	JOGO DE JUNTAS SUPERIOR	COM RETENORES	22
68335940	6B/6BT	JOGO DE JUNTAS INFERIOR	SEM RETENORES	22
78335940	6B/6BT	JOGO DE JUNTAS INFERIOR	COM RETENORES	24
68310663	ISBe6 5.9L	JOGO DE JUNTAS COMPLETO	SEM RETENORES	24
78310663	ISBe6 5.9L	JOGO DE JUNTAS COMPLETO	COM RETENORES	24
68330661	ISBe6 5.9L	JOGO DE JUNTAS SUPERIOR	SEM RETENORES	24
78330661	ISBe6 5.9L	JOGO DE JUNTAS SUPERIOR	COM RETENORES	24
68330660	ISBe6 5.9L	JOGO DE JUNTAS INFERIOR	SEM RETENORES	24
78330660	ISBe6 5.9L	JOGO DE JUNTAS INFERIOR	COM RETENORES	24
68314943	6C/6CTA	JOGO DE JUNTAS COMPLETO	SEM RETENORES	26
78314943	6C/6CTA	JOGO DE JUNTAS COMPLETO	COM RETENORES	26
68334941	6C/6CTA	JOGO DE JUNTAS SUPERIOR	SEM RETENORES	26
78334941	6C/6CTA	JOGO DE JUNTAS SUPERIOR	COM RETENORES	26
68334940	6C/6CTA	JOGO DE JUNTAS INFERIOR	SEM RETENORES	26
78334940	6C/6CTA	JOGO DE JUNTAS INFERIOR	COM RETENORES	26
78314949	6C/6CTA	JOGO DE JUNTAS COMPLETO	COM RETENORES COM ANÉIS DE CAMISA	26
78334949	6C/6CTA	JOGO DE JUNTAS INFERIOR	COM RETENORES COM ANÉIS DE CAMISA	26
68310593	ISC 8.3L/ ISL 8.9L	JOGO DE JUNTAS COMPLETO	SEM RETENORES	30
78310593	ISC 8.3L/ ISL 8.9L	JOGO DE JUNTAS COMPLETO	COM RETENORES	30
68330591	ISC 8.3L/ ISL 8.9L	JOGO DE JUNTAS SUPERIOR	SEM RETENORES	30
78330591	ISC 8.3L/ ISL 8.9L	JOGO DE JUNTAS SUPERIOR	COM RETENORES	30
68330590	ISC 8.3L/ ISL 8.9L	JOGO DE JUNTAS INFERIOR	SEM RETENORES	30
78330590	ISC 8.3L/ ISL 8.9L	JOGO DE JUNTAS INFERIOR	COM RETENORES	30
68310772	ISB4.5 / QSB4.5	JOGO DE JUNTAS COMPLETO	SEM RETENORES	32
78310772	ISB4.5 / QSB4.5	JOGO DE JUNTAS COMPLETO	COM RETENORES	32
68330771	ISB4.5 / QSB4.5	JOGO DE JUNTAS SUPERIOR	SEM RETENORES	32
78330771	ISB4.5 / QSB4.5	JOGO DE JUNTAS SUPERIOR	COM RETENORES	32
68330770	ISB4.5 / QSB4.5	JOGO DE JUNTAS INFERIOR	SEM RETENORES	32
78330770	ISB4.5 / QSB4.5	JOGO DE JUNTAS INFERIOR	COM RETENORES	32
68310752	ISB6.7/QSB6.7	JOGO DE JUNTAS COMPLETO	SEM RETENORES	32
78310752	ISB6.7/QSB6.7	JOGO DE JUNTAS COMPLETO	COM RETENORES	34
68330751	ISB6.7/QSB6.7	JOGO DE JUNTAS SUPERIOR	SEM RETENORES	34
78330751	ISB6.7/QSB6.7	JOGO DE JUNTAS SUPERIOR	COM RETENORES	34
68330750	ISB6.7/QSB6.7	JOGO DE JUNTAS INFERIOR	SEM RETENORES	34
78330750	ISB6.7/QSB6.7	JOGO DE JUNTAS INFERIOR	COM RETENORES	34
78310732	ISF 4 CILINDROS.3.8L	JOGO DE JUNTAS COMPLETO	COM RETENORES	36
78330732	ISF 4 CILINDROS.3.8L	JOGO DE JUNTAS SUPERIOR	COM RETENORES	36
78330730	ISF 4 CILINDROS.3.8L	JOGO DE JUNTAS INFERIOR	COM RETENORES	36
78310712	ISF 4 CILINDROS.2.8L	JOGO DE JUNTAS COMPLETO	COM RETENORES	38
78330712	ISF 4 CILINDROS.2.8L	JOGO DE JUNTAS SUPERIOR	COM RETENORES	38
78330710	ISF 4 CILINDROS.2.8L	JOGO DE JUNTAS INFERIOR	COM RETENORES	38

MERCEDES

Nº ABR	MOTOR	DESCRIÇÃO	PÁGINA	
66116081	OM314	JOGO DE JUNTAS COMPLETO	SEM RETENTORES E COM JUNTA DE CABEÇOTE 98,5 MM	44
76116081	OM314	JOGO DE JUNTAS COMPLETO	COM RETENTORES E COM JUNTA DE CABEÇOTE 98,5 MM	44
76126081	OM314	JOGO DE JUNTAS COMPLETO	COM RETENTORES E COM JUNTA DE CABEÇOTE 100,0 MM	44
76136081	OM314	JOGO DE JUNTAS SUPERIOR	COM RETENTORES E COM JUNTA DE CABEÇOTE 98,5 MM	44
76121681	OM364	JOGO DE JUNTAS COMPLETO	COM RETENTORES E COM JUNTA DE CABEÇOTE 98,5 MM	46
76111681	OM364	JOGO DE JUNTAS COMPLETO	COM RETENTORES E COM JUNTA DE CABEÇOTE 100,0 MM	46
76121671	OM364A	JOGO DE JUNTAS COMPLETO	COM RETENTORES E COM JUNTA DE CABEÇOTE 98,5 MM	46
76111671	OM364A	JOGO DE JUNTAS COMPLETO	COM RETENTORES E COM JUNTA DE CABEÇOTE 100,0 MM	46
76131671	OM364/364A	JOGO DE JUNTAS SUPERIOR	COM RETENTORES E COM JUNTA DE CABEÇOTE 98,5 MM	46
76131681	OM364/364A	JOGO DE JUNTAS SUPERIOR	COM RETENTORES E COM JUNTA DE CABEÇOTE 100,0 MM	46
76141721	OM352	JOGO DE JUNTAS COMPLETO	COM RETENTORES E COM JUNTA DE CABEÇOTE 98,5 MM	50
76121721	OM352	JOGO DE JUNTAS COMPLETO	COM RETENTORES E COM JUNTA DE CABEÇOTE 100,0 MM	50
76141031	OM352A/LA	JOGO DE JUNTAS COMPLETO	COM RETENTORES E COM JUNTA DE CABEÇOTE 98,5 MM	50
76121031	OM352A/LA	JOGO DE JUNTAS COMPLETO	COM RETENTORES E COM JUNTA DE CABEÇOTE 100,0 MM	50
76131721	OM352A/LA	JOGO DE JUNTAS SUPERIOR	COM RETENTORES E COM JUNTA DE CABEÇOTE 98,5 MM	50
76131031	OM352A/LA	JOGO DE JUNTAS SUPERIOR	COM RETENTORES E COM JUNTA DE CABEÇOTE 100,0 MM	50
66113121	OM355/5 CILINDROS	JOGO DE JUNTAS COMPLETO	SEM RETENTORES	54
76113121	OM355/5 CILINDROS	JOGO DE JUNTAS COMPLETO	COM RETENTORES	54
76133121	OM355/5 CILINDROS	JOGO DE JUNTAS SUPERIOR	COM RETENTORES	54
66112501	OM355/6 CILINDROS	JOGO DE JUNTAS COMPLETO	SEM RETENTORES	58
76112501	OM355/6 CILINDROS	JOGO DE JUNTAS COMPLETO	COM RETENTORES	58
76132501	OM355/6 CILINDROS	JOGO DE JUNTAS SUPERIOR	COM RETENTORES	58
76121691	OM366	JOGO DE JUNTAS COMPLETO	COM RETENTORES E COM JUNTA DE CABEÇOTE 98,5 MM	62
76111691	OM366	JOGO DE JUNTAS COMPLETO	COM RETENTORES E COM JUNTA DE CABEÇOTE 100,0 MM	62
76121701	OM366A	JOGO DE JUNTAS COMPLETO	COM RETENTORES E COM JUNTA DE CABEÇOTE 98,5 MM	62
76141701	OM366A	JOGO DE JUNTAS COMPLETO	COM RETENTORES E COM JUNTA DE CABEÇOTE 100,0 MM	62
76112791	OM366LA	JOGO DE JUNTAS COMPLETO	COM RETENTORES E COM JUNTA DE CABEÇOTE 100,0 MM	62
76131701	OM366A/366LA	JOGO DE JUNTAS SUPERIOR	COM RETENTORES E COM JUNTA DE CABEÇOTE 98,5 MM	62
76131691	OM366A/366LA	JOGO DE JUNTAS SUPERIOR	COM RETENTORES E COM JUNTA DE CABEÇOTE 100,0 MM	62
76196115	OM447A/447LA	JOGO DE JUNTAS COMPLETO	COM RETENTORES	66
66196115	OM447A/447LA	JOGO DE JUNTAS COMPLETO	SEM RETENTORES	66
76196125	OM449A/449LA	JOGO DE JUNTAS COMPLETO	COM RETENTORES	66
66196125	OM449A/449LA	JOGO DE JUNTAS COMPLETO	SEM RETENTORES	66
76136125	OM447/OM449	JOGO DE JUNTAS MONOCILÍNDRICO	COM RETENTORES	66
66136125	OM447/OM449	JOGO DE JUNTAS MONOCILÍNDRICO	SEM RETENTORES	66
66114611	OM457LA	JOGO DE JUNTAS COMPLETO	SEM RETENTORES E SEM ANÉIS DE CAMISA (ATÉ MOTOR 32558)	68
76114611	OM457LA	JOGO DE JUNTAS COMPLETO	COM RETENTORES E SEM ANÉIS DE CAMISA (ATÉ MOTOR 32558)	68
76114619	OM457LA	JOGO DE JUNTAS COMPLETO	COM RETENTORES E COM ANÉIS DE CAMISA (ATÉ MOTOR 32558)	68
66134611	OM457LA	JOGO DE JUNTAS MONOCILÍNDRICO	SEM RETENTORES E SEM ANÉIS DE CAMISA (ATÉ MOTOR 32558)	68
76134611	OM457LA	JOGO DE JUNTAS MONOCILÍNDRICO	COM RETENTORES E SEM ANÉIS DE CAMISA (ATÉ MOTOR 32558)	68
76134619	OM457LA	JOGO DE JUNTAS MONOCILÍNDRICO	COM RETENTORES E COM ANÉIS DE CAMISA (ATÉ MOTOR 32558)	68
66114631	OM457LA	JOGO DE JUNTAS COMPLETO	SEM RETENTORES E SEM ANÉIS DE CAMISA (APÓS MOTOR 32559)	70
76114631	OM457LA	JOGO DE JUNTAS COMPLETO	COM RETENTORES E SEM ANÉIS DE CAMISA (APÓS MOTOR 32559)	70
76114639	OM457LA	JOGO DE JUNTAS COMPLETO	COM RETENTORES E COM ANÉIS DE CAMISA (APÓS MOTOR 32559)	70
76134599	OM457LA	JOGO DE JUNTAS MONOCILÍNDRICO	COM RETENTORES E COM ANÉIS DE CAMISA (APÓS MOTOR 32559)	70
76134609	OM457LA	JOGO DE JUNTAS MONOCILÍNDRICO	COM RETENTORES E COM ANÉIS DE CAMISA (APÓS MOTOR 32559)	70
76114651	OM611	JOGO DE JUNTAS COMPLETO	COM RETENTORES	72
76134651	OM611	JOGO DE JUNTAS SUPERIOR	COM RETENTORES	72
76119041	OM904	JOGO DE JUNTAS COMPLETO	COM RETENTORES PARA TAMPA DE VÁLVULAS DE PLÁSTICO	74
66119041	OM904	JOGO DE JUNTAS COMPLETO	SEM RETENTORES PARA TAMPA DE VÁLVULAS DE PLÁSTICO	74
76119241	OM924	JOGO DE JUNTAS COMPLETO	COM RETENTORES PARA TAMPA DE VÁLVULAS DE PLÁSTICO	74
66119241	OM924	JOGO DE JUNTAS COMPLETO	SEM RETENTORES PARA TAMPA DE VÁLVULAS DE PLÁSTICO	74
76139041	OM904	JOGO DE JUNTAS SUPERIOR	COM RETENTORES PARA TAMPA DE VÁLVULAS DE PLÁSTICO	74
76139241	OM904	JOGO DE JUNTAS SUPERIOR	COM RETENTORES PARA TAMPA DE VÁLVULAS DE PLÁSTICO	74
76119061	OM906	JOGO DE JUNTAS COMPLETO	COM RETENTORES PARA TAMPA DE VÁLVULAS DE PLÁSTICO	76
66119061	OM906	JOGO DE JUNTAS COMPLETO	SEM RETENTORES PARA TAMPA DE VÁLVULAS DE PLÁSTICO	76
76119261	OM926	JOGO DE JUNTAS COMPLETO	COM RETENTORES PARA TAMPA DE VÁLVULAS DE PLÁSTICO	76
66119291	OM926	JOGO DE JUNTAS COMPLETO	SEM RETENTORES PARA TAMPA DE VÁLVULAS DE PLÁSTICO	76
76136061	OM906	JOGO DE JUNTAS SUPERIOR	COM RETENTORES PARA TAMPA DE VÁLVULAS DE PLÁSTICO	76
76139261	OM926	JOGO DE JUNTAS SUPERIOR	COM RETENTORES PARA TAMPA DE VÁLVULAS DE PLÁSTICO	76
76114682	OM612	JOGO DE JUNTAS COMPLETO	COM RETENTORES E COM FLANGE TRASEIRA	78
76134682	OM612	JOGO DE JUNTAS SUPERIOR	COM RETENTORES	78
76112702	OM651	JOGO DE JUNTAS COMPLETO	COM RETENTORES	80
76132702	OM651	JOGO DE JUNTAS SUPERIOR	COM RETENTORES	80
76114735	OM501(MOTOR 012091 ATÉ 084423)	JOGO DE JUNTAS COMPLETO	COM RETENTORES SEM ANEL DE CAMISA	82
76114745	OM501(MOTOR 084424 ATÉ 155295)	JOGO DE JUNTAS COMPLETO	COM RETENTORES SEM ANEL DE CAMISA	82
76114715	OM501(MOTOR 155296 ATÉ 377748)	JOGO DE JUNTAS COMPLETO	COM RETENTORES SEM ANEL DE CAMISA	82
76114725	OM501(APÓS MOTOR 377749)	JOGO DE JUNTAS COMPLETO	COM RETENTORES SEM ANEL DE CAMISA	82

Nº ABR	MOTOR	DESCRIÇÃO	PÁGINA
76134735	OM501/502(MOTOR 012091 ATÉ 084423)	JOGO DE JUNTAS SUPERIOR	COM RETENTORES 82
76134745	OM501/502 (MOTOR 084424 ATÉ 155295)	JOGO DE JUNTAS SUPERIOR	COM RETENTORES 82
76134715	OM501/502 (MOTOR 155296 ATÉ 377748)	JOGO DE JUNTAS SUPERIOR	COM RETENTORES 82
76134725	OM501/502 (APÓS MOTOR 377749)	JOGO DE JUNTAS SUPERIOR	COM RETENTORES 82
76134730	OM501 TODOS OS MOTORES	JOGO DE JUNTAS INFERIOR	COM RETENTORES SEM JUNTA DE CÁRTER 82
76134720	OM501 (ATÉ MOTOR 012090)	JOGO DE JUNTAS INFERIOR	COM RETENTORES COM JUNTA DE CÁRTER SOFT 82
76134710	OM501 (APÓS MOTOR 012091)	JOGO DE JUNTAS INFERIOR	COM RETENTORES COM JUNTA DE CÁRTER BORRACHA 82
76114755	OM502 (MOTOR 012091 ATÉ 084423)	JOGO DE JUNTAS COMPLETO	COM RETENTORES SEM ANEL DE CAMISA 84
76114765	OM502 (MOTOR 084424 ATÉ 155295)	JOGO DE JUNTAS COMPLETO	COM RETENTORES SEM ANEL DE CAMISA 84
76114775	OM502 (MOTOR 155296 ATÉ 377748)	JOGO DE JUNTAS COMPLETO	COM RETENTORES SEM ANEL DE CAMISA 84
76114785	OM502 (APÓS MOTOR 377749)	JOGO DE JUNTAS COMPLETO	COM RETENTORES SEM ANEL DE CAMISA 84
76134735	OM501/502 (MOTOR 012091 ATÉ 084423)	JOGO DE JUNTAS SUPERIOR	COM RETENTORES 84
76134745	OM501/502 (MOTOR 084424 ATÉ 155295)	JOGO DE JUNTAS SUPERIOR	COM RETENTORES 84
76134715	OM501/502 (MOTOR 155296 ATÉ 377748)	JOGO DE JUNTAS SUPERIOR	COM RETENTORES 84
76134725	OM501/502 (APÓS MOTOR 377749)	JOGO DE JUNTAS SUPERIOR	COM RETENTORES 84
76134760	OM502 (TODOS)	JOGO DE JUNTAS INFERIOR	COM RETENTORES SEM JUNTA DE CÁRTER 84
76134750	OM502 (ATÉ MOTOR 012090)	JOGO DE JUNTAS INFERIOR	COM RETENTORES COM JUNTA DE CÁRTER SOFT 84
76134740	OM502 (APÓS MOTOR 012091)	JOGO DE JUNTAS INFERIOR	COM RETENTORES COM JUNTA DE CÁRTER BORRACHA 84

MWM

Nº ABR	MOTOR	DESCRIÇÃO	PÁGINA
64311871	D226	JOGO DE JUNTAS COMPLETO	SEM RETENTORES 88
74311871	D226	JOGO DE JUNTAS COMPLETO	COM RETENTORES 88
64314181	D229 4 CILINDROS	JOGO DE JUNTAS COMPLETO	SEM RETENTORES 90
74314181	D229 4 CILINDROS	JOGO DE JUNTAS COMPLETO	COM RETENTORES 90
64314193	TD229 4 CILINDROS	JOGO DE JUNTAS COMPLETO	SEM RETENTORES 90
74314193	TD229 4 CILINDROS	JOGO DE JUNTAS COMPLETO	COM RETENTORES 90
64414543	TD229 4 CILINDROS	JOGO DE JUNTAS COMPLETO	SEM RETENTORES 90
74414543	TD229 4 CILINDROS	JOGO DE JUNTAS COMPLETO	COM RETENTORES 90
64315061	X10 4 CILINDROS	JOGO DE JUNTAS COMPLETO	SEM RETENTORES 94
74315061	X10 4 CILINDROS	JOGO DE JUNTAS COMPLETO	COM RETENTORES 94
64315071	X10 6 CILINDROS	JOGO DE JUNTAS COMPLETO	SEM RETENTORES 94
74315071	X10 6 CILINDROS	JOGO DE JUNTAS COMPLETO	COM RETENTORES 94
64315032	412TCE X12 4 CILINDROS	JOGO DE JUNTAS COMPLETO	SEM RETENTORES COM ANÉIS DE CAMISA 98
74315032	412TCE X12 4 CILINDROS	JOGO DE JUNTAS COMPLETO	COM RETENTORES COM ANÉIS DE CAMISA 98
64315042	612TCE X12 6 CILINDROS	JOGO DE JUNTAS COMPLETO	SEM RETENTORES COM ANÉIS DE CAMISA 98
74315042	612TCE X12 6 CILINDROS	JOGO DE JUNTAS COMPLETO	COM RETENTORES COM ANÉIS DE CAMISA 98
64315083	4.07 TCA	JOGO DE JUNTAS COMPLETO	SEM RETENTORES 102
74315083	4.07 TCA	JOGO DE JUNTAS COMPLETO	COM RETENTORES 102
74385081	4.07 TCA	JOGO DE JUNTAS SUPERIOR	COM RETENTORES 102
64315103	4.07/4.08 TCE ELETRÔNICO	JOGO DE JUNTAS COMPLETO	SEM RETENTORES 102
74315103	4.07/4.08 TCE ELETRÔNICO	JOGO DE JUNTAS COMPLETO	COM RETENTORES 102
74335103	4.07/4.08 TCE ELETRÔNICO	JOGO DE JUNTAS SUPERIOR	COM RETENTORES 102
64315093	6.07 TCA	JOGO DE JUNTAS COMPLETO	SEM RETENTORES 106
74315093	6.07 TCA	JOGO DE JUNTAS COMPLETO	COM RETENTORES 106
64315145	MAXFORCE X12 4 CILINDROS	JOGO DE JUNTAS COMPLETO	SEM RETENTORES 110
74315145	MAXFORCE X12 4 CILINDROS	JOGO DE JUNTAS COMPLETO	COM RETENTORES 110
74335145	MAXFORCE X12 4 CILINDROS	JOGO DE JUNTAS SUPERIOR	COM RETENTORES 110
64315165	MAXFORCE X12 6 CILINDROS	JOGO DE JUNTAS COMPLETO	SEM RETENTORES 110
74315165	MAXFORCE X12 6 CILINDROS	JOGO DE JUNTAS COMPLETO	COM RETENTORES 110
74335165	MAXFORCE X12 6 CILINDROS	JOGO DE JUNTAS SUPERIOR	COM RETENTORES 110
84335465	MAXFORCE X12	JOGO DE JUNTAS MONOCILINDRICO	COM RETENTORES 110

MAXION PERKINS

Nº ABR	MOTOR	DESCRIÇÃO		PÁGINA
70910572	NGD 3.0	JOGO DE JUNTAS COMPLETO	COM RETENTORES	116
70930572	NGD 3.0	JOGO DE JUNTAS SUPERIOR	COM RETENTORES	116
60910359	3152	JOGO DE JUNTAS COMPLETO	SEM RETENTORES E COM INJEÇÃO INDIRETA	118
70910359	3152	JOGO DE JUNTAS COMPLETO	COM RETENTORES E COM INJEÇÃO INDIRETA	118
70930359	3152	JOGO DE JUNTAS COMPLETO	COM RETENTORES E COM INJEÇÃO INDIRETA	118
60910361	D3152	JOGO DE JUNTAS COMPLETO	SEM RETENTORES E COM INJEÇÃO INDIRETA	124
70910361	D3152	JOGO DE JUNTAS COMPLETO	COM RETENTORES E COM INJEÇÃO INDIRETA	124
60930361	D3152	JOGO DE JUNTAS COMPLETO	SEM RETENTORES E COM INJEÇÃO INDIRETA	118
70910831	4203	JOGO DE JUNTAS COMPLETO	SEM RETENTORES E COM INJEÇÃO INDIRETA	122
70932931	4203	JOGO DE JUNTAS COMPLETO	SEM RETENTORES E COM INJEÇÃO INDIRETA	128
60912931	4203	JOGO DE JUNTAS COMPLETO	SEM RETENTORES E COM INJEÇÃO INDIRETA	128
70912931	4203	JOGO DE JUNTAS COMPLETO	SEM RETENTORES E COM INJEÇÃO INDIRETA	122
60913001	4203	JOGO DE JUNTAS COMPLETO	SEM RETENTORES E COM INJEÇÃO INDIRETA	126
70913001	4203	JOGO DE JUNTAS COMPLETO	SEM RETENTORES E COM INJEÇÃO INDIRETA	132
70932791	4203	JOGO DE JUNTAS SUPERIOR	SEM RETENTORES E COM INJEÇÃO INDIRETA	126
60912981	D4236/4238	JOGO DE JUNTAS COMPLETO	SEM RETENTORES	130
70912981	D4236/4238	JOGO DE JUNTAS COMPLETO	COM RETENTORES	136
70913981	T4236	JOGO DE JUNTAS COMPLETO	COM RETENTORES	136
60913031	T4236	JOGO DE JUNTAS COMPLETO	SEM RETENTORES	130
60916151	D4236/4248	JOGO DE JUNTAS COMPLETO	SEM RETENTORES	134
70916151	D4236/4248	JOGO DE JUNTAS COMPLETO	COM RETENTORES	140
70916151	4236 / 4248	JOGO DE JUNTAS COMPLETO	COM RETENTORES	140
70933031	4236 / 4248	JOGO DE JUNTAS SUPERIOR	COM RETENTORES	134
70930051	4236 / 4248	JOGO DE JUNTAS COMPLETO	COM RETENTORES	138
60910151	Q20B/4236	JOGO DE JUNTAS COMPLETO	SEM RETENTORES	144
70910151	Q20B/4236	JOGO DE JUNTAS COMPLETO	COM RETENTORES	144
60930051	Q20B/D4236/4248	JOGO DE JUNTAS COMPLETO	SEM RETENTORES	138
70930051	Q20B/D4236/4248	JOGO DE JUNTAS COMPLETO	COM RETENTORES	142
60914763		JOGO DE JUNTAS COMPLETO	SEM RETENTORES	148
70914763		JOGO DE JUNTAS COMPLETO	COM RETENTORES	148
60934763		JOGO DE JUNTAS SUPERIOR	SEM RETENTORES	148
60914053		JOGO DE JUNTAS COMPLETO	SEM RETENTORES	148
70914053		JOGO DE JUNTAS COMPLETO	COM RETENTORES	142
60934053		JOGO DE JUNTAS SUPERIOR	SEM RETENTORES	146
60914753	P4000/94000T	JOGO DE JUNTAS COMPLETO	SEM RETENTORES	152
70914753	P4000/94000T	JOGO DE JUNTAS COMPLETO	COM RETENTORES	146
70934751	P4000/94000T	JOGO DE JUNTAS COMPLETO	COM RETENTORES E COM HASTE DE VÁLVULA	150
60914733	S4/S4T	JOGO DE JUNTAS COMPLETO	COM RETENTORES	156
70914733	S4/S4T	JOGO DE JUNTAS COMPLETO	COM RETENTORES	150
70934731	S4/S4T	JOGO DE JUNTAS SUPERIOR	COM RETENTORES E COM HASTE DE VÁLVULA	154
60914773	HS 2.5	JOGO DE JUNTAS COMPLETO	SEM RETENTORES	160
70914773	HS 2.5	JOGO DE JUNTAS COMPLETO	COM RETENTORES	160
60934773	HS 2.5	JOGO DE JUNTAS SUPERIOR	SEM RETENTORES	154
70934773	HS 2.5	JOGO DE JUNTAS SUPERIOR	COM RETENTORES E COM HASTE DE VÁLVULA	158
60914873	HS 2.8	JOGO DE JUNTAS COMPLETO	COM RETENTORES	164
70914873	HS 2.8	JOGO DE JUNTAS COMPLETO	COM RETENTORES	164
60934873	HS 2.8	JOGO DE JUNTAS SUPERIOR	COM RETENTORES	158
70934873	HS 2.8	JOGO DE JUNTAS SUPERIOR	COM RETENTORES	162
60913761	P6354.4	JOGO DE JUNTAS COMPLETO	COM RETENTORES	168
70913761	P6354.4	JOGO DE JUNTAS COMPLETO	COM RETENTORES	168
70933761	P6354.4	JOGO DE JUNTAS SUPERIOR	COM RETENTORES E COM HASTE DE VÁLVULA	162
60913763	P6354.4	JOGO DE JUNTAS COMPLETO	SEM RETENTORES	166
60913761	P6354.4	JOGO DE JUNTAS COMPLETO	SEM RETENTORES	172
70913761	P6354.4	JOGO DE JUNTAS COMPLETO	COM RETENTORES	172
70933761	P6354.4	JOGO DE JUNTAS COMPLETO	COM RETENTORES	166
60913763	P6354.4	JOGO DE JUNTAS SUPERIOR	SEM RETENTORES	170
60912881	P6357	JOGO DE JUNTAS COMPLETO	COM RETENTORES	176
70912881	P6357	JOGO DE JUNTAS COMPLETO	COM RETENTORES	170
70932881	P6357	JOGO DE JUNTAS SUPERIOR	COM RETENTORES	174
60913439	P6358	JOGO DE JUNTAS COMPLETO	SEM RETENTORES	174
70913439	P6358	JOGO DE JUNTAS COMPLETO	COM RETENTORES	174
70933431	P6358	JOGO DE JUNTAS SUPERIOR	COM RETENTORES	174

IVECO

Nº ABR	MOTOR	DESCRIÇÃO	PÁGINA
63510101	DUCATO 2.5/2.8	JOGO DE JUNTAS COMPLETO SEM RETENTORES	180
73510121	DUCATO 2.5/2.8	JOGO DE JUNTAS COMPLETO COM RETENTORES	180
63510121	DUCATO 2.5/2.8	JOGO DE JUNTAS SUPERIOR SEM RETENTORES	180
73510121	DUCATO 2.5/2.8	JOGO DE JUNTAS SUPERIOR COM RETENTORES	180
73530101	DUCATO 2.5/2.8	JOGO DE JUNTAS INFERIOR SEM RETENTORES	180
73510131	DUCATO 2.8	JOGO DE JUNTAS INFERIOR COM INJEÇÃO INDIRETA E COM RETENTORES	184
63540131	DUCATO 2.8	JOGO DE JUNTAS COMPLETO COM INJEÇÃO INDIRETA E SEM RETENTORES	184
73540131	DUCATO 2.8	JOGO DE JUNTAS SUPERIOR COM INJEÇÃO INDIRETA E SEM RETENTORES	184
73530101	DUCATO 2.5/2.8	JOGO DE JUNTAS INFERIOR COM INJEÇÃO INDIRETA E SEM RETENTORES	184
73510162	JTD 2.3	JOGO DE JUNTAS COMPLETO SEM RETENTORES	188
73530162	JTD 2.3	JOGO DE JUNTAS COMPLETO COM RETENTORES	188
73510182	F1CE0481D	JOGO DE JUNTAS SUPERIOR SEM RETENTORES	190
73530182	F1CE0481D	JOGO DE JUNTAS SUPERIOR COM RETENTORES	190
73510202	CURSOR 8	JOGO DE JUNTAS INFERIOR SEM RETENTORES	192
73530202	CURSOR 8	JOGO DE JUNTAS INFERIOR COM RETENTORES	192
73510252	CURSOR 9	JOGO DE JUNTAS COMPLETO SEM RETENTORES	194
73530252	CURSOR 9	JOGO DE JUNTAS COMPLETO COM RETENTORES	194
73510352	CURSOR 10	JOGO DE JUNTAS SUPERIOR SEM RETENTORES	196
73530352	CURSOR 10	JOGO DE JUNTAS SUPERIOR COM RETENTORES	196
73510302	CURSOR 13	JOGO DE JUNTAS INFERIOR SEM RETENTORES	198
73530302	CURSOR 13	JOGO DE JUNTAS INFERIOR COM RETENTORES	198

SCANIA

Nº ABR	MOTOR	DESCRIÇÃO	PÁGINA
73716300	DN11/DS11	JOGO DE JUNTAS COMPLETO COM RETENTORES COM ANÉIS DE CAMISA	204
63714745	DN11/DS11	JOGO DE JUNTAS COMPLETO SEM RETENTORES SEM ANÉIS DE CAMISA	204
73714745	DN11/DS11	JOGO DE JUNTAS COMPLETO COM RETENTORES COM ANÉIS DE CAMISA	204
63734745	DN11/DS11	JOGO DE JUNTAS SUPERIOR SEM RETENTORES SEM ANÉIS DE CAMISA	204
73796310	DS11/DSC11	JOGO DE JUNTAS COMPLETO SEM RETENTORES SEM ANÉIS DE CAMISA	208
63796315	DS11/DSC11	JOGO DE JUNTAS COMPLETO COM RETENTORES SEM ANÉIS DE CAMISA	208
73796315	DS11/DSC11	JOGO DE JUNTAS SUPERIOR COM RETENTORES COM ANÉIS DE CAMISA	208
63736345	DS11/DSC11	JOGO DE JUNTAS SUPERIOR SEM RETENTORES SEM ANÉIS DE CAMISA	208
73710430	DN11/DS11/DSC11	JOGO DE JUNTAS COMPLETO COM RETENTORES COM ANÉIS DE CAMISA	212
63710435	DN11/DS11/DSC11	JOGO DE JUNTAS COMPLETO SEM RETENTORES SEM ANÉIS DE CAMISA	212
73710435	DN11/DS11/DSC11	JOGO DE JUNTAS COMPLETO COM RETENTORES SEM ANÉIS DE CAMISA	216
63730435	DN11/DS11/DSC11	JOGO DE JUNTAS SUPERIOR SEM RETENTORES SEM ANÉIS DE CAMISA	216
63710129	DC11	JOGO DE JUNTAS COMPLETO SEM RETENTORES COM ANÉIS DE CAMISA	220
73710129	DC11	JOGO DE JUNTAS COMPLETO COM RETENTORES COM ANÉIS DE CAMISA	220
63710429	DSC12	JOGO DE JUNTAS COMPLETO SEM RETENTORES COM ANÉIS DE CAMISA	220
73710429	DSC12	JOGO DE JUNTAS COMPLETO COM RETENTORES COM ANÉIS DE CAMISA	220
63710109	DSC12	JOGO DE JUNTAS COMPLETO SEM RETENTORES COM ANÉIS DE CAMISA	220
73710109	DSC12	JOGO DE JUNTAS COMPLETO COM RETENTORES COM ANÉIS DE CAMISA	220
63730121	DC11	JOGO DE JUNTAS MONOCILÍNDRICO SEM RETENTORES SEM ANÉIS DE CAMISA	224
73730121	DC11	JOGO DE JUNTAS MONOCILÍNDRICO COM RETENTORES SEM ANÉIS DE CAMISA	224
63730421	DSC12	JOGO DE JUNTAS MONOCILÍNDRICO SEM RETENTORES SEM ANÉIS DE CAMISA	224
73730421	DSC12	JOGO DE JUNTAS MONOCILÍNDRICO COM RETENTORES SEM ANÉIS DE CAMISA	224
63730101	DSC12	JOGO DE JUNTAS MONOCILÍNDRICO SEM RETENTORES SEM ANÉIS DE CAMISA	224
73730101	DSC12	JOGO DE JUNTAS MONOCILÍNDRICO COM RETENTORES SEM ANÉIS DE CAMISA	224
73712535	DS14/LK140/LK141	JOGO DE JUNTAS COMPLETO COM RETENTORES SEM ANÉIS DE CAMISA	226
63732535	DS14/LK140/LK141	JOGO DE JUNTAS MONOCILÍNDRICO SEM RETENTORES SEM ANÉIS DE CAMISA	226

JOHN DEERE

Nº ABR	MOTOR	DESCRIÇÃO	PÁGINA
60210401	3029D	JOGO DE JUNTAS COMPLETO SEM RETENTORES	230
70210401	3029D	JOGO DE JUNTAS COMPLETO COM RETENTORES	230
60230401	3029D	JOGO DE JUNTAS SUPERIOR SEM RETENTORES	230
60210301	4045T	JOGO DE JUNTAS COMPLETO SEM RETENTORES	232
70210301	4045T	JOGO DE JUNTAS COMPLETO COM RETENTORES	232
60230301	4045T	JOGO DE JUNTAS SUPERIOR SEM RETENTORES	232
60210201	6068D	JOGO DE JUNTAS COMPLETO SEM RETENTORES	234
70210201	6068D	JOGO DE JUNTAS COMPLETO COM RETENTORES	234
60230201	6068D	JOGO DE JUNTAS SUPERIOR SEM RETENTORES	234
60210501	6090T	JOGO DE JUNTAS COMPLETO SEM RETENTORES	236
70210501	6090T	JOGO DE JUNTAS COMPLETO COM RETENTORES	236
60230501	6090T	JOGO DE JUNTAS SUPERIOR SEM RETENTORES	236
60210601	6081T	JOGO DE JUNTAS COMPLETO SEM RETENTORES	238
60230601	6081T	JOGO DE JUNTAS SUPERIOR SEM RETENTORES	238

Nº ABR	MOTOR	DESCRIÇÃO		PÁGINA
60210701	6076T	JOGO DE JUNTAS COMPLETO	SEM RETENTORES	240
60230701	6076T	JOGO DE JUNTAS SUPERIOR	SEM RETENTORES	240

FORD

Nº ABR	MOTOR	DESCRIÇÃO		PÁGINA
64113401	4630	JOGO DE JUNTAS COMPLETO	SEM RETENTORES	244
74113401	4630	JOGO DE JUNTAS COMPLETO	COM RETENTORES	244
64133401	4630	JOGO DE JUNTAS SUPERIOR	SEM RETENTORES	244
74133401	4630	JOGO DE JUNTAS SUPERIOR	COM RETENTORES	244
64113301	4600/4610/4810	JOGO DE JUNTAS COMPLETO	SEM RETENTORES	248
74113301	4600/4610/4810	JOGO DE JUNTAS COMPLETO	COM RETENTORES	248
64133301	4600/4610/4810	JOGO DE JUNTAS SUPERIOR	SEM RETENTORES	248
74133301	4600/4610/4810	JOGO DE JUNTAS SUPERIOR	COM RETENTORES	248
64113601	F4000/6600/7610	JOGO DE JUNTAS COMPLETO	SEM RETENTORES	252
74113601	F4000/6600/7610	JOGO DE JUNTAS COMPLETO	COM RETENTORES	252
64133601	F4000/6600/7610	JOGO DE JUNTAS SUPERIOR	SEM RETENTORES	252
64114361 TEM	F4000/6600/7610	JOGO DE JUNTAS COMPLETO	SEM RETENTORES	252
64114361	F4000/5610/6600/6610	JOGO DE JUNTAS COMPLETO	SEM RETENTORES	256
64113181	F4000/5610/6600/6610	JOGO DE JUNTAS COMPLETO	COM RETENTORES	256
74113181	F4000/5610/6600/6610	JOGO DE JUNTAS COMPLETO	SEM RETENTORES	256
64133181	F4000/5610/6600/6610	JOGO DE JUNTAS SUPERIOR	SEM RETENTORES	256
64113651	7630	JOGO DE JUNTAS COMPLETO	SEM RETENTORES	260
74113651	7630	JOGO DE JUNTAS COMPLETO	COM RETENTORES	260
64133651	7630	JOGO DE JUNTAS COMPLETO	SEM RETENTORES	260
64113501	5030/5630/6630	JOGO DE JUNTAS COMPLETO	SEM RETENTORES	260
74113501	5030/5630/6630	JOGO DE JUNTAS COMPLETO	COM RETENTORES	260
64133501	7630	JOGO DE JUNTAS COMPLETO	SEM RETENTORES	260
64111093	7830/8030	JOGO DE JUNTAS COMPLETO	SEM RETENTORES	264
74111093	7830/8030	JOGO DE JUNTAS COMPLETO	COM RETENTORES	264
64133091	7830/8030	JOGO DE JUNTAS SUPERIOR	SEM RETENTORES	264
64111081	FASE 1	JOGO DE JUNTAS COMPLETO	SEM RETENTORES	266
74111081	FASE 1	JOGO DE JUNTAS SUPERIOR	COM RETENTORES	266
64131081	FASE 1	JOGO DE JUNTAS SUPERIOR	SEM RETENTORES	266
64131061	FASE 2	JOGO DE JUNTAS SUPERIOR	SEM RETENTORES	266
64111061	FASE 2	JOGO DE JUNTAS COMPLETO	SEM RETENTORES	266
74111061	FASE 2	JOGO DE JUNTAS COMPLETO	COM RETENTORES	266
64115132	TRANSIT 2.4 TDCI	JOGO DE JUNTAS COMPLETO	SEM RETENTORES	270
74115132	TRANSIT 2.4 TDCI	JOGO DE JUNTAS COMPLETO	COM RETENTORES	270
64135132	TRANSIT 2.4 TDCI	JOGO DE JUNTAS SUPERIOR	SEM RETENTORES	270
74135132	TRANSIT 2.4 TDCI	JOGO DE JUNTAS SUPERIOR	COM RETENTORES	270
64115142	OUMA 3.2 TDCI	JOGO DE JUNTAS COMPLETO	SEM RETENTORES	272
74115142	OUMA 3.2 TDCI	JOGO DE JUNTAS COMPLETO	COM RETENTORES	272
64135142	OUMA 3.2 TDCI	JOGO DE JUNTAS SUPERIOR	SEM RETENTORES	272
74135142	OUMA 3.2 TDCI	JOGO DE JUNTAS SUPERIOR	COM RETENTORES	272
74115282	TRANSIT 2.2	JOGO DE JUNTA COMPLETO	COM RETENTORES	274
74118282	TRANSIT 2.2	JOGO DE JUNTA COMPLETO	COM RETENTORES	274

VALTRA

Nº ABR	MOTOR	DESCRIÇÃO		PÁGINA
64410121	420 DS	JOGO DE JUNTAS COMPLETO	SEM RETENTORES	278
64410141	420 DS	JOGO DE JUNTAS COMPLETO	SEM RETENTORES	278
64430121	420 DS	JOGO DE JUNTAS SUPERIOR	SEM RETENTORES	278
74410121	420 DS	JOGO DE JUNTAS COMPLETO	COM RETENTORES	278
74410141	420 DS	JOGO DE JUNTAS COMPLETO	COM RETENTORES	278
64410131	620 DS	JOGO DE JUNTAS COMPLETO	SEM RETENTORES	282
64410151	620 DS	JOGO DE JUNTAS COMPLETO	SEM RETENTORES	282
64430131	620 DS	JOGO DE JUNTAS SUPERIOR	SEM RETENTORES	282
64410161	620 DS	JOGO DE JUNTAS COMPLETO	SEM RETENTORES	282
64430161	620 DS	JOGO DE JUNTAS SUPERIOR	SEM RETENTORES	282
74410161	620 DS	JOGO DE JUNTAS SUPERIOR	COM RETENTORES	282

LEGENDAS E ESPECIFICAÇÕES

CÓDIGO DO MATERIAL	MATERIAL	DESCRIÇÃO - JUNTAS DE CABEÇOTE
00	HTM-S	HIGH TORQUE RETENTION MATERIAL - SOLID
01	HTM-P	HIGH TORQUE RETENTION MATERIAL - PERFORATED
02	ML	MULTI - LAYER
03	HTM-PT	HIGH TORQUE RETENTION MATERIAL - PERFORATED TURBO
04	HTM-P	HIGH TORQUE RETENTION MATERIAL - PERFORATED
05	HTM-ME	HTM - METAL - ELASTÔMERO BORRACHA
CÓDIGO DO MATERIAL	MATERIAL	DESCRIÇÃO - JUNTAS DE CABEÇOTE
16	HTM-P	HIGH TORQUE RETENTION MATERIAL - PERFORATED
17 OU 18	FF	FOLHA DE AÇO / PH / FOLHA DE AÇO
19	LT	LATÃO
20 / 24	CU	COBRE
25 / 29	AL	ALUMÍNIO
30 / 39	AC	AÇO OU METAL COM BORRACHA
31		WOLVERINE
40 / 45	BO	BORRACHA
47	HTM-P	HIGH TORQUE RETENTION MATERIAL - PERFORATED

CÓDIGO DO MATERIAL	MATERIAL	DESCRIÇÃO - JUNTAS DIVERSAS
48	GX	GAXETA
49	RT	RETENTOR
50 / 58	CE	CORTIÇA COM BORRACHA
59	CL	CORTIÇA COM BORRACHA COM LONA
60 / 64	FI	FIBRAS
65	FE	FELTRO
66	PVC	PVC
67	PH	PAPELÃO HIDRÁULICO
68	BQT	BAQUELITE REVESTIDO COM PH
70 / 73	PP	PRESBAN
75	PK	PAPEL KRAFT
77	PH	PAPELÃO HIDRÁULICO ALTERNATIVO
80 / 89	GA	GUARNITAL
90 / 99	PH	PAPELÃO HIDRÁULICO

O CÓDIGO DE IDENTIFICAÇÃO DAS PEÇAS FABRICADAS PELA ABR É COMPOSTO DA NUMERAÇÃO CONFORME EXEMPLOS ABAIXO :

1) NO CASO DE JUNTAS AVULSAS: JUNTA DO CÂRTER FIRE 5 . 73 . 856 . 40

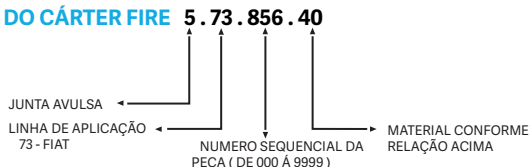

2) NO CASO DE JUNTAS: JOGO COMPLETO FIAT FIRE 1.0/1.3 8 VÁLVULAS 6 . 73 . 1 605 . 1

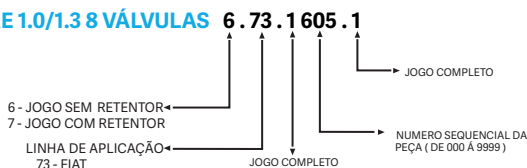

INFORMAÇÕES COMPLEMENTARES SOBRE CÓDIGOS DE IDENTIFICAÇÃO DOS JOGOS DE JUNTAS:

1 DÍGITO	6 - INDICA JOGOS SEM RETENTORES / PARCIAIS
	7 - INDICA JOGOS COM RETENTORES / PARCIAIS
	8 - INDICA JOGOS DIVERSOS : CARTER, CÂMBIO, TURBINA, E.T.C
4 DÍGITO	1 - INDICA JOGO COMPLETO
	3 - INDICA JOGO SUPERIOR / INFEIOR
8 DÍGITO	1 OU 3 - INDICA JOGO COMPLETO / SUPERIOR
	0 - INDICA JOGO INFEIOR

TODOS OS NOMES E LOGOMARCAS DE TERCEIROS APRESENTADOS NESTE CÁTALOGO, SÃO PROPRIEDADE DE SUAS RESPECTIVAS EMPRESAS. TODOS OS DIREITOS RESERVADOS. ESTE CÁTALOGO NÃO PODERÁ SER REPRODUZIDO, ARQUIVADO OU UTILIZADO, NEM COPIADO POR QUALQUER MEIO, ELETRÔNICO, IMPRESSO, FOTOCOPIADO, GRAVADO, RETRABALHADO OU QUALQUER OUTRO MEIO, SEM PERMISSÃO PRÉVIA DA ABR INDÚSTRIA E COMÉRCIO DE AUTO PEÇAS LTDA. TODAS AS INFORMAÇÕES CONTIDAS NESTE CÁTALOGO FORAM EXTRAÍDAS DE FONTES SEGURAS. RAS. APESAR DE TODO NOSSO ESFORÇO EM PREPARAR UM CÁTALOGO ALTAMENTE CONFIÁVEL, NÃO PODEMOS GARANTIR TOTAL EXATIDÃO NAS INFORMAÇÕES, E POR CONSEQUÊNCIA, NÃO NOS RESPONSABILIZAMOS POR EVENTUAIS ERROS, OMISSÕES, BEM COMO DANOS OU PERDAS QUE POSSAM OCORRER.



CUMMINS

Nº ABR	MOTOR	DESCRIÇÃO	PÁGINA
68313943	4B/4BT	JOGO DE JUNTAS COMPLETO SEM RETENTORES	18
78313943	4B/4BT	JOGO DE JUNTAS COMPLETO COM RETENTORES	18
68333941	4B/4BT	JOGO DE JUNTAS SUPERIOR SEM RETENTORES	18
78333941	4B/4BT	JOGO DE JUNTAS SUPERIOR COM RETENTORES	18
68333940	4B/4BT	JOGO DE JUNTAS INFERIOR SEM RETENTORES	18
78333940	4B/4BT	JOGO DE JUNTAS INFERIOR COM RETENTORES	18
78310643	ISBe4 3.9L	JOGO DE JUNTAS COMPLETO COM RETENTORES	20
78330641	ISBe4 3.9L	JOGO DE JUNTAS SUPERIOR COM RETENTORES	20
78330640	ISBe4 3.9L	JOGO DE JUNTAS INFERIOR COM RETENTORES	20
68315943	6B/6BT	JOGO DE JUNTAS COMPLETO SEM RETENTORES	22
78315943	6B/6BT	JOGO DE JUNTAS COMPLETO COM RETENTORES	22
68335941	6B/6BT	JOGO DE JUNTAS SUPERIOR SEM RETENTORES	22
78335941	6B/6BT	JOGO DE JUNTAS SUPERIOR COM RETENTORES	22
68335940	6B/6BT	JOGO DE JUNTAS INFERIOR SEM RETENTORES	22
78335940	6B/6BT	JOGO DE JUNTAS INFERIOR COM RETENTORES	24
68310663	ISBe6 5.9L	JOGO DE JUNTAS COMPLETO SEM RETENTORES	24
78310663	ISBe6 5.9L	JOGO DE JUNTAS COMPLETO COM RETENTORES	24
68330661	ISBe6 5.9L	JOGO DE JUNTAS SUPERIOR SEM RETENTORES	24
78330661	ISBe6 5.9L	JOGO DE JUNTAS SUPERIOR COM RETENTORES	24
68330660	ISBe6 5.9L	JOGO DE JUNTAS INFERIOR SEM RETENTORES	24
78330660	ISBe6 5.9L	JOGO DE JUNTAS INFERIOR COM RETENTORES	24
68314943	6C/6CTA	JOGO DE JUNTAS COMPLETO SEM RETENTORES	26
78314943	6C/6CTA	JOGO DE JUNTAS COMPLETO COM RETENTORES	26
68334941	6C/6CTA	JOGO DE JUNTAS SUPERIOR SEM RETENTORES	26
78334941	6C/6CTA	JOGO DE JUNTAS SUPERIOR COM RETENTORES	26
68334940	6C/6CTA	JOGO DE JUNTAS INFERIOR SEM RETENTORES	26
78334940	6C/6CTA	JOGO DE JUNTAS INFERIOR COM RETENTORES	26
78314949	6C/6CTA	JOGO DE JUNTAS COMPLETO COM RETENTORES COM ANÉIS DE CAMISA	26
78334949	6C/6CTA	JOGO DE JUNTAS INFERIOR COM RETENTORES COM ANÉIS DE CAMISA	26
68310593	ISC 8.3L/ ISL 8.9L	JOGO DE JUNTAS COMPLETO SEM RETENTORES	30
78310593	ISC 8.3L/ ISL 8.9L	JOGO DE JUNTAS COMPLETO COM RETENTORES	30
68330591	ISC 8.3L/ ISL 8.9L	JOGO DE JUNTAS SUPERIOR SEM RETENTORES	30
78330591	ISC 8.3L/ ISL 8.9L	JOGO DE JUNTAS SUPERIOR COM RETENTORES	30
68330590	ISC 8.3L/ ISL 8.9L	JOGO DE JUNTAS INFERIOR SEM RETENTORES	30
78330590	ISC 8.3L/ ISL 8.9L	JOGO DE JUNTAS INFERIOR COM RETENTORES	30
68310772	ISB4.5 / QSB4.5	JOGO DE JUNTAS COMPLETO SEM RETENTORES	32
78310772	ISB4.5 / QSB4.5	JOGO DE JUNTAS COMPLETO COM RETENTORES	32
68330771	ISB4.5 / QSB4.5	JOGO DE JUNTAS SUPERIOR SEM RETENTORES	32
78330771	ISB4.5 / QSB4.5	JOGO DE JUNTAS SUPERIOR COM RETENTORES	32
68330770	ISB4.5 / QSB4.5	JOGO DE JUNTAS INFERIOR SEM RETENTORES	32
78330770	ISB4.5 / QSB4.5	JOGO DE JUNTAS INFERIOR COM RETENTORES	32
68310752	ISB6.7/QSB6.7	JOGO DE JUNTAS COMPLETO SEM RETENTORES	32
78310752	ISB6.7/QSB6.7	JOGO DE JUNTAS COMPLETO COM RETENTORES	34
68330751	ISB6.7/QSB6.7	JOGO DE JUNTAS SUPERIOR SEM RETENTORES	34
78330751	ISB6.7/QSB6.7	JOGO DE JUNTAS SUPERIOR COM RETENTORES	34
68330750	ISB6.7/QSB6.7	JOGO DE JUNTAS INFERIOR SEM RETENTORES	34
78330750	ISB6.7/QSB6.7	JOGO DE JUNTAS INFERIOR COM RETENTORES	34
78310732	ISF 4 CILINDROS.3.8L	JOGO DE JUNTAS COMPLETO COM RETENTORES	36
78330732	ISF 4 CILINDROS.3.8L	JOGO DE JUNTAS SUPERIOR COM RETENTORES	36
78330730	ISF 4 CILINDROS.3.8L	JOGO DE JUNTAS INFERIOR COM RETENTORES	36
78310712	ISF 4 CILINDROS.2.8L	JOGO DE JUNTAS COMPLETO COM RETENTORES	38
78330712	ISF 4 CILINDROS.2.8L	JOGO DE JUNTAS SUPERIOR COM RETENTORES	38
78330710	ISF 4 CILINDROS.2.8L	JOGO DE JUNTAS INFERIOR COM RETENTORES	38

/// ABBR

CUMMINS 4B/4BT 4 CILINDROS 3.9LITROS 8VÁLVULAS (EURO 2)

Nº JOGO		DESCRIÇÃO				
68313943		JOGO DE JUNTAS COMPLETO CUMMINS 4B / 4BT SEM RETENTORES	1			
78313943		JOGO DE JUNTAS COMPLETO CUMMINS 4B / 4BT COM RETENTORES	2			
68333941		JOGO DE JUNTAS SUPERIOR CUMMINS 4B / 4BT SEM RETENTORES	3			
78333941		JOGO DE JUNTAS SUPERIOR CUMMINS 4B / 4BT COM RETENTORES	4			
68333940		JOGO DE JUNTAS INFERIOR CUMMINS 4B / 4BT SEM RETENTORES	5			
78333940		JOGO DE JUNTAS INFERIOR CUMMINS 4B / 4BT COM RETENTORES	6			
Nº ABR	Nº CUMMINS	DESCRIÇÃO				
58312601	3283569	JUNTA DO CABEÇOTE Ø106MM	1	1	1	1
58311343	3902660	JUNTA DA TAMPA DE VÁLVULAS	4	4	4	4
58310431	3927154	JUNTA DO COLETOR DE ESCAPAMENTO	4	4	4	4
58313067	3938153	JUNTA DA TAMPA DO COLETOR DE ADMISSÃO	1	1	1	1
58312967	3938162	JUNTA DO CÁRTER	1	1	1	1
58309516	3914385	JUNTA DA TAMPA FRONTAL DE DISTRIBUIÇÃO	1	1	1	1
RE05287T	3909410	RETENTOR TRASEIRO DO VIRABREQUIM 130X150X14MM	1		1	
RE07647T	3904353	RETENTOR DIANTEIRO DO VIRABREQUIM 63,5X79,5X8MM	1		1	
RE09006S	3921640	RETENTOR DA HASTE DAS VÁLVULAS 7,5X12X12MM		8		8
56121231	3901356	JUNTA DA MESA DA TURBINA	1	1	1	1
58303790	3931350	JUNTA DO DRENO DE ÓLEO DA TURBINA	1	1	1	1
58303850	3908096	JUNTA DA TAMPA DA PLACA	1	1	1	1
58304616	3939258	JUNTA DA BOMBA DE COMBUSTÍVEL	1	1	1	1
58307016	3931348	JUNTA DA BOMBA				
58308066	3930120	BORRIFADOR DO BICO DO RESFRIADOR	4	4	4	4
58308390	3931607	JUNTA DA BOMBA INJETORA	1	1	1	1
58309616	3942914	JUNTA DO REFRIGERADOR DE ÓLEO	1	1	1	1
58309767	3938159	JUNTA DA TAMPA TRASEIRA	1	1	1	1
58309867	3938156	JUNTA DA CAIXA DE DISTRIBUIÇÃO	1	1	1	1
58310266	3930139	BORRIFADOR DA SAÍDA DO PISTÃO	4	4	4	4
58310616	154916	JUNTA DA BOMBA HIDRÁULICA	1	1	1	1
58310767	3938157	JUNTA DA BOMBA DO ÓLEO	1	1	1	1
58310816	3931349	JUNTA DA BOMBA DO ÓLEO	1	1	1	1
58310916	3008400	JUNTA DA BOMBA DE ÓLEO	1	1	1	1
58311632	3912220	JUNTA DA SAÍDA CONEXÃO EXAUSTÃO		1	1	1
58312432	3354864	JUNTA DA TURBINA	2	2	2	2
58314516	3929792	JUNTA DO CABEÇOTE DO FILTRO DE ÓLEO	1	1	1	1
58314640	3283767	JUNTA DA TAMPA LATERAL	1	1	1	1
58317416	3920336	JUNTA DA VÁLVULA TERMOSTÁTICA		1	1	1
58318467	3937604	JUNTA DO COLETOR DE ADMISSÃO	2	2	2	2
88310546		KIT DE BORRACHAS DO JOGO SUPERIOR	1	1	1	1
88310726		KIT DE ARRUELAS DO JOGO INFERIOR	1	1	1	1
88310746		KIT DE BORRACHAS DO JOGO INFERIOR	1	1	1	1
88319126		KIT DE ARRUELAS DO JOGO SUPERIOR	1	1	1	1

• VENDE-SE AVULSO

APLICAÇÃO

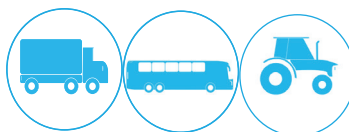

FORD CARGO 814 1996/01 815/815S 2001/05 F250/F350 1998/05 F4000 1996/05

CASE 580H 1994/...

FIAT-ALLIS RETRO FB80.4 / FB100.4

CUMMINS 4B/4BT 4 CILINDROS 3.9LITROS 8VÁLVULAS (EURO 2)

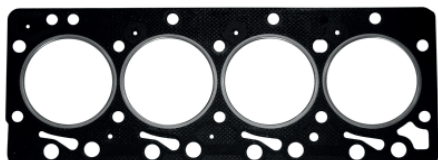

58312601 - DIÂMETRO 106 MM

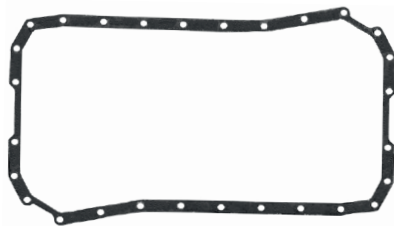

58312967

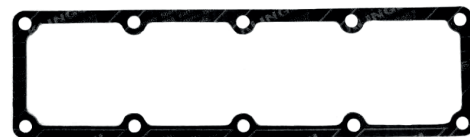

58313067



58314640

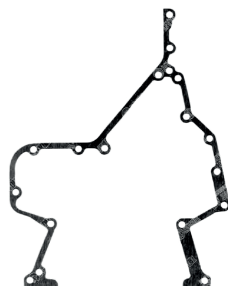

58309867

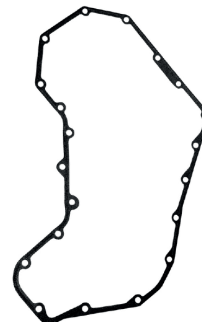

58309547



58311343



58318567



58310431

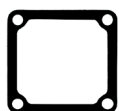

58318467



58317416



58308390

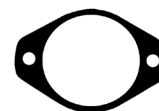

58310616



58310916



58310847



58310767



58309767



58314516



58309616



56121231



58303790



58308066



58304616



58312432



58311632



58303850



RE07647T



RE05287T



RE09006S



58307016



58310266

88310726 KIT DE ARRUELAS DO JOGO INFERIOR		
Nº ABR	DESCRIÇÃO	QTD
50072424	ARRUELA COBRE 22,5 X 26,7 X 1,50MM	2
50025124	ARRUELA COBRE 18,2X 23,5 X 1,5MM	4

88310546 KIT DE BORRACHA DO JOGO SUPERIOR		
Nº ABR	DESCRIÇÃO	QTD
58315240	ANEL BORRACHA 50,0X59,25X16,25MM	1
58315140	ANEL BORRACHA 9,75X19,0X8,6MM	4
50033541	VEDADOR 9,0 X 1,90MM	4
58311840	ANEL BORRACHA 48,0X30,0X3,0MM	1
58311940	ANEL BORRACHA 72,9X69,5X1,7MM	1

88310746 KIT DE BORRACHA DO JOGO INFERIOR		
Nº ABR	DESCRIÇÃO	QTD
50037341	ANEL 15,0X2,50MM	1
54355544	ANEL BORRACHA 74,0X85,0X9,8X10,2MM	1
58311140	ANEL BORRACHA 98,7X88,1X5,2MM	1
58307741	ANEL BORRACHA 29,7X33,8X2,0MM	1
58312140	ANEL BORRACHA 25,0X28,0X1,6MM	1
58311240	ANEL BORRACHA 60,7X50,1X5,2MM	1
58312240	ANEL BORRACHA 44,5X41,0X2,5MM	1
58316440	VEDADOR 122,6X119,3X2,6MM	1
	ANEL BORRACHA 157,10X163,10X7,1MM	1

88319126 KIT DE ARRUELAS DO JOGO SUPERIOR		
Nº ABR	DESCRIÇÃO	QTD
	ARRUELA AÇO 9,5 X 20,0 X 2,0MM	4
50072424	ARRUELA COBRE 22,5 X 27,2 X 1,50MM	2
50072429	ARRUELA ALUMÍNIO 22,5 X 26,7 X 1,5MM	1
58309224	ARRUELA COBRE 6,3X10X1,0MM (DUPLA)	4
50011024	ARRUELA COBRE 7,3X15,0X2,0MM	4
50011020	ARRUELA COBRE 7,3X15,0X1,0MM	4
	ARRUELA COBRE 9,6 X 16,0 X 1,5MM	4

CUMMINS ISBe4 3.9LITROS 16VÁLVULAS ELETRONICO (EURO 3)

Nº JOGO		DESCRIÇÃO		
78310643		JOGO DE JUNTAS COMPLETO CUMMINS ISBe4 COM RETENTORES	1	
78330641		JOGO DE JUNTAS SUPERIOR CUMMINS ISBe4 COM RETENTORES	2	
78330640		JOGO DE JUNTAS INFERIOR CUMMINS ISBe4 COM RETENTORES	3	
Nº ABR	Nº CUMMINS	DESCRIÇÃO		
58328902	2830706	JUNTA DO CABEÇOTE Ø107,5MM 1.25 MM	1	1
58328904	2830707	JUNTA DO CABEÇOTE Ø107,5MM 1.15 MM		
58329340	4899228	JUNTA DA TAMPA DAS VÁLVULAS	1	1
58325431	3955339	JUNTA DO COLETOR DE ESCAPAMENTO	4	4
58327940	4897877	JUNTA DO CÂRTER	1	1
RE08428T	4890833	RETENTOR TRASEIRO DO VIRABREQUIM 130X155X14MM	1	1
RE08427T	4890832	RETENTOR DIANTEIRO DO VIRABREQUIM 70X100X12,5/16MM	1	1
RE08429V	3955393	RETENTOR DA HASTE DAS VÁLVULAS 6,25X12,6X14MM	16	16
50951490	36832135	JUNTA DO TUBO DA LUBRIFICAÇÃO	1	1
58328030	4898301	JUNTA DA CONEXÃO DA SUÇÇÃO DE ÓLEO	1	1
58328130	4890024	BORRIFADOR DO BICO DO RESFRIADOR	4	4
58328247	4895742	JUNTA DO RESFRIADOR DE ÓLEO	1	1
58328347	4896409	JUNTA DO FILTRO DO ÓLEO	1	1
58328431	4896897	JUNTA DA BOMBA HIDRÁULICA	1	1
58328832	3919369	JUNTA DO TURBO COMPRESSOR	1	1
58329132	3932475	JUNTA DA MESA DA TURBINA	1	1
58329440	4899230	JUNTA DA TAMPA DOS BALANCINS	1	1
88321346		KIT DE BORRACHAS DO JOGO INFERIOR	1	1
88321446		KIT DE BORRACHAS DO JOGO SUPERIOR	1	1
88321726		KIT DE ARRUELAS DO JOGO SUPERIOR	1	1

● VENDE-SE AVULSO

APLICAÇÃO

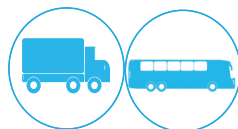

AGRALE MA 12.0 2006/12
FORD 712E 2007/12 F350/815E/1317E/1517E/1717E/1722E/2422E/2622E 2005/2012 F4000 2005/12 F4 MILHA 2009/12 F250 2006/12
VOLKSWAGEN 8150/13170/15170 2003/06 DELIVERY 8150 PLUS/9150 2005/12 9150 2007/...

CUMMINS ISBe4 3.9LITROS 16VÁLVULAS ELETRONICO (EURO 3)



58328902 - ESPESSURA 1,25 MM

58328904 - ESPESSURA 1,15 MM



58327940



58329340



58329440



58328130



58328030



58325431



50951490



58328467



58328832



58329132



RE08427T



RE08428T



58328347



58328247



RE08429V

88321346 KIT DE BORRACHA DO JOGO INFERIOR		
Nº ABR	DESCRIÇÃO	QTD
	VEDADOR 12,30 X 2,40MM	1
	VEDADOR 56,74 X 3,50MM	1
	VEDADOR 62,00 X 1,50MM	1
	VEDADOR 24,00 X 2,50MM	1
	VEDADOR 21,89 X 2,65MM	1
	VEDADOR 20,35 X 1,78MM	1
	VEDADOR 30,00 X 2,50MM	1
	VEDADOR 29,74 X 3,50MM	1
	VEDADOR 14,00 X 2,50MM	1
	VEDADOR 25,50 X 2,50MM	1

88321446 KIT DE BORRACHA DO JOGO SUPERIOR		
Nº ABR	DESCRIÇÃO	QTD
	VEDADOR 13,30 X 2,40MM	2
	VEDADOR 17,00 X 3,00MM	2
	VEDADOR 85,00 X 2,50MM	1
	VEDADOR 11,50 X 3,00MM	6
	VEDADOR 54,00 X 4,00MM	1
	VEDADOR 88,27 X 98,6 X 5,20MM	1
	VEDADOR 105,00 X 111,60 X 3,50MM	1
	VEDADOR 21,00 X 2,50MM	1
	VEDADOR 14,10 X 20,10 X 3,00MM	2
	VEDADOR 15,50 X 18,20 X 2,80MM	1
	VEDADOR 8,00 X 2,40MM	12
	VEDADOR 9,80 X 1,90MM	2
	VEDADOR 21,30 X 3,00MM	6
	VEDADOR 25,00 X 2,50MM	3

88321726 KIT DE ARRUELAS DO JOGO SUPERIOR		
Nº ABR	DESCRIÇÃO	QTD
	ARRUELA ALUMÍNIO 12 X 18 X 1,50MM	2
	ARRUELA ALUMÍNIO 14 X 24 X 1,50MM	2
	ARRUELA COBRE 12 X 16 X 1,50MM	2

CUMMINS 6B/6BT 6 CILINDROS 5.9LITROS 12VÁLVULAS (EURO 2)

Nº JOGO	DESCRIÇÃO
68315943	JOGO DE JUNTAS COMPLETO CUMMINS 6B/6BT SEM RETENTORES
78315943	JOGO DE JUNTAS COMPLETO CUMMINS 6B/6BT COM RETENTORES
68335941	JOGO DE JUNTAS SUPERIOR CUMMINS 6B/6BT SEM RETENTORES
78335941	JOGO DE JUNTAS SUPERIOR CUMMINS 6B/6BT COM RETENTORES
68335940	JOGO DE JUNTAS INFERIOR CUMMINS 6B/6BT SEM RETENTORES
78335940	JOGO DE JUNTAS INFERIOR CUMMINS 6B/6BT COM RETENTORES

Nº ABR	Nº CUMMINS	DESCRIÇÃO	6	5	4	3	2	1
58310501	3283570	JUNTA DO CABEÇOTE Ø106MM				1	1	1
58311343	3902666	JUNTA DA TAMPA DAS VÁLVULAS				6	6	6
58310431	3927154	JUNTA DO COLETOR DE ESCAPAMENTO				6	6	6
58310067	3931347	JUNTA DO COLETOR DE ADMISSÃO				1	1	1
58307290	3931346	JUNTA DO CÁRTER	1	1				1
58309416	3918673	JUNTA DA TAMPA FRONTAL DE DISTRIBUIÇÃO C/ BOMBA INJETORA ROTATIVA	1	1				1
58309516	3914385	JUNTA DA TAMPA FRONTAL DE DISTRIBUIÇÃO	1	1				1
RE05287T	3909410	RETENTOR TRASEIRO DO VIRABREQUIM 130X150X14MM	1					1
RE07647T	3904353	RETENTOR DIANTEIRO DO VIRABREQUIM 63,5X79,5X8MM	1					1
RE09006S	3921640	RETENTOR DA HASTE DAS VÁLVULAS 7,5X12X12MM				12		12
56121231	3901356	JUNTA DA MESA DA TURBINA				1	1	1
58303790	3931350	JUNTA DO DRENO DE ÓLEO DA TURBINA				1	1	1
58303850	3908096	JUNTA DA TAMPA	1	1				1
58304616	3939258	JUNTA DA BOMBA DE COMBUSTÍVEL	1	1				1
58307016	3931348	JUNTA DA TAMPA DA BOMBA DE TRANSFERÊNCIA	1	1				1
58308066	3901020	JUNTA DO BICO DO RESFRIADOR	6	6				6
58308390	3931607	JUNTA DA BOMBA INJETORA	1	1				1
58309616	3942914	JUNTA DO REFRIGERADOR DE ÓLEO	1	1				1
58309767	3928493	JUNTA DA TAMPA TRASEIRA	1	1				1
58309867	3916131	JUNTA DA CAIXA DE DISTRIBUIÇÃO	1	1				1
58310266	3930139	BORRIFADOR DA SAÍDA DO PISTÃO	6	6				6
58310616	154916	JUNTA DA BOMBA HIDRÁULICA	1	1				1
58310767	3914383	JUNTA DA BOMBA DO ÓLEO	1	1				1
58310847	3931349	JUNTA DA BOMBA DO ÓLEO	1	1				1
58310916	3008400	JUNTA DO COMPRESSOR	1	1				1
58311016	3942915	JUNTA DO FILTRO	1	1				1
58311632	3912220	JUNTA DA SAÍDA CONEXÃO EXAUSTÃO				1	1	1
58312432	3354864	JUNTA DA TURBINA				2	2	2
58314516	3929792	JUNTA DO FILTRO DO ÓLEO	1	1				1
58315040	3928832	JUNTA DA TAMPA LATERAL	1	1				1
58317447	3920336	JUNTA DA VÁLVULA TERMOSTÁTICA				1	1	1
58318467	3931604	JUNTA DO COLETOR DE ADMISSÃO				1	1	2
58318567		JUNTA DO DRENO DE ÓLEO DA TURBINA				1	1	1
88310846		KIT DE BORRACHAS DO JOGO SUPERIOR				1	1	1
88310946		KIT DE BORRACHAS DO JOGO INFERIOR	1	1				1
88319226		KIT DE ARRUELAS DO JOGO SUPERIOR				1	1	1
88310926		KIT DE ARRUELAS DO JOGO INFERIOR	1	1				1

● VENDE-SE AVULSO

APLICAÇÃO

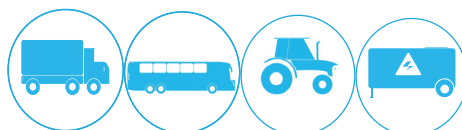

VOLKSWAGEN 12170BT/14170BT 1997/00 16200 1997/03 13170/15170 2000/02 17170 2000/03
13190/15190/15210/23210 2002/05 16170BT 1994/99 16200 1998/00 17210 2000/06
FORD C-1215 1992/01 C-1217 2001/02 C-1415 1992/00 C-1417 2001/02 C-1421 2000/02 C-1517
1992/05 C-1521 2003/06 C-1617 2000/02 C-1621 2000/02 C-1717 2003/05 C-2421 2004/05 F12000 1992/05 F16000 1999/04
CUMMINS C90 D5 / C110 D5 / C150 D5 / C170 D5. CASE IH2188 1998/...A4000 2006/... CASE MAXXUM 135/150 2002/06
VALMET / VALTRA 1180 1991/95 FIAT-ALLIS TRATOR FD130/FW140/FG140B/FX215C

CUMMINS 6B/6BT 6 CILINDROS 5.9LITROS 12VÁLVULAS (EURO 2)



58310501 - DIÂMETRO 106 MM

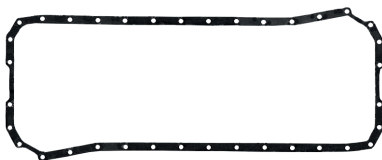

58307290



58310067



58315040

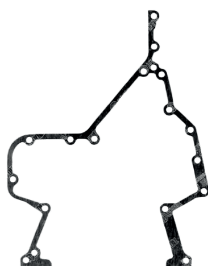

58309867



58311343

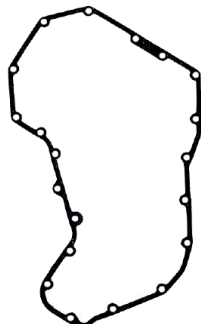

58309447

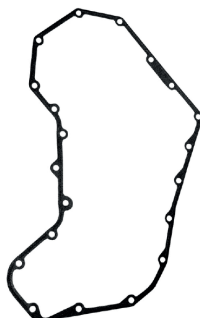

58309547



58309767



58316730



58318467



58311632



58317447



58303850



58308390



58310767



58310816



58303790



58310431



58304616



58310916



58310616



RE05287T



RE07647T



58309647



58311047



58314516



58307016



58312432



58310266



58308066



RE090065

88310846 KIT DE BORRACHAS DO JOGO SUPERIOR		
Nº ABR	DESCRIÇÃO	QTD
58315240	ANEL BORRACHA 50,0X59,25X16,25MM	1
58315140	ANEL BORRACHA 9,75 X 19,0 X 8,6 MM	6
50033541	VEDADOR 9,0 X 1,90MM	6
58311840	ANEL BORRACHA 48,0 X 30,0 X 3,0 MM	1
58311940	ANEL BORRACHA 72,9 X 69,5 X 1,7 MM	1

88319226 KIT DE ARRUELAS DO JOGO SUPERIOR		
Nº ABR	DESCRIÇÃO	QTD
	ARRUELA COBRE 22,5 X 27,0 X 1,50MM	1
	ARRUELA ALUMÍNIO 22,5 X 27,0 X 1,5MM	1
58309224	ARRUELA COBRE 6,3X10X1,0MM (DUPLA)	6
50011024	ARRUELA COBRE 7,3 X 15,0 X 2,0 MM	6
50011020	ARRUELA COBRE 7,3 X 15,0 X 1,0 MM	6
50014424	ARRUELA COBRE 9,6 X 15,3 X 1,5 MM	6
	ARRUELA AÇO 9,5 X 20,0 X 2,0 MM	6

88310946 KIT DE BORRACHAS DO JOGO INFERIOR		
Nº ABR	DESCRIÇÃO	QTD
50037341	ANEL 15,0X2,50MM	1
54355544	ANEL BORRACHA 74,0X85,0X9,8/10,2MM	1
58311140	ANEL BORRACHA 98,7X88,1X5,2MM	1
58307741	ANEL BORRACHA 29,7X33,8X2,0MM	1
58312140	ANEL BORRACHA 25,0X28,0X1,6MM	1
58311240	ANEL BORRACHA 60,7X50,1X5,2MM	1
58312240	ANEL BORRACHA 44,5X41,0X2,5MM	1

88310926 KIT DE ARRUELAS DO JOGO INFERIOR		
Nº ABR	DESCRIÇÃO	QTD
50072424	ARRUELA COBRE 22,5 X 26,7 X 1,50MM	2
	ARRUELA COBRE 18,2 X 24,0 X 1,5MM	1

CUMMINS ISBe6 5.9LITROS 24VÁLVULAS ELETRONIC (EURO 3)

Nº JOGO		DESCRIÇÃO					
68310663		JOGO DE JUNTAS COMPLETO CUMMINS ISBe6 5.9L 24V SEM RETENTORES	1				
78310663		JOGO DE JUNTAS COMPLETO CUMMINS ISBe6 5.9L 24V COM RETENTORES	2				
68330661		JOGO DE JUNTAS SUPERIOR CUMMINS ISBe6 5.9L 24V SEM RETENTORES	3				
78330661		JOGO DE JUNTAS SUPERIOR CUMMINS ISBe6 5.9L 24V COM RETENTORES	4				
68330660		JOGO DE JUNTAS INFERIOR CUMMINS ISBe6 5.9L 24V SEM RETENTORES	5				
78330660		JOGO DE JUNTAS INFERIOR CUMMINS ISBe6 5.9L 24V COM RETENTORES	6				
Nº ABR	Nº CUMMINS	DESCRIÇÃO					
58329002-	2830704	JUNTA DO CABEÇOTE Ø107MM – 1,25MM		1	1	1	1
58329004-	2830705	JUNTA DO CABEÇOTE Ø107MM – 1,15MM					
58328740-	4899231	JUNTA DA TAMPA DAS VÁLVULAS		1	1	1	1
58325431-	3955339	JUNTA DO COLETOR DE ESCAPAMENTO		6	6	6	6
58328540-	4897861	JUNTA DO CÂRTER	1	1		1	1
RE08428T-	4890833	RETENTOR TRASEIRO DO VIRABREQUIM 130X155X14MM	1			1	
RE08427T-	4890832	RETENTOR DIANTEIRO DO VIRABREQUIM 70X100X12,5/16MM	1			1	
RE08429V-	3955393	RETENTOR DA HASTE DAS VÁLVULAS 6,25X12,6X14MM		24		24	
50951490	36832135	JUNTA DO DRENO DE ÓLEO DA TURBINA		1	1	1	1
58328030	4898301	JUNTA DA CONEXÃO DA SUÇÃO DE ÓLEO	1	1		1	1
58328130	4890024	BORRIFADOR DO BICO DO RESFRIADOR	6	6		6	6
58328231-	4895742	JUNTA DO RESFRIADOR DE ÓLEO	1	1		1	1
58328347-	4896409	JUNTA DO FILTRO DO ÓLEO	1	1		1	1
58328431-	48 96897	JUNTA DA BOMBA HIDRÁULICA	1	1		1	1
58328640-	4899226	JUNTA DA TAMPA DOS BALANCINS INFERIOR		1	1	1	1
58328832-	3919369	JUNTA DA MESA DA TURBINA		1	1	1	1
58329132-	3932475	JUNTA DA MESA DA TURBINA		1	1	1	1
88321346		KIT DE BORRACHAS DO JOGO INFERIOR	1	1		1	1
88321446		KIT DE BORRACHAS DO JOGO SUPERIOR		1	1	1	1
88321726		KIT DE ARRUELAS DO JOGO SUPERIOR		1	1	1	1

• VENDE-SE AVULSO

APLICAÇÃO

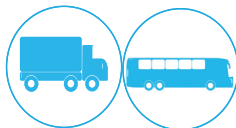

VOLKSWAGEN 17250/23250 2003/...CONSTELLATION 17250/24250/2006/...17250 2007/...

FORD 2428E/2628E 2006/12

AGRALE MT 12.0 LE 2006/12 ; MT 12.0 SB 2004/12

CUMMINS ISBe6 5.9LITROS 24VÁLVULAS ELETRONIC (EURO 3)



58329002 - ESPESSURA 1,25 MM

58329004 - ESPESSURA 1,15 MM



58328540



58328640



58328740



58328130



58328030



58325431



50951490



58328431



58355432



58329132



RE08427T



RE08428T



58328347



58328231



RE08429V

88321346 KIT DE BORRACHAS DO JOGO INFERIOR		
Nº ABR	DESCRIÇÃO	QTD
	VEDADOR 12,30 X 2,40MM	12
	VEDADOR 56,74 X 3,50MM	1
	VEDADOR 62,00 X 1,50MM	1
	VEDADOR 24,00 X 2,50MM	1
	VEDADOR 21,89 X 2,65MM	1
	VEDADOR 20,35 X 1,78MM	1
	VEDADOR 30,00 X 2,50MM	1
	VEDADOR 29,74 X 3,50MM	1
	VEDADOR 14,00 X 2,50MM	1
	VEDADOR 25,50 X 2,50MM	1
	VEDADOR 11,00 X 1,50MM	1
	VEDADOR 23,50 X 2,62MM	2
	VEDADOR 50,00 X 3,00MM	1

88321446 KIT DE ARRUELAS DO JOGO SUPERIOR		
Nº ABR	DESCRIÇÃO	QTD
	VEDADOR 13,30 X 2,40MM	2
	VEDADOR 17,00 X 3,00MM	2
	VEDADOR 85,00 X 2,50MM	1
	VEDADOR 11,50 X 3,00MM	6
	VEDADOR 54,00 X 4,00MM	1
	VEDADOR 88,27 X 98,6 X 5,20MM	1
	VEDADOR 105,00 X 111,60 X 3,50MM	1
	VEDADOR 21,00 X 2,50MM	1
	VEDADOR 14,10 X 20,10 X 3,00MM	2
	VEDADOR 15,50 X 18,20 X 2,80MM	1
	VEDADOR 8,00 X 2,40 MM	12
	VEDADOR 9,80 X 1,90 MM	2
	VEDADOR 21,30 X 3,00MM	6
	VEDADOR 25,00 X 2,50MM	3

88321726 KIT DE ARRUELAS DO JOGO SUPERIOR		
Nº ABR	DESCRIÇÃO	QTD
	ARRUELA ALUMÍNIO 12 X 18 X 1,50MM	2
	ARRUELA ALUMÍNIO 14 X 24 X 1,50MM	2
	ARRUELA COBRE 12 X 16 X 1,50MM	2

CUMMINS 6C/6CTA 6 CILINDROS 8.3LITROS 12VÁLVULAS (EURO 2)

Nº JOGO	DESCRIÇÃO
68314943	JOGO DE JUNTAS COMPLETO CUMMINS 6C/6CTA SEM RETENTORES
78314943	JOGO DE JUNTAS COMPLETO CUMMINS 6C/6CTA COM RETENTORES
68334941	JOGO DE JUNTAS SUPERIOR CUMMINS 6C/6CTA SEM RETENTORES
78334941	JOGO DE JUNTAS SUPERIOR CUMMINS 6C/6CTA COM RETENTORES
68334940	JOGO DE JUNTAS INFERIOR CUMMINS 6C/6CTA SEM RETENTORES
78334940	JOGO DE JUNTAS INFERIOR CUMMINS 6C/6CTA COM RETENTORES
78314949	JOGO DE JUNTAS COMPLETO CUMMINS 6C/6CTA COM RETENTORES COM ANÉIS DE CAMISA
78334949	JOGO DE JUNTAS INFERIOR CUMMINS 6C/6CTA COM RETENTORES COM ANÉIS DE CAMISA

Nº ABR	Nº CUMMINS	Nº VW	DESCRIÇÃO						
58308101	3935585	2SO103383A	JUNTA DO CABEÇOTE EM HTM-S Ø123,5MM – 1,65MM	1		1	1	1	1
58308102	3935586	2RK103383D	JUNTA DO CABEÇOTE EM HTM-S Ø123,5MM – 1,90MM						
58308104	3935587	2RK103383E	JUNTA DO CABEÇOTE EM HTM-S Ø123,5MM – 2,15MM						
58307443	3905449	TE310483	JUNTA DA TAMPA DAS VÁLVULAS	1		1	1	1	1
58303630	3929012	2RK129589	JUNTA DO COLETOR DO ESCAPAMENTO EM AÇO	6		6	6	6	6
58303098	3914311	2SO129717	JUNTA DO COLETOR DE ADMISSÃO	1		1	1	1	1
58305798	3934044	2TO103609	JUNTA DO CÂRTER	1	1	1	1		1
58304216	3917780	2RL109289	JUNTA DA TAMPA FRONTAL (VEICULAR)	1	1	1	1		1
58304398	3929253	TJG109235	JUNTA DA CAIXA DE DISTRIBUIÇÃO	1	1	1	1		1
RE05287T	3909410	2SO103085A	RETENTOR VIRABREQUIM TRASEIRO	1	1	1			1
RE05536T	3353977	2RK109215	RETENTOR VIRABREQUIM DIANTEIRO	1	1	1			1
RE09005S	3915707 / 3919038	2RK109675	RETENTOR DA HASTE DAS VÁLVULAS (COM SUPORTE DE METAL)	12		12			12
50950890	3931350		JUNTA DO RETORNO DO ÓLEO DO TURBO	1		1	1	1	1
58303198	3914301	TJG103037	JUNTA DA TAMPA TRASEIRA	1	1	1	1		1
58303290	3916042	2TO145818A	JUNTA DO COMPRESSOR	1	1	1	1		1
58303316	3918174	TJG115441	JUNTA DO FILTRO DE ÓLEO	1	1	1	1		1
58303790	3901805	2SO145757	JUNTA DO TUBO DO DRENO DE ÓLEO	1		1	1	1	1
58303998	3914302	TJG115259	JUNTA DO CANO DO RESPIRO DE ÓLEO	1	1	1	1		1
58304016	3914308	2RK115441	JUNTA DO FILTRO DE ÓLEO (ANTIGO)	1	1	1	1		1
58304616	3939258	2TD130123A	JUNTA DA BOMBA DE COMBUSTÍVEL	1	1	1	1		1
58306331	3352494	TE3253135A	JUNTA DE VEDAÇÃO DO ESCAPAMENTO	2		2	2	2	2
58306490	3914310	TJG121119	JUNTA DO TERMOSTATO	1		1	1	1	1
58306590	3917892	TF3145647	JUNTA DO ADAPTADOR DA BOMBA	1		1	1	1	1
58306790	3060912	2RK121809	JUNTA DA CONEXÃO	1		1	1	1	1
58307016	3931348	TAF130123	JUNTA DA TAMPA DA BOMBA DE TRANSFERÊNCIA	1	1	1	1		1
58307390	3921440	TJG129719	JUNTA DA CONEXÃO DE ADMISSÃO	1		1	1	1	1
58307536	3911941	TF3145453	JUNTA DA SAÍDA DO ESCAPAMENTO	1		1	1	1	1
58307966	3905928	TJG113117	BORRIFADOR DA SAIA DO PISTÃO (ATÉ 1990)	6	6	6	6		6
58308390	3931607	2SO130119	JUNTA DA BOMBA INJETORA	1	1	1	1		1
58308490	176027	2RL145617A	JUNTA DO SUPORTE DO COMPRESSOR DE AR	1	1	1	1		1
58308531	3575909	TRA145453	JUNTA DA TURBINA	1		1	1	1	1
58310116	3929011	2RK115441A	JUNTA DO FILTRO DE ÓLEO (MODERNO)	1	1	1	1		1
58310266	3930139	TJG103117	BORRIFADOR DA SAIA DO PISTÃO (APÓS 1990)	12	12	12	12		12
58310341	3912473	TF3103221	ANEL DE BORRACHA	1	1	1	1		1
58314445	3907177	TE3107125	ANEL DE CAMISA	6	6				
58316267	3354398	TLG129717	JUNTA DE ADMISSÃO INTERMEDIÁRIA	1	1		1	1	1
58316367	TJG103609	TJG103609	JUNTA	1	1	1			1
58317830	3914708	TJG129789	TRAVA DO ESCAPAMENTO	12		12	12	12	12
88310146			KIT DE BORRACHAS DO JOGO SUPERIOR	1	1		1	1	1
88310126			KIT DE ARRUELAS DO JOGO SUPERIOR	1	1		1	1	1
88310246			KIT DE BORRACHAS DO JOGO INFERIOR	1	1	1	1		1
88310226			KIT DE BORRACHAS DO JOGO INFERIOR	1	1	1	1		1

● VENDE-SE AVULSO

APLICAÇÃO

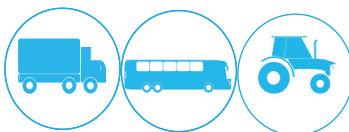

VOLKSWAGEN 14210 1988/91 ; 16210/16210H 1989/91 ; 16170 1988/93 ; 16220 1990/00 ; 24220 1990/01 ; 35300 1991/99 ;
 14220 1991/98 ; 40300 1999/01 ; 17300 2000/02 ; 23310/26310/26220/26260 2002/04 ; 17310/18310 2002/06 ; 23220 2002/06 ;
 24250 1992/01 ; 16300 1996/00 ; 17220 2000/12 ; 26300 2001/01 ; 22210 1988/88 ; 24220 2006/12 ;
 VW 17210 OD 2001/...18310 OT 2003/...

FORD CAMINHÃO C-1422 1991/00 ; C-1617 1992/99 ; C-1622 1991/02 ; C-1722 1999/02 ; C-2322 1991/96 ; C-2422 1993/05 ;
 C-3621/22 1994/01 ; C-1731/C-3222 2003/05 ; C-2324/C-3224 1992/97 ; C-2425 1996/02 ; C-2622 2002/05 ; C-2626 2002/06 ;
 C-2630 1998/02 ; C-2831 2005/05 ; C-3530 1991/97 ; C-4030 1994/02 ; C-4031 2002/05 ; C-4331 2003/06 ; C-5031 2005/05 ;
 C-1630 2001/02 ; C-1721 2002/05 ; C-1722 2002/05 ; C-2631 2002/05 ;

FORD COLHEITADEIRA CS660 2004/16 ; CS6090 2015/...TC5090 2008/16 ;

CASE COLHEITADEIRA IH2155 1998/...AF2166 1996/99 ; AF2366 1998/03 ; AF2388 1998/10 ; AF2399 2006/10 ; AF2566 2011/15 ;
 AF2688/2799 2010/15 ; A7000/A7700 2001/08 ;

MASSEY FERGUSON COLHEITADEIRA MF34 1998/11 ; MF38 1998/06 ; FIAT TRACTOR FD170 1995/05

CASE TRATOR MAXXUM 165/180 ; MAGNUM 240/270 2002/06 ; 220 2002/...305 2009/...8920/8940 1992/...

CUMMINS 6C/6CTA 6 CILINDROS 8.3LITROS 12VÁLVULAS (EURO 2)



58308101 - ESPESSURA 1,65 MM

58308102 - ESPESSURA 1,90 MM

58308104 - ESPESSURA 2,15 MM



58305798



58307443



58303098

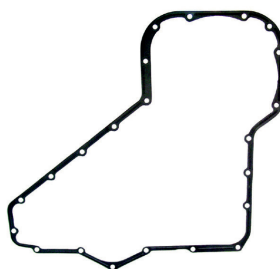

58304216

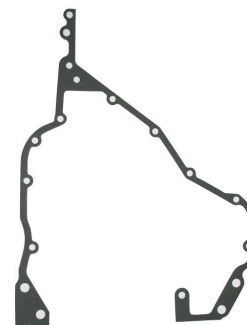

58304398



58307390



58316267

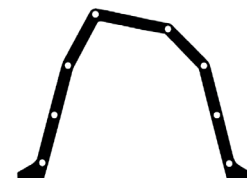

58303198



58303316

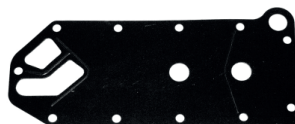

58304016



58310116



58306790



58303630



58304616



58303290



58317830



58303790

CUMMINS 6C/6CTA 6 CILINDROS 8.3LITROS 12VÁLVULAS (EURO 2)



58303998



50950890

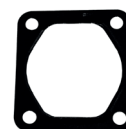

58307536



58316367



58308390

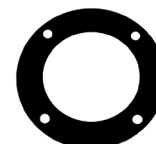

58306590



58306331



RE05536T



RE05287T



58308531



58306490



RE09005S



58307016



58308490



58310266



58307966

88310246 KIT DE BORRACHAS DO JOGO INFERIOR		
Nº ABR	DESCRIÇÃO	QTD
50007841	VEDADOR 27,0 X 3,3MM	1
58307741	VEDADOR 29,7X33,8X2,0MM	1
58307641	VEDADOR 39X59,8X2,0MM	1
50046541	VEDADOR 101,3 X 3,0MM	1
50026941	VEDADOR 75,0 X 3,0MM	1
50046041	VEDADOR 102,0X2,0MM	1
50010841	VEDADOR 25,5 X 2,8MM	1
50037341	VEDADOR 15,0X2,50MM	1
54386740	VEDADOR 12,5X2,6MM	1
58310341	VEDADOR 157,00X163,1X7,0MM	1

88310226 KIT DE ARRUELAS DO JOGO INFERIOR		
Nº ABR	DESCRIÇÃO	QTD
50028724	ARRUELA COBRE 22,3 X 27,9 X 1,50MM	1
50030720	ARRUELA COBRE 26,3 X 30,9 X 2,00MM	1
50025124	ARRUELA COBRE 18,2 X 23,5 X 1,50MM	1

88310126 KIT DE ARRUELAS DO JOGO SUPERIOR		
Nº ABR	DESCRIÇÃO	QTD
50951720	ARRUELA COBRE 7,3X15,3X1,98/2,08MM	6
58309224	ARRUELA COBRE 6,3X10X1,0MM (DUPLA)	7
	ARRUELA COBRE 22,3 X 28,2 X 1,50MM	2
50070729	ARRUELA ALUMÍNIO 12,7 X 17,8 X 1,5MM	4
50084029	ARRUELA ALUMÍNIO 14,6 X 20,8 X 1,5MM	2

88310146 KIT DE BORRACHAS DO JOGO SUPERIOR		
Nº ABR	DESCRIÇÃO	QTD
50004341	VEDADOR 14,0X19,0X3,2MM	1
50040041	VEDADOR 18,0 X 2,50MM	1
50033541	VEDADOR 9,0 X 1,90MM	6
50046141	VEDADOR 68,1X 2,0MM	1

Nº JOGO		DESCRIÇÃO				
68310593		JOGO DE JUNTAS COMPLETO CUMMINS ISC 8.3L/ ISL 8.9L SEM RETENTORES				1
78310593		JOGO DE JUNTAS COMPLETO CUMMINS ISC 8.3L/ ISL 8.9L COM RETENTORES				2
68330591		JOGO DE JUNTAS SUPERIOR CUMMINS ISC 8.3L/ ISL 8.9L SEM RETENTORES				3
78330591		JOGO DE JUNTAS SUPERIOR CUMMINS ISC 8.3L/ ISL 8.9L COM RETENTORES				4
68330590		JOGO DE JUNTAS INFERIOR CUMMINS ISC 8.3L/ ISL 8.9L SEM RETENTORES				5
78330590		JOGO DE JUNTAS INFERIOR CUMMINS ISC 8.3L/ ISL 8.9L COM RETENTORES				6
Nº ABR	Nº CUMMINS	DESCRIÇÃO				
58325701	3967059	JUNTA DO CABEÇOTE Ø123,5MM -1,70MM			1	1
58327140	3959798	JUNTA DA TAMPA DAS VÁLVULAS			1	1
58325531	3937479	JUNTA DO COLETOR DE ESCAPAMENTO			6	6
58329667	3944646	JUNTA DO COLETOR DE ADMISSÃO			1	1
58305767	3938160	JUNTA DO CÂRTER	1	1		1
58303198	3939353	JUNTA DA TAMPA TRASEIRA	1	1		1
58327447	3944293	JUNTA DA CARÇAÇA DAS ENGRENAGENS	1	1		1
RE05287T	3909410	RETENTOR TRASEIRO DO VIRABREQUIM	1			1
RE05536T	3353977	RETENTOR DIANTEIRO DO VIRABREQUIM	1			1
RE08432V	3943888	RETENTOR DA HASTE DAS VÁLVULAS			24	24
56121231	3901356	JUNTA DA MESA DA TURBINA			1	1
58303347	3918174	JUNTA DO RESFRIADOR DE ÓLEO	1	1		1
58303790	3937706	JUNTA DO DRENO DE ÓLEO DA TURBINA			1	1
58303998	3914302	JUNTA DO CANO DO RESPIRO DE ÓLEO	1	1		1
58310116	3929011	JUNTA DO FILTRO DE ÓLEO	1	1		1
58327067	3967891	JUNTA DA CONEXÃO DO TUBO DE ADMISSÃO			1	1
58327340	3966708	JUNTA DA TAMPA DOS BALANCINS			1	1
58327567	3940245	JUNTA DO RESFRIADOR DE ÓLEO	1	1		1
58327647	3945603	JUNTA DA CONEXÃO DA ENTRADA D'ÁGUA	1	1		1
58327730	4902952	JUNTA DA BOMBA DE COMBUSTÍVEL	1	1		1
58327830	3755843	JUNTA DA MESA DA TURBINA			1	1
58329767	3992090	JUNTA DA CONEXÃO DE ADMISSÃO			1	1
88321546		KIT DE BORRACHAS DO JOGO SUPERIOR			1	1
88321646		KIT DE BORRACHAS DO JOGO INFERIOR	1	1		1
88321826		KIT DE ARRUELAS DO JOGO SUPERIOR			1	1
88321926		KIT DE ARRUELAS DO JOGO INFERIOR	1	1		1

● VENDE-SE AVULSO

APLICAÇÃO

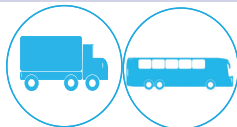

VOLKSWAGEN CAMINHÃO ISC 31310 2005/...19320 2006/...25320 2008/...31320 2007/...VW ÔNIBUS ISC 18320 EOT 2006/12
VOLKSWAGEN CAMINHÃO ISL 24330/19420/25420/26420 2013/...19330/30330/19360 2015/...17330/19390/25360/25390/26390 2017/...
VOLKSWAGEN ÔNIBUS ISL 18330 OT 2018/...
FORD TRUCK ISC C-2831E/C4331E/C-5031E 2005/06 ; C-1932E/C-3132E 2011/12 ; C-4432E 2006/07 ; C-4532E 2007/11 ;
C-6632E 2008/11 ; C-2632E/C-2932E/C-5032E 2006/08 ; C-1832E 2010/11 ; FORD TRUCK ISL 1933E 2014/2018 ; 3133E 2012/...

CUMMINS ISC 8.3LITROS 24VÁLVULAS ELETRÔNICO(EURO 3)/ISL 8.9LITROS 24VÁLVULAS ELETRÔNICO(EURO 5)

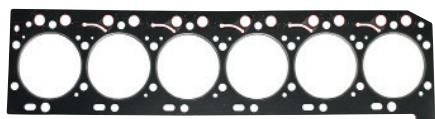

58325701 - ESPESSURA 1,70 MM



58305767



58329667



58327340



58327140



58329767



58327447

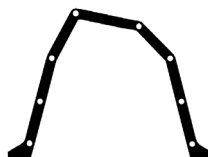

58303198



58327730



58303790



58303998



58325531



58327830



RE05287T



RE05536T



58121231



58327067



58327647



58327567



58303347



58310116



RE08432V

88321546 KIT DE BORRACHAS DO JOGO SUPERIOR		
Nº ABR	DESCRIÇÃO	QTD
	VEDADOR 11,50 X 2,70MM	6
	VEDADOR 11,20 X 2,50MM	3
	VEDADOR 9,50X 2,00MM	2
	VEDADOR 8,00 X 1,70 MM	1
	VEDADOR 15,60 X 2,30MM	1
	VEDADOR 16,50 X 2,62MM	2
	VEDADOR 85,00 X 2,50MM	1
	VEDADOR 61,66 X 2,62MM	1
	VEDADOR 19,00 X 1,50MM	1
	VEDADOR 48,50 X 3,00MM	1
	VEDADOR 30,00 X 2,50MM	1
	VEDADOR 25,00 X 2,60MM	2
	VEDADOR 21,00 X 3,00MM	6

88321646 KIT DE BORRACHAS DO JOGO INFERIOR		
Nº ABR	DESCRIÇÃO	QTD
	VEDADOR 21,82 X 3,50MM	1
	VEDADOR 66,40 X 1,78MM	2
	VEDADOR 25,00 X 2,60MM	1
	VEDADOR 110,72 X 3,53MM	1
	VEDADOR 8,00 X 1,50MM	1
	VEDADOR 7,50 X 2,50MM	2
	VEDADOR 9,25 X 1,78MM	1
	VEDADOR 11,30 X 2,00MM	4
	VEDADOR 15,50 X 2,00MM	1
	VEDADOR 19,25 X 2,20MM	3
	VEDADOR 18,72 X 2,62MM	1
	VEDADOR 20,35 X 1,78MM	1
	VEDADOR 62,00 X 2,50MM	1
	VEDADOR 152,85X158,85X7,0MM	1

88321826 KIT DE ARRUELAS DO JOGO SUPERIOR		
Nº ABR	DESCRIÇÃO	QTD
	ARRUELA COBRE 8 X 15 X 1,50MM	6
	ARRUELA COBRE 18 X 24 X 1,50MM	1
	ARRUELA ALUMÍNIO 14 X 24 X 1,50MM	1
	ARRUELA ALUMÍNIO 14 X 22,50 X 1,50MM	5
	ARRUELA ALUMÍNIO 12 X 19,50 X 1,50MM	25

88321926 KIT DE ARRUELAS DO JOGO INFERIOR		
Nº ABR	DESCRIÇÃO	QTD
	ARRUELA COBRE 18 X 24 X 1,50MM	1
	ARRUELA ALUMÍNIO 14 X 22,50 X 1,50MM	3
	ARRUELA ALUMÍNIO 12 X 19,50 X 1,50MM	13

CUMMINS ISB4.5/QSB4.5 16VÁLVULAS ELETRÔNICO(EURO 5)

Nº JOGO		DESCRIÇÃO				
68310772		JOGO DE JUNTAS COMPLETO CUMMINS ISB4.5 / QSB4.5 SEM RETENTORES				1
78310772		JOGO DE JUNTAS COMPLETO CUMMINS ISB4.5 / QSB4.5 COM RETENTORES				2
68330771		JOGO DE JUNTAS SUPERIOR CUMMINS ISB4.5 / QSB4.5 SEM RETENTORES				3
78330771		JOGO DE JUNTAS SUPERIOR CUMMINS ISB4.5 / QSB4.5 COM RETENTORES				4
68330770		JOGO DE JUNTAS INFERIOR CUMMINS ISB4.5 / QSB4.5 SEM RETENTORES				5
78330770		JOGO DE JUNTAS INFERIOR CUMMINS ISB4.5 / QSB4.5 COM RETENTORES				6
Nº ABR	Nº CUMMINS	DESCRIÇÃO				
58330402	4932209	JUNTA DO CABEÇOTE Ø 110 MM			1	1
58329340	4899228	JUNTA DA TAMPA DAS VÁLVULAS			1	1
58325431	3955339	JUNTA DO COLETOR DE ESCAPAMENTO			4	4
58313067	3938153	JUNTA DO COLETOR DE ADMISSÃO			1	1
58327940	4899877	JUNTA DO CÂRTER	1	1		1
RE05287T	3909410	RETENTOR TRASEIRO DO VIRABREQUIM	1			1
RE08427T	4890832	RETENTOR DIANTEIRO DO VIRABREQUIM	1			1
RE08429V	3955393	RETENTOR DA HASTE DAS VÁLVULAS			16	16
58304616	3939258	JUNTA DA BOMBA DE COMBUSTÍVEL	1	1		1
58310616	4898280	JUNTA DA BOMBA HIDRÁULICA	1	1		1
58318467	3969988	JUNTA DA CONEXÃO DE ADMISSÃO			1	1
58328030	4898301	JUNTA DA CONEXÃO DA SUÇÃO DE ÓLEO	1	1		1
58328130	4890024	BORRIFADOR DO BICO DO RESFRIADOR	4	4		4
58328247	4895742	JUNTA DO RESFRIADOR DE ÓLEO	1	1		1
58328347	4896409	JUNTA DO FILTRO DO ÓLEO			1	1
58328467	4896897	JUNTA DA BOMBA HIDRÁULICA	1	1		1
58329132	3932475	JUNTA DA MESA DA TURBINA			1	1
58329440	4899230	JUNTA DA TAMPA DAS VÁLVULAS INFERIOR			1	1
58330767	3819900	JUNTA DO RETORNO DO ÓLEO DO TURBO			1	1
58330830	4896254	JUNTA DO TUBO DE ESCAPE			1	1
58330967	3949562	JUNTA DO TUBO DE ÓLEO	1	1		1
88320440		KIT DE BORRACHAS DO JOGO SUPERIOR			1	1
88320540		KIT DE ARRUELAS E BORRACHAS DO JOGO INFERIOR	1	1		1

● VENDE-SE AVULSO

APLICAÇÃO

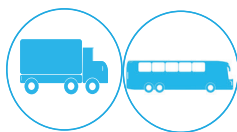

FORD 1119E 2014/...1319E 2012/17 ; 1419E 2016/...1519E 2013/...816E 2012/...

AGRALE 14000 2013/...14000S 2017...AGRALE ÔNIBUS MA 15.0 2013/...

CUMMINS ISB4.5/QSB4.5 16VÁLVULAS ELETRÔNICO(EURO 5)

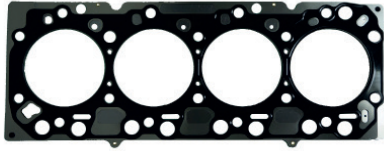

58330402 - DIÂMETRO 110 MM

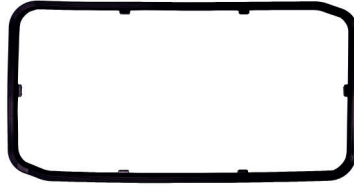

58327940

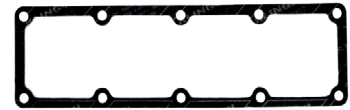

58313067



58329340



58329440



58328130



58328467



58310616



RE08427T



RE05287T



58328347



58328247



58330830



58325431



58304616



58330767



58318467



58329132



58330967



58328030



RE08429V



88320540



88320440

CUMMINS ISB6.7/QSB6.7 24VÁLVULAS ELETRÔNICO(EURO 5)

Nº JOGO	DESCRIÇÃO						
68310752	JOGO DE JUNTAS COMPLETO CUMMINS ISB6.7/QSB6.7 24V SEM RETENTORES		1				
78310752	JOGO DE JUNTAS COMPLETO CUMMINS ISB6.7/QSB6.7 24V COM RETENTORES		2				
68330751	JOGO DE JUNTAS SUPERIOR CUMMINS ISB6.7/QSB6.7 24V SEM RETENTORES		3				
78330751	JOGO DE JUNTAS SUPERIOR CUMMINS ISB6.7/QSB6.7 24V COM RETENTORES		4				
68330750	JOGO DE JUNTAS INFERIOR CUMMINS ISB6.7/QSB6.7 24V SEM RETENTORES		5				
78330750	JOGO DE JUNTAS INFERIOR CUMMINS ISB6.7/QSB6.7 24V COM RETENTORES		6				
Nº ABR	Nº CUMMINS	DESCRIÇÃO					
58330302	4932210	JUNTA DO CABEÇOTE Ø 110 MM		1	1	1	1
58328740	4899231	JUNTA DA TAMPA DAS VÁLVULAS		1	1	1	1
58325431	3955339	JUNTA DO COLETOR DE ESCAPAMENTO		6	6	6	6
58310067	3947530/3931347	JUNTA DO COLETOR DE ADMISSÃO		1	1	1	1
58328540	4897861/4948344	JUNTA DO CÂRTER	1	1		1	1
RE05287T	390940	RETENTOR TRASEIRO DO VIRABREQUIM Ø 130X150X14MM	1			1	
RE08427T	480832	RETENTOR DIANTEIRO DO VIRABREQUIM Ø 78X100X12,5/16MM	1			1	
RE08429V	3955393	RETENTOR DA HASTE DAS VÁLVULAS		24		24	
58304616	3939258	JUNTA DA BOMBA DE COMBUSTÍVEL	1	1		1	1
58310616	4898280	JUNTA DA BOMBA HIDRÁULICA	1	1		1	1
58318467	3969988	JUNTA DA CONEXÃO DE ADMISSÃO		1	1	1	1
58328030	4898301	JUNTA DA CONEXÃO DA SUÇÃO DE ÓLEO	1	1		1	1
58328130	4890024	BORRIFADOR DO BICO DO RESFRIADOR	6	6		1	1
58328247	4895742	JUNTA DO RESFRIADOR DE ÓLEO	1	1		1	1
58328347	4896409	JUNTA DO FILTRO DO ÓLEO	1	1		1	1
58328467	4896897	JUNTA DA BOMBA HIDRÁULICA	1	1		1	1
58328640	4899226	JUNTA DA TAMPA DAS VÁLVULAS INFERIOR		1	1	1	1
58329132	3932475	JUNTA DA MESA DA TURBINA		1	1	1	1
58330767	3819900	JUNTA DO RETORNO DO ÓLEO DO TURBO		1	1	1	1
58330830	4896254	JUNTA DO TUBO DE ESCAPE		1	1	1	1
58330967	3949562	JUNTA DO TUBO DE ÓLEO	1	1		1	1
88320640		KIT DE ARRUELAS E BORRACHAS DO JOGO SUPERIOR		1	1	1	1
88321226		KIT DE ARRUELAS DO JOGO INFERIOR	1	1		1	1
88321346		KIT DE BORRACHAS DO JOGO INFERIOR	1	1		1	1

● VENDE-SE AVULSO

APLICAÇÃO

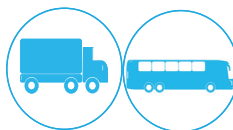

FORD 1723E/2423E/2429E/2629E 2012/...1729E 2014/2018 ; 1731E/2431E/2631E/3031E/3131E 2018/...2623E 2013/...

3129E 2016/...AGRALE MA 17.0 2013/...

CUMMINS ISB6.7/QSB6.7 24VÁLVULAS ELETRÔNICO(EURO 5)



58330302 - DIÂMETRO 110 MM



58328540

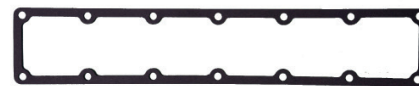

58310067

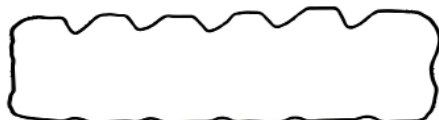

58328640



58328740



58328130



58328467



58310616



RE08427T



RE20528T



58328347



58328247



58330830



58325431



58304616



58330767



58318467



58329132



58330967



58328030



RE08429T



88320640

88321346 KIT DE BORRACHAS DO JOGO INFERIOR		
Nº ABR	DESCRIÇÃO	QTD
	VEDADOR 12,30 X 2,40MM	12
	VEDADOR 56,74 X 3,50MM	1
	VEDADOR 62,00 X 1,50MM	1
	VEDADOR 24,00 X 2,50MM	1
	VEDADOR 21,89 X 2,65MM	1
	VEDADOR 20,35 X 1,78MM	1
	VEDADOR 30,00 X 2,50MM	1
	VEDADOR 29,74 X 3,50MM	1
	VEDADOR 14,00 X 2,50MM	1
	VEDADOR 25,50 X 2,50MM	1
	VEDADOR 11,00 X 1,50MM	1
	VEDADOR 23,50 X 2,62MM	2
	VEDADOR 50,00 X 3,00MM	1

88321226 KIT DE ARRUELAS DO JOGO INFERIOR		
Nº ABR	DESCRIÇÃO	QTD
	ARRUELA ALUMÍNIO 14 X 22 X 1,50MM	6
	ARRUELA ALUMÍNIO 8 X 13,5 X 1,00MM	6
	ARRUELA COBRE 8,5 X 14 X 1,50MM	6

CUMMINS ISF 4 CILINDROS 3.8LITROS 16VÁLVULAS (EURO 5)

Nº JOGO		DESCRIÇÃO		
78310732		JOGO DE JUNTAS COMPLETO CUMMINS ISF 4 CILINDROS 3.8L COM RETENTORES		1
78330732		JOGO DE JUNTAS SUPERIOR CUMMINS ISF 4 CILINDROS 3.8L COM RETENTORES		2
78330730		JOGO DE JUNTAS INFERIOR CUMMINS ISF 4 CILINDROS 3.8L COM RETENTORES		3
Nº ABR	Nº CUMMINS	DESCRIÇÃO		
58330602	4943051	JUNTA DO CABEÇOTE Ø 107 MM	1	1
58331140	4946239	JUNTA DA TAMPA DAS VÁLVULAS	1	1
58325431	3955339	JUNTA DO COLETOR DE ESCAPAMENTO	4	4
58331330	4983020	JUNTA DO COLETOR DE ADMISSÃO	1	1
58331240	4995750	JUNTA DO CÁRTER	1	1
RE05287T	3909410	RETENTOR TRASEIRO DO VIRABREQUIM 130X150X14MM	1	1
RE08427T	4890832	RETENTOR DIANTEIRO DO VIRABREQUIM 70X100X12,5/16MM	1	1
RE08429V	3955393	RETENTOR DA HASTE DAS VÁLVULAS 6,25X12,6X14MM	1	1
58328467	4896897	JUNTA DA BOMBA HIDRÁULICA	16	16
58329132	3932475	JUNTA DA MESA DA TURBINA	1	1
58330767	3819900	JUNTA DO RETORNO DO ÓLEO DO TURBO	1	1
58331430	4990276	JUNTA DO FILTRO DE ÓLEO	1	1
58331530	4980605	JUNTA DA BOMBA DE ÓLEO	1	1
58331640	4940584	VEDADOR DA TAMPA DE VÁLVULAS	1	1
58331730	5255538	JUNTA DO TUBO DE ESCAPE	4	4
58331830	4995186	JUNTA DA SAÍDA DO TUBO DE ESCAPE	1	1
88320840		KIT DE ARRUELAS E BORRACHAS	1	1
88321140		KIT DE ARRUELAS E BORRACHAS DO JOGO SUPERIOR		1
RE09123F		RETENTOR DA BOMBA DE ÓLEO 24X40X7MM	1	

• VENDE-SE AVULSO

APLICAÇÃO

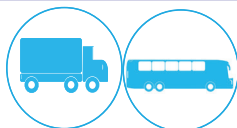

VOLKSWAGEN 8160/9160 2012/...10160 2013/...13160 2015/...DELIVERY 9170/11180/13180 2018/...
VOLKSWAGEN 8160 OD 2012/...9160 OD 2014/...10160 ODR 2017/...
AGRALE 8700 LX/10000 LX 2016/17 8700/10000 2013/...A7500/A8700/A10000 2016/...8700S/8700TR/10000S 2017/...
VOLARE V5/V6/V8 2012/14 W6 FLY/W7 FLY 2013/14 V6L 2014/17 W6/W7/V8L 2014/...V9L 2017/...
FOTON 10-16DT 2017/...

CUMMINS ISF 4 CILINDROS 3.8LITROS 16VÁLVULAS (EURO 5)

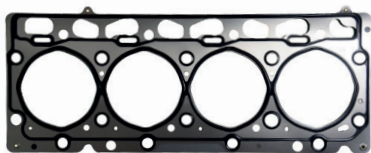

58330602 - DIÂMETRO 107 MM



58331140



58331330

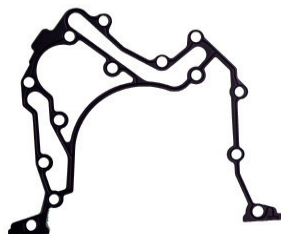

58331530



58331430



58331240



58332140



58328467



58325431



58331730



58331830



58330767



58329132



RE08427T



RE05287T



RE09123F



58331640



RE08429V

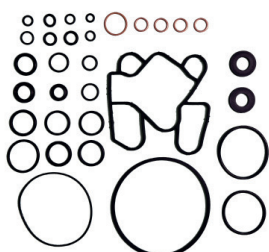

88520840

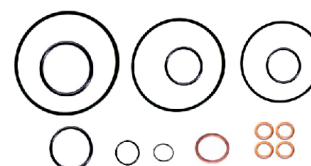

88321140

CUMMINS ISF 4 CILINDROS.2.8LITROS 16VÁLVULAS (EURO 5)

Nº JOGO		DESCRIÇÃO		
78310712		JOGO DE JUNTAS COMPLETO CUMMINS ISF 4 CILINDROS 2.8L COM RETENTORES		1
78330712		JOGO DE JUNTAS SUPERIOR CUMMINS ISF 4 CILINDROS 2.8L COM RETENTORES		2
78330710		JOGO DE JUNTAS INFERIOR CUMMINS ISF 4 CILINDROS 2.8L COM RETENTORES		3
Nº ABR	Nº CUMMINS	DESCRIÇÃO		
58330502	5257187	JUNTA DO CABEÇOTE Ø 95,6 MM	1	1
58332040	5255312	JUNTA DA TAMPA DAS VÁLVULAS	1	1
58332330	5261421	JUNTA DO COLETOR DE ESCAPAMENTO	1	1
56332267	4983654	JUNTA DO COLETOR DE ADMISSÃO	1	1
58331040	4980644	JUNTA DO CÂRTER 1 BOCAL	1	1
58332140	5256541	JUNTA DO CÂRTER 2 BOCAL	1	1
RE09122T	5265267	RETENTOR TRASEIRO DO VIRABREQUIM	1	1
RE09118T	5265266	RETENTOR DIANTEIRO DO VIRABREQUIM	1	1
RE09119F	4976170	RETENTOR DA HASTE DAS VÁLVULAS 6,25X12,6X14MM	16	16
58329132	3932475	JUNTA DA MESA DA TURBINA	1	1
58330767	3819900	JUNTA DO RETORNO DO ÓLEO DO TURBO	1	1
58331730	5255538	JUNTA DO TUBO DE ESCAPE	1	1
58331830	4995186	JUNTA DA SAÍDA DO TUBO DE ESCAPE	1	1
58331940		JUNTA DA TAMPA DAS VÁLVULAS	1	1
58332440	5255313	VEDADOR DA TAMPA DE VÁLVULAS	4	4
58332540	5255314	RETENTOR TUBO VENTILAÇÃO	4	4
58332630	5262686	JUNTA DA BOMBA DE ÓLEO	1	1
58332730	5264426	JUNTA DA BOMBA DE VÁCUO	1	1
58332840	5264477	JUNTA DA CAIXA DE ENGRENAGEM	1	1
58332940	5262903	JUNTA DO RESFRIADOR DE ÓLEO	1	1
58333040	5263530	JUNTA DA CAIXA DE ENGRENAGEM	1	1

• VENDE-SE AVULSO

APLICAÇÃO



VOLKSWAGEN DELIVERY 4150/6160/EXPRESS 2017/...FORD F350 2015/...F4 MILHA 2015/...F4000 2015/...

AGRALE MARRUÁ M200 2015/...AGRALE MA 8.7/MA 9.2/MA 10.0 2013/...VOLARE CINCO 2016/...

FOTON 3.5-12DT/3.5-12ST/3.5-14DT/3.5-14ST/AUMARK 3.5-11DT/3.5-11ST 2017/...

CUMMINS ISF 4 CILINDROS.2.8LITROS 16VÁLVULAS (EURO 5)



58330502 - DIÂMETRO 95,6 MM



58332267



58332330

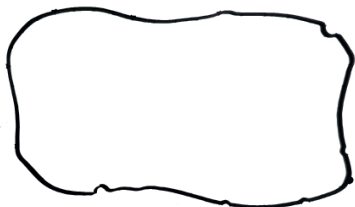

58332040



58332330

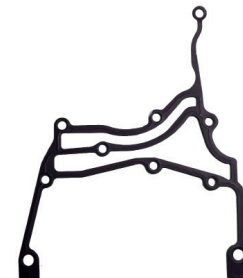

58332630



58331940



58332940



58332840



58331040



58332140



58332730



58331730



58331830



RE09122T



RE09118T



58332440



58332540



58329132



58330767



58333040



RE09119F



MERCEDES

A large, light gray, faded version of the ABR logo, consisting of three slanted parallel lines followed by the letters 'ABR'.

MERCEDES

Nº ABR	MOTOR	DESCRIÇÃO		PÁGINA
66116081	OM314	JOGO DE JUNTAS COMPLETO	SEM RETENTORES E COM JUNTA DE CABEÇOTE 98,5 MM	44
76116081	OM314	JOGO DE JUNTAS COMPLETO	COM RETENTORES E COM JUNTA DE CABEÇOTE 98,5 MM	44
76126081	OM314	JOGO DE JUNTAS COMPLETO	COM RETENTORES E COM JUNTA DE CABEÇOTE 100,0 MM	44
76136081	OM314	JOGO DE JUNTAS SUPERIOR	COM RETENTORES E COM JUNTA DE CABEÇOTE 98,5 MM	44
76121681	OM364	JOGO DE JUNTAS COMPLETO	COM RETENTORES E COM JUNTA DE CABEÇOTE 98,5 MM	46
76111681	OM364	JOGO DE JUNTAS COMPLETO	COM RETENTORES E COM JUNTA DE CABEÇOTE 100,0 MM	46
76121671	OM364A	JOGO DE JUNTAS COMPLETO	COM RETENTORES E COM JUNTA DE CABEÇOTE 98,5 MM	46
76111671	OM364A	JOGO DE JUNTAS COMPLETO	COM RETENTORES E COM JUNTA DE CABEÇOTE 100,0 MM	46
76131671	OM364/364A	JOGO DE JUNTAS SUPERIOR	COM RETENTORES E COM JUNTA DE CABEÇOTE 98,5 MM	46
76131681	OM364/364A	JOGO DE JUNTAS SUPERIOR	COM RETENTORES E COM JUNTA DE CABEÇOTE 100,0 MM	46
76141721	OM352	JOGO DE JUNTAS COMPLETO	COM RETENTORES E COM JUNTA DE CABEÇOTE 98,5 MM	50
76121721	OM352	JOGO DE JUNTAS COMPLETO	COM RETENTORES E COM JUNTA DE CABEÇOTE 100,0 MM	50
76141031	OM352A/LA	JOGO DE JUNTAS COMPLETO	COM RETENTORES E COM JUNTA DE CABEÇOTE 98,5 MM	50
76121031	OM352A/LA	JOGO DE JUNTAS COMPLETO	COM RETENTORES E COM JUNTA DE CABEÇOTE 100,0 MM	50
76131721	OM352A/LA	JOGO DE JUNTAS SUPERIOR	COM RETENTORES E COM JUNTA DE CABEÇOTE 98,5 MM	50
76131031	OM352A/LA	JOGO DE JUNTAS SUPERIOR	COM RETENTORES E COM JUNTA DE CABEÇOTE 100,0 MM	50
66113121	OM355/5 CILINDROS	JOGO DE JUNTAS COMPLETO	SEM RETENTORES	54
76113121	OM355/5 CILINDROS	JOGO DE JUNTAS COMPLETO	COM RETENTORES	54
76133121	OM355/5 CILINDROS	JOGO DE JUNTAS SUPERIOR	COM RETENTORES	54
66112501	OM355/6 CILINDROS	JOGO DE JUNTAS COMPLETO	SEM RETENTORES	58
76112501	OM355/6 CILINDROS	JOGO DE JUNTAS COMPLETO	COM RETENTORES	58
76132501	OM355/6 CILINDROS	JOGO DE JUNTAS SUPERIOR	COM RETENTORES	58
76121691	OM366	JOGO DE JUNTAS COMPLETO	COM RETENTORES E COM JUNTA DE CABEÇOTE 98,5 MM	62
76111691	OM366	JOGO DE JUNTAS COMPLETO	COM RETENTORES E COM JUNTA DE CABEÇOTE 100,0 MM	62
76121701	OM366A	JOGO DE JUNTAS COMPLETO	COM RETENTORES E COM JUNTA DE CABEÇOTE 98,5 MM	62
76141701	OM366A	JOGO DE JUNTAS COMPLETO	COM RETENTORES E COM JUNTA DE CABEÇOTE 100,0 MM	62
76112791	OM366LA	JOGO DE JUNTAS COMPLETO	COM RETENTORES E COM JUNTA DE CABEÇOTE 100,0 MM	62
76131701	OM366A/366LA	JOGO DE JUNTAS SUPERIOR	COM RETENTORES E COM JUNTA DE CABEÇOTE 98,5 MM	62
76131691	OM366A/366LA	JOGO DE JUNTAS SUPERIOR	COM RETENTORES E COM JUNTA DE CABEÇOTE 100,0 MM	62
76196115	OM447A/447LA	JOGO DE JUNTAS COMPLETO	COM RETENTORES	66
66196115	OM447A/447LA	JOGO DE JUNTAS COMPLETO	SEM RETENTORES	66
76196125	OM449A/449LA	JOGO DE JUNTAS COMPLETO	COM RETENTORES	66
66196125	OM449A/449LA	JOGO DE JUNTAS COMPLETO	SEM RETENTORES	66
76136125	OM447/OM449	JOGO DE JUNTAS MONOCILÍNDRICO	COM RETENTORES	66
66136125	OM447/OM449	JOGO DE JUNTAS MONOCILÍNDRICO	SEM RETENTORES	66
66114611	OM457LA	JOGO DE JUNTAS COMPLETO	SEM RETENTORES E SEM ANÉIS DE CAMISA (ATÉ MOTOR 32558)	68
76114611	OM457LA	JOGO DE JUNTAS COMPLETO	COM RETENTORES E SEM ANÉIS DE CAMISA (ATÉ MOTOR 32558)	68
76114619	OM457LA	JOGO DE JUNTAS COMPLETO	COM RETENTORES E COM ANÉIS DE CAMISA (ATÉ MOTOR 32558)	68
66134611	OM457LA	JOGO DE JUNTAS MONOCILÍNDRICO	SEM RETENTORES E SEM ANÉIS DE CAMISA (ATÉ MOTOR 32558)	68
76134611	OM457LA	JOGO DE JUNTAS MONOCILÍNDRICO	COM RETENTORES E SEM ANÉIS DE CAMISA (ATÉ MOTOR 32558)	68
76134619	OM457LA	JOGO DE JUNTAS MONOCILÍNDRICO	COM RETENTORES E COM ANÉIS DE CAMISA (ATÉ MOTOR 32558)	68
66114631	OM457LA	JOGO DE JUNTAS COMPLETO	SEM RETENTORES E SEM ANÉIS DE CAMISA (APÓS MOTOR 32559)	70
76114631	OM457LA	JOGO DE JUNTAS COMPLETO	COM RETENTORES E SEM ANÉIS DE CAMISA (APÓS MOTOR 32559)	70
76114639	OM457LA	JOGO DE JUNTAS COMPLETO	COM RETENTORES E COM ANÉIS DE CAMISA (APÓS MOTOR 32559)	70
76134599	OM457LA	JOGO DE JUNTAS MONOCILÍNDRICO	COM RETENTORES E COM ANÉIS DE CAMISA (APÓS MOTOR 32559)	70
76134609	OM457LA	JOGO DE JUNTAS MONOCILÍNDRICO	COM RETENTORES E COM ANÉIS DE CAMISA (APÓS MOTOR 32559)	70
76114651	OM611	JOGO DE JUNTAS COMPLETO	COM RETENTORES	72
76134651	OM611	JOGO DE JUNTAS SUPERIOR	COM RETENTORES	72
76119041	OM904	JOGO DE JUNTAS COMPLETO	COM RETENTORES PARA TAMPA DE VÁLVULAS DE PLÁSTICO	74
66119041	OM904	JOGO DE JUNTAS COMPLETO	SEM RETENTORES PARA TAMPA DE VÁLVULAS DE PLÁSTICO	74
76119241	OM924	JOGO DE JUNTAS COMPLETO	COM RETENTORES PARA TAMPA DE VÁLVULAS DE PLÁSTICO	74
66119241	OM924	JOGO DE JUNTAS COMPLETO	SEM RETENTORES PARA TAMPA DE VÁLVULAS DE PLÁSTICO	74
76139041	OM904	JOGO DE JUNTAS SUPERIOR	COM RETENTORES PARA TAMPA DE VÁLVULAS DE PLÁSTICO	74
76139241	OM904	JOGO DE JUNTAS SUPERIOR	COM RETENTORES PARA TAMPA DE VÁLVULAS DE PLÁSTICO	74
76119061	OM906	JOGO DE JUNTAS COMPLETO	COM RETENTORES PARA TAMPA DE VÁLVULAS DE PLÁSTICO	76
66119061	OM906	JOGO DE JUNTAS COMPLETO	SEM RETENTORES PARA TAMPA DE VÁLVULAS DE PLÁSTICO	76
76119261	OM926	JOGO DE JUNTAS COMPLETO	COM RETENTORES PARA TAMPA DE VÁLVULAS DE PLÁSTICO	76
66119291	OM926	JOGO DE JUNTAS COMPLETO	SEM RETENTORES PARA TAMPA DE VÁLVULAS DE PLÁSTICO	76
76136061	OM906	JOGO DE JUNTAS SUPERIOR	COM RETENTORES PARA TAMPA DE VÁLVULAS DE PLÁSTICO	76
76139261	OM926	JOGO DE JUNTAS SUPERIOR	COM RETENTORES PARA TAMPA DE VÁLVULAS DE PLÁSTICO	76
76114682	OM612	JOGO DE JUNTAS COMPLETO	COM RETENTORES E COM FLANGE TRASEIRA	78
76134682	OM612	JOGO DE JUNTAS SUPERIOR	COM RETENTORES	78
76112702	OM651	JOGO DE JUNTAS COMPLETO	COM RETENTORES	80
76132702	OM651	JOGO DE JUNTAS SUPERIOR	COM RETENTORES	80
76114735	OM501(MOTOR 012091 ATÉ 084423)	JOGO DE JUNTAS COMPLETO	COM RETENTORES SEM ANEL DE CAMISA	82
76114745	OM501(MOTOR 084424 ATÉ 155295)	JOGO DE JUNTAS COMPLETO	COM RETENTORES SEM ANEL DE CAMISA	82
76114715	OM501(MOTOR 155296 ATÉ 377748)	JOGO DE JUNTAS COMPLETO	COM RETENTORES SEM ANEL DE CAMISA	82
76114725	OM501(APÓS MOTOR 377749)	JOGO DE JUNTAS COMPLETO	COM RETENTORES SEM ANEL DE CAMISA	82

MERCEDES

Nº ABR	MOTOR	DESCRIÇÃO		PÁGINA
76134735	OM501/502(MOTOR 012091 ATÉ 084423)	JOGO DE JUNTAS SUPERIOR	COM RETENTORES	82
76134745	OM501/502 (MOTOR 084424 ATÉ 155295)	JOGO DE JUNTAS SUPERIOR	COM RETENTORES	82
76134715	OM501/502 (MOTOR 155296 ATÉ 377748)	JOGO DE JUNTAS SUPERIOR	COM RETENTORES	82
76134725	OM501/502 (APÓS MOTOR 377749)	JOGO DE JUNTAS SUPERIOR	COM RETENTORES	82
76134730	OM501 TODOS OS MOTORES	JOGO DE JUNTAS INFERIOR	COM RETENTORES SEM JUNTA DE CÁRTER	82
76134720	OM501 (ATÉ MOTOR 012090)	JOGO DE JUNTAS INFERIOR	COM RETENTORES COM JUNTA DE CÁRTER SOFT	82
76134710	OM501 (APÓS MOTOR 012091)	JOGO DE JUNTAS INFERIOR	COM RETENTORES COM JUNTA DE CÁRTER BORRACHA	82
76114755	OM502 (MOTOR 012091 ATÉ 084423)	JOGO DE JUNTAS COMPLETO	COM RETENTORES SEM ANEL DE CAMISA	84
76114765	OM502 (MOTOR 084424 ATÉ 155295)	JOGO DE JUNTAS COMPLETO	COM RETENTORES SEM ANEL DE CAMISA	84
76114775	OM502 (MOTOR 155296 ATÉ 377748)	JOGO DE JUNTAS COMPLETO	COM RETENTORES SEM ANEL DE CAMISA	84
76114785	OM502 (APÓS MOTOR 377749)	JOGO DE JUNTAS COMPLETO	COM RETENTORES SEM ANEL DE CAMISA	84
76134735	OM501/502 (MOTOR 012091 ATÉ 084423)	JOGO DE JUNTAS SUPERIOR	COM RETENTORES	84
76134745	OM501/502 (MOTOR 084424 ATÉ 155295)	JOGO DE JUNTAS SUPERIOR	COM RETENTORES	84
76134715	OM501/502 (MOTOR 155296 ATÉ 377748)	JOGO DE JUNTAS SUPERIOR	COM RETENTORES	84
76134725	OM501/502 (APÓS MOTOR 377749)	JOGO DE JUNTAS SUPERIOR	COM RETENTORES	84
76134760	OM502 (TODOS)	JOGO DE JUNTAS INFERIOR	COM RETENTORES SEM JUNTA DE CÁRTER	84
76134750	OM502 (ATÉ MOTOR 012090)	JOGO DE JUNTAS INFERIOR	COM RETENTORES COM JUNTA DE CÁRTER SOFT	84
76134740	OM502 (APÓS MOTOR 012091)	JOGO DE JUNTAS INFERIOR	COM RETENTORES COM JUNTA DE CÁRTER BORRACHA	84

MERCEDES OM 314 4 CILINDROS 3.8L

Nº JOGO	DESCRIÇÃO
66116081	JOGO DE JUNTAS COMPLETO OM 314 COM JUNTA DE CABEÇOTE 98,5MM SEM RETENTORES 1
76116081 3435860090	JOGO DE JUNTAS COMPLETO OM 314 COM JUNTA DE CABEÇOTE 98,5MM COM RETENTORES 2
76126081 3435860090	JOGO DE JUNTAS COMPLETO OM 314 COM JUNTA DE CABEÇOTE 100,0MM COM RETENTORES 3
76136081	JOGO DE JUNTAS SUPERIOR OM 314 COM JUNTA DE CABEÇOTE 98,5MM COM RETENTORES 4

Nº ABR	Nº ORIGINAL	DESCRIÇÃO				
56108701	3140160220	JUNTA DO CABEÇOTE - OM314 / 364 / 364A Ø 98,5 MM	1	1	1	1
56131803	3640160320	JUNTA DO CABEÇOTE - OM314 / 364 / 364A Ø 100,0 MM		1		
56111616	3140160121	JUNTA DA TAMPA DAS VÁLVULAS	1	1	1	1
56112616	3141420180	JUNTA DO COLETOR DE ESCAPAMENTO	1	1	1	1
86115759	3145860201	KIT DE JUNTAS DO CÂRTER (4 PEÇAS)		1	1	1
56110359	3520150320	JUNTA DA TAMPA DA DISTRIBUIÇÃO		1	1	1
56134894	3430150080	JUNTA TRASEIRA DA DISTRIBUIÇÃO		1	1	1
50051167	0009979641	GAXETA (CONJUNTO COM 2 PEÇAS)		1	1	1
RE01810S		RETENTOR DIANTEIRO DO VIRABREQUIM		1	1	
56100298	3211310279	JUNTA DO CABEÇOTE DO COMPRESSOR		1	1	1
56100590	3522030680	JUNTA DO CAVALETE DE ÁGUA	2	2	2	2
56100890	71511022006	JUNTA DA TUBULAÇÃO DE ÁGUA		1	1	1
56102690	0000911280	JUNTA DA FLANGE DA BOMBA ALIMENTADORA		1	1	1
56106450	3520180180	JUNTA DA TAMPA DA BOMBA DE ÓLEO		1	1	1
56106595	3120760279	JUNTA DA BOMBA INJETORA		1	1	1
56106794	3211310079	JUNTA DA CAMISA DO COMPRESSOR		1	1	1
56109090	3271840280	JUNTA DA FLANGE DO FILTRO DE ÓLEO		1	1	1
56109398	3522010980	JUNTA DO SUPORTE DA BOMBA DE ÁGUA		1	1	1
56109498	3522010480	JUNTA DA CARCAÇA DA BOMBA DE ÁGUA		1	1	1
56109598	3522030080	JUNTA DA CARCAÇA DO TERMOSTATO	2	2	2	2
56109698	3522030480	JUNTA DO TERMOSTATO DA BOMBA DE ÁGUA	1	1	1	1
56109798	3522030780	JUNTA DO TERMOSTATO AO CABEÇOTE	1	1	1	1
56110116	071511060004	JUNTA DO TUBO DE SAÍDA DO ESCAPAMENTO		1	1	1
56110450	3120150680	JUNTA DA INSPEÇÃO DA DISTRIBUIÇÃO		1	1	1
56111590	3420150080	JUNTA DO RADIADOR DE ÓLEO		1	1	1
56111850	3140150622	JUNTA DA TAMPA LATERAL DAS VÁLVULAS		1	1	1
56112398	3140160280	JUNTA DO TUBO DE SUÇÇÃO	1	1	1	1
56114190	3141840379	JUNTA DA FLANGE DO FILTRO DE ÓLEO		1	1	1
60011680		KIT DE ARRUELAS		1	1	1
86101646		KIT DE BORRACHAS		1	1	1
86149640		KIT DE ARRUELAS E BORRACHAS DO JOGO SUPERIOR	1			

• VENDE-SE AVULSO

APLICAÇÃO

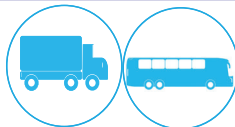

MERCEDES CAMINHÃO 608D/708D 1981/89

ÔNIBUS LO 608 1972/76

MERCEDES OM 314 4 CILINDROS 3.8L

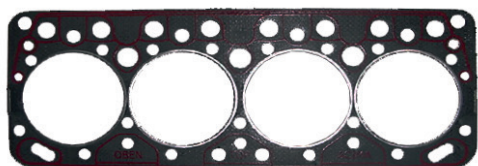

56108701-DIÂMETRO 98.5MM

56131803-DIÂMETRO 100 MM

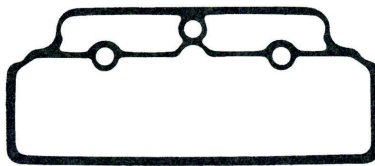

56111616

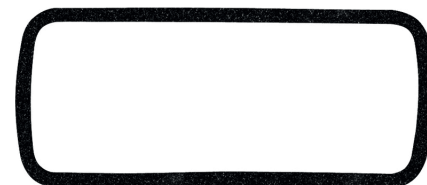

56111850

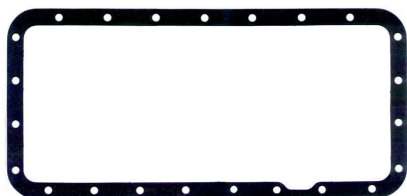

56111590



86115759



56134894



56112616



56110359



56100298



56110450



56106595



56106794

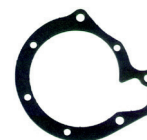

56109498



56109798



56100590



56102690



56100890



56109698



56110116



56109598



56109398



56109090



56114190



56106450



RE01810S



56112398



50051167

60011680		KIT DE ARRUELAS	
Nº ABR	DESCRIÇÃO		QTD
50012128	ARRUELA ALUMÍNIO 8,3 X 13,8 X 1,0MM		5
50014123	ARRUELA COBRE 9,5 X 20,0 X 1,0MM		4
50021229	ARRUELA ALUMÍNIO 14,0 X 13,8 X 1,5MM		2
50023329	ARRUELA ALUMÍNIO 16,20 X 22,0 X 1,5MM		2
50030425	ARRUELA ALUMÍNIO 26,0 X 32,0 X 2,0MM		2
50069329	ARRUELA ALUMÍNIO 20,2 X 24,0 X 1,5MM		1
50029723	ARRUELA DUPLA 8,0 X 12,0 X 1,0MM		4

86101646		KIT DE BORRACHA	
Nº ABR	DESCRIÇÃO		QTD
50005341	VADADOR 8,0 X 2,7MM		1
50035341	VEDADOR 31,5 X 3,8MM		4
50035441	ARRUELA BORRACHA 14,0 X 6,0 X 8,0MM		5
54386740	VEDADOR 12,5 X 2,6MM		1

86149640		KIT DE ARRUELAS E BORRACHA DO JOGO SUPERIOR	
Nº ABR	DESCRIÇÃO		QTD
50035441	VEDADOR 6,0 X 14,0 X 8,0MM		5
50014123	ARRUELA COBRE 9,5 X 20,0 X 1,00MM		4
56129723	ARRUELA DUPLA 8,0 X 12,0 X 1,00MM		4
50035341	VEDADOR 31,5 X 3,8MM		4

MERCEDES OM 364 4 CILINDROS 4.0L / OM 364A 4.0L TURBO

Nº JOGO		DESCRIÇÃO				
76121681		JOGO DE JUNTAS COMPLETO OM 364 COM JUNTA DE CABEÇOTE 98,5MM COM RETENTORES				1
76111681		JOGO DE JUNTAS COMPLETO OM 364 COM JUNTA DE CABEÇOTE 100,0MM COM RETENTORES				2
76121671		JOGO DE JUNTAS COMPLETO OM 364A COM JUNTA DE CABEÇOTE 98,5MM COM RETENTORES				3
76111671		JOGO DE JUNTAS COMPLETO OM 364A COM JUNTA DE CABEÇOTE 100,0MM COM RETENTORES				4
76131671		JOGO DE JUNTAS SUPERIOR OM 364 / OM 364A COM JUNTA DE CABEÇOTE 98,5MM COM RETENTORES				5
76131681		JOGO DE JUNTAS SUPERIOR OM 364 / OM 364A COM JUNTA DE CABEÇOTE 100,0MM COM RETENTORES				6
Nº ABR	Nº ORIGINAL	DESCRIÇÃO				
56108701	3640160320	JUNTA DO CABEÇOTE OM314 / 364 / 364A Ø 98,5 MM	1	1	1	1
56131803	3640160320	JUNTA DO CABEÇOTE OM314 / 364 / 364A Ø 100,0 MM	1	1	1	1
56131016	3640160021	JUNTA DA TAMPA DAS VÁLVULAS	1	1	1	1
56131231	3661420180	JUNTA DO COLETOR DE ESCAPAMENTO	3	3	3	3
56134716		JUNTA DO TUBO DE SAÍDA DO ESCAPAMENTO			1	1
86115759	3145860201	KIT DE JUNTAS DO CÂRTER (4 PEÇAS)			1	1
56126598	3520150520	JUNTA DIANTEIRA DA DISTRIBUIÇÃO			1	1
50051167	0009979641	GAXETA (CONJUNTO COM 2 PEÇAS)			1	1
RE01810S		RETENTOR DIANTEIRO DO VIRABREQUIM			1	1
56100590	3522030680	JUNTA DO CAVALETE DE ÁGUA	2	2	2	2
56100890	71511022006	JUNTA DA TUBULAÇÃO DE ÁGUA			1	1
56102690	000911280	JUNTA DA FLANGE DA BOMBA ALIMENTADORA			1	1
56106595	3120760279	JUNTA DA BOMBA INJETORA			1	1
56106794	3211310079	JUNTA DA CAMISA DO COMPRESSOR			1	1
56109498	3522010480	JUNTA DA CARÇA DA BOMBA DE ÁGUA			1	1
56110450	3120150680	JUNTA DA TAMPA DE INSPEÇÃO DA DISTRIBUIÇÃO			1	1
56111590	3420150080	JUNTA DO RADIADOR DE ÓLEO			1	1
56114190	3141840379	JUNTA DA FLANGE DO FILTRO DE ÓLEO			1	1
56127695	3141840179	JUNTA DO FILTRO DE ÓLEO			1	1
56128416	3521310280	JUNTA DO CABEÇOTE DO COMPRESSOR (MODERNO)			1	1
56129490	3662030080	JUNTA DO TERMOSTATO	1	1	1	1
56131316	3661410280	JUNTA DO COLETOR DE ADMISSÃO	2	2	2	2
56131941	3640150160	JUNTA DA TAMPA LATERAL DAS VÁLVULAS			1	1
56133590	3460180080	JUNTA DO TUBO DE ENCHIMENTO DE ÓLEO			1	1
56134894	3430150080	JUNTA TRASEIRA DA DISTRIBUIÇÃO			1	1
56139316	3521310380	JUNTA DO CABEÇOTE DO COMPRESSOR			1	1
56148390		JUNTA DO REFRIGERADOR DE ÓLEO			2	2
56148698	3641880080	JUNTA DO INTERCAMBIADOR			1	1
56149198	3030180079	JUNTA DO MEDIDOR DA VARETA DO ÓLEO			1	1
60011680		KIT DE ARRUELAS			1	1
86101646		KIT DE BORRACHAS			1	1
86120831		KIT DE JUNTAS DA TURBINA			1	1
86149640		KIT DE ARRUELAS E BORRACHAS DO JOGO SUPERIOR	1	1		

• VENDE-SE AVULSO

MERCEDES OM 364 4 CILINDROS 4.0L / OM 364A 4.0L TURBO

APLICAÇÃO

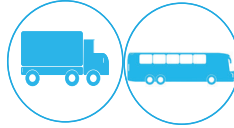

MERCEDES OM364 CAMINHÃO 709 1981/98;

MERCEDES OM364A CAMINHÃO 712 1995/99 ; 912 1987/95 ; 914 1994/99 ; 712 1992/03 ; 710 1992/12 ; 1214C 1997/99 ; 1114 1994/97

MERCEDES OM364A ÔNIBUS LO 610 2001/03 ; LO 712 2006/10 ; LO 812 1988/10 ; LO 813 1990/96 ; LO 814 1996/04 ; OF 812 1987/97

MERCEDES OM364 ÔNIBUS LO 809 1991/94

MERCEDES OM 364 4 CILINDROS 4.0L / OM 364A 4.0L TURBO

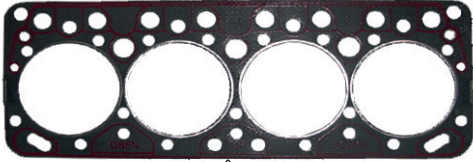

56108701-DIÂMETRO 98.5MM

56131803-DIÂMETRO 100 MM

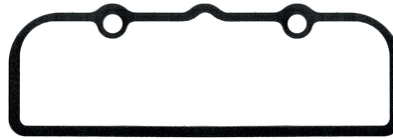

56131016



56131941

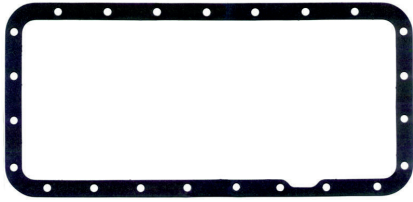

56111590



86115759



56134894



56126598

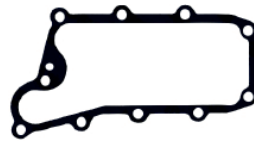

56148698

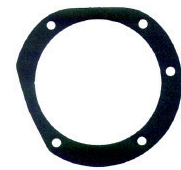

56106595



56131231



56128416



56131316



56109498



56130990



56100890



56100590



56134716



56106595



56102690



56133590



56129490



56127695



56114190



56109090



56110450



RE01810S



50051167

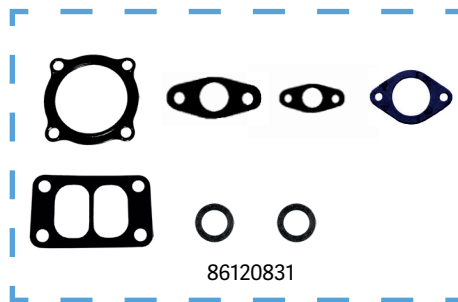

60011680		KIT DE ARRUELAS	
Nº ABR	DESCRIÇÃO	QTD	
50012128	ARRUELA ALUMÍNIO 8,3 X 13,8 X 1,0MM	5	
50014123	ARRUELA COBRE 9,5 X 20,0 X 1,0MM	4	
50021229	ARRUELA ALUMÍNIO 14,0 X 13,8 X 1,5MM	2	
50023329	ARRUELA ALUMÍNIO 16,20 X 22,0 X 1,5MM	2	
50030425	ARRUELA ALUMÍNIO 26,0 X 32,0 X 2,0MM	2	
50069329	ARRUELA ALUMÍNIO 20,2 X 24,0 X 1,5MM	1	
50029723	ARRUELA DUPLA 8,0 X 12,0 X 1,0MM	4	

86101646		KIT DE BORRACHA	
Nº ABR	DESCRIÇÃO	QTD	
50005341	VEDADOR 8,0 X 2,7MM	1	
50035341	VEDADOR 31,5 X 3,8MM	4	
50035441	ARRUELA BORRACHA 14,0 X 6,0 X 8,0MM	5	
54386740	VEDADOR 12,5 X 2,6MM	1	

86149640		KIT DE ARRUELA E BORRACHA DO JOGO SUPERIOR	
Nº ABR	DESCRIÇÃO	QTD	
50035441	VEDADOR 6,0 X 14,0 X 8,0 MM	5	
50014123	ARRUELA COBRE 9,5 X 20,0 X 1,0MM	4	
56129723	ARRUELA DUPLA 8,0 X 12,0 X 1,0MM	4	
50035341	VEDADOR 31,5 X 3,8 MM	4	

Nº JOGO		DESCRIÇÃO				
76141721		JOGO DE JUNTAS COMPLETO OM 352 COM JUNTA DE CABEÇOTE 98,5MM COM RETENTORES				1
76121721		JOGO DE JUNTAS COMPLETO OM 352 COM JUNTA DE CABEÇOTE 100,0MM COM RETENTORES				2
76141031		JOGO DE JUNTAS COMPLETO OM 352A/LA COM JUNTA DE CABEÇOTE 98,5MM COM RETENTORES				3
76121031		JOGO DE JUNTAS COMPLETO OM 352A/LA COM JUNTA DE CABEÇOTE 100,0MM COM RETENTORES				4
76131721		JOGO DE JUNTAS SUPERIOR 352A/LA COM JUNTA DE CABEÇOTE 98,5MM COM RETENTORES				5
76131031		JOGO DE JUNTAS SUPERIOR 352A/LA COM JUNTA DE CABEÇOTE 100,0MM COM RETENTORES				6
Nº ABR	Nº ORIGINAL	DESCRIÇÃO				
56149603	3520160220	JUNTA DO CABEÇOTE OM352 / 352A / 352LA / 366 / 366A / 366LA Ø 98,5 MM	1	1	1	1
56150201	3440167520	JUNTA DO CABEÇOTE OM352 / 352A / 352LA / 366 / 366A / 366LA Ø 100 MM	1	1	1	1
56110216	3520160421	JUNTA DA TAMPA DAS VÁLVULAS	1	1	1	1
86115531	3521420080	KIT DE JUNTAS DO COLETOR DE ESCAPAMENTO – TURBO / ASPIRADO	1	1	1	1
86112159	3445867001	KIT DE JUNTAS DO CÂRTER		1	1	1
56110359	3520150320	JUNTA DIANTEIRA DA DISTRIBUIÇÃO		1	1	1
56134894	3430150080	JUNTA TRASEIRA DA DISTRIBUIÇÃO		1	1	1
50051167	0009979641	GAXETA (CONJUNTO COM 2 PEÇAS)		1	1	1
RE01810S		RETENTOR DIAANTEIRO DO VIRABREQUIM		1	1	1
56100298	3211310279	JUNTA DO CABEÇOTE DO COMPRESSOR 77 MM		1	1	1
56100890	71511022006	JUNTA DA TUBULAÇÃO DE ÁGUA		1	1	1
56101216	302490080	JUNTA DO TUBO DE SAÍDA DO ESCAPAMENTO		1	1	
56102690	0000911280	JUNTA DA FLANGE DA BOMBA ALIMENTADORA		1	1	1
56106056	3520150522	JUNTA DA TAMPA LATERAL DAS VÁLVULAS		1	1	1
56106450	3120180280	JUNTA DA TAMPA DA TUBULAÇÃO DO ÓLEO		1	1	1
56106595	3120760279	JUNTA DA BOMBA INJETORA		1	1	1
56106794	3211310079	JUNTA DA CAMISA DO COMPRESSOR		1	1	1
56107716	3124921080	JUNTA DO TUBO DE SAÍDA DO ESCAPAMENTO				1
56109090	3271840280	JUNTA DA FLANGE DO FILTRO DE ÓLEO		1	1	1
56109398	3522010980	JUNTA DO SUPORTE DA BOMBA DE ÁGUA		1	1	1
56109498	3522010480	JUNTA DA CARÇAÇA DA BOMBA DE ÁGUA		1	1	1
56110450	3120150680	JUNTA DA TAMPA DE INSPEÇÃO DA DISTRIBUIÇÃO		1	1	1
56112298	3522011280	JUNTA DA BOMBA DE ÁGUA		1	1	1
56114190	3141840379	JUNTA DA FLANGE DO FILTRO DE ÓLEO		1	1	1
56128416	3521310280	JUNTA DO CABEÇOTE DO COMPRESSOR - MODERNO 94 MM		1	1	1
56139398	3521310380	JUNTA DO CABEÇOTE DO COMPRESSOR DE AR		1	1	1
56149098	3520180380	JUNTA DO TUBO DE RETORNO DE ÓLEO AO CÂRTER		1	1	1
60011720		KIT DE ARRUELA		1	1	1
86111175	445860018	KIT DE JUNTAS DO REFRIGERADOR DO ÓLEO		1	1	1
86120831		KIT DE JUNTAS DA TURBINA		1	1	
86124390		KIT DE JUNTAS DO REFRIGERADOR DE ÁGUA	1	1	1	1
SK861044		KIT DE BORRACHAS		1	1	1
86149726		KIT DE ARRUELAS DO JOGO SUPERIOR	1	1		
86149740		KIT DE BORRACHAS DO JOGO SUPERIOR	1	1		

• VENDE-SE AVULSO

APLICAÇÃO

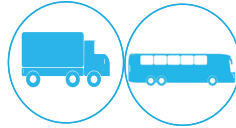

MERCEDES OM352 CAMINHÃO 1114 1981/90 ; 1113 1970/87 ; 1313/1513/2013 1970/89 ; 2213 1971/89;

MERCEDES OM352A/LA CAMINHÃO 2014 1975/89 ; 1514 1979/89 ; 1117 1981/90 ; 1316/1317/1516 1981/89 ; 1517 1986/87 ; 1518/2018 1981/91 ; 2216/2217 1981/87 ;

MERCEDES OM352 ÔNIBUS O 364 1978/84 ; OF 1113 1980/81 ; OF 1313/OH 1313 1970/86 ; OF 1314 1987/87

MERCEDES OM352A/LA ÔNIBUS O 365 1986/89 ; OF 1316 1982/86

MERCEDES OM 352 / OM 352A / OM 352LA 6 CILINDROS 5.7L

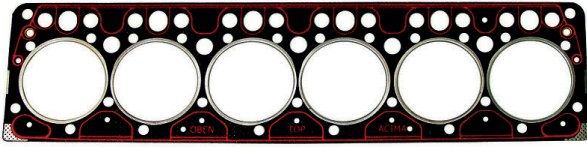

56149603-DIÂMETRO 98.5MM

56150201-DIÂMETRO 100 MM

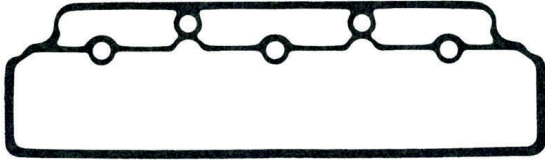

56110216



56106056

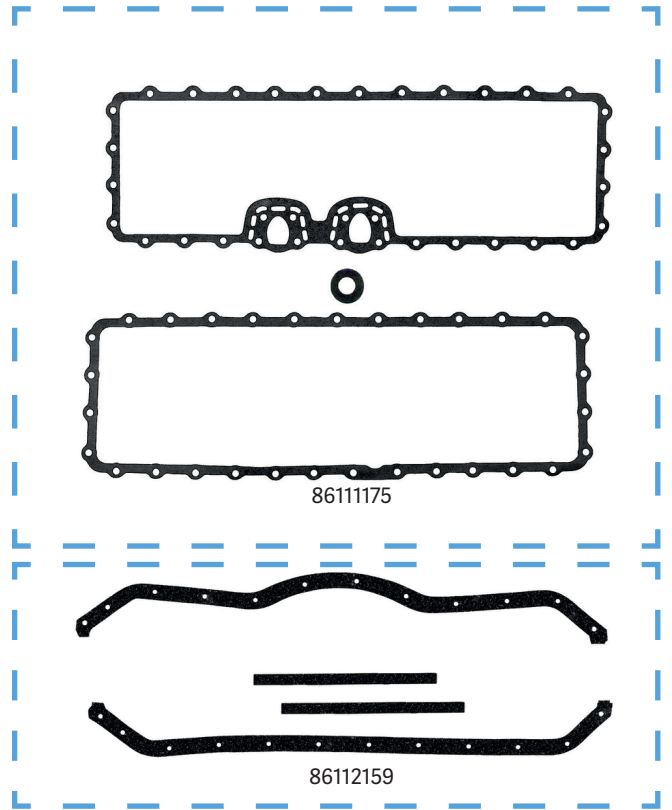

86111175

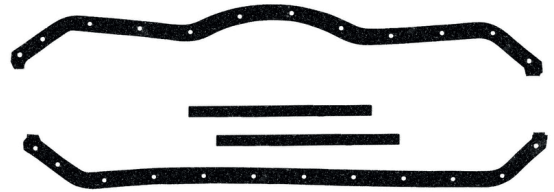

86112159

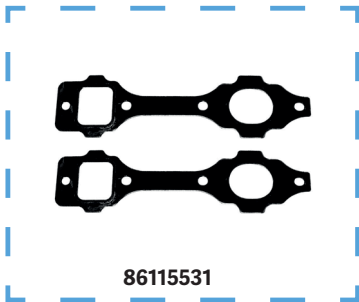

86115531



56110359



56126598



56134894



56128416



56100298



56106595



56109498



56101217



56107716



56149098



56106794



56102690



56110450

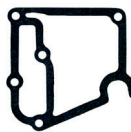

56112298

MERCEDES OM 352 / OM 352A / OM 352LA 6 CILINDROS 5.7L



56109398



56109090



56114190



RE01810S



56106450



50051167

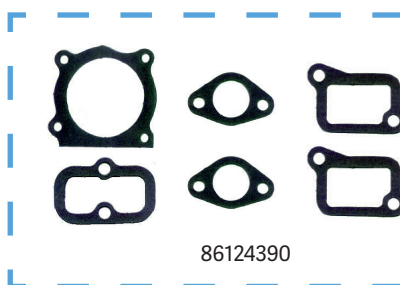

86124390

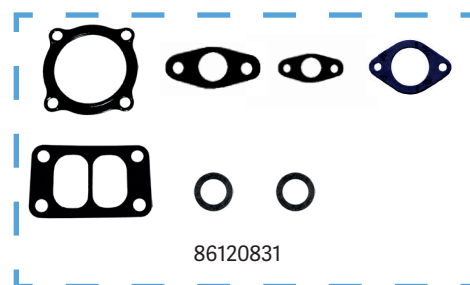

86120831

86149740 KIT DE BORRACHA DO JOGO SUPERIOR		
Nº ABR	DESCRIÇÃO	QTD
50035441	VEDADOR 6,0 X 14,0 X 8,0 MM	7
50035341	VEDADOR 31,5 X 3,8 MM	6

86149726 KIT DE ARRUELA DO JOGO SUPERIOR		
Nº ABR	DESCRIÇÃO	QTD
50014123	ARRUELA DE COBRE 9,5 X 20,0 X 1,0MM	6
56129723	ARRUELA DUPLA 8,0 X 12,0 X 1,0MM	6

60011720 KIT DE ARRUELA DO JOGO SUPERIOR		
Nº ABR	DESCRIÇÃO	QTD
	ARRUELA DE ALUMÍNIO 26,2X32,0 X1,5 MM	1
50011238	ARRUELA DE AÇO 8,0 X 12,0 X 1,0 MM	16
50011428	ARRUELA DE ALUMÍNIO 8,1 X 13,8 X 1,0 MM	6
50013860	ARRUELA DE FIBRA 9,0 X 18,0 X 0,4 MM	4
50014123	ARRUELA DE COBRE 9,5 X 20,0 X 1,0 MM	6
50015428	ARRUELA DE ALUMÍNIO 10,2 X 14,0 X 1,0 MM	6
50021129	ARRUELA DE ALUMÍNIO 14,0 X 18,0 X 1,5 MM	1
50021229	ARRUELA DE ALUMÍNIO 14,0 X 20,0 X 1,5 MM	18
50023329	ARRUELA DE ALUMÍNIO 16,2 X 22,0 X 1,5 MM	6
50025424	ARRUELA DE COBRE 18,3 X 23,8 X 1,5 MM	2
	ARRUELA DE ALUMÍNIO 24,3 X 30,0 X 1,5 MM	1
50030425	ARRUELA DE ALUMÍNIO 26,0 X 32,0 X 2,0 MM	1
50069229	ARRUELA DE ALUMÍNIO 18,2 X 21,9 X 1,5 MM	3
50072429	ARRUELA DE ALUMÍNIO 22,5 X 26,7 X 1,5 MM	1
56129723	ARRUELA DUPLA 8,0 X 12,0 X 1,0 MM	6

SK861044 KIT DE BORRACHA		
Nº ABR	DESCRIÇÃO	QTD
	VEDADOR 30,80X3,70MM	6
	VEDADOR 62,00X3,00MM	1
	VEDADOR 28,30X2,00MM	1
	VEDADOR 8,30X2,50MM	1
	VEDADOR 13,10X2,62MM	1
	VEDADOR 115,00X5,00MM	1
	VEDADOR 105,00X95,00X3,00MM	1
	VEDADOR 14,00X6,00X8,00MM	7
	VEDADOR 23,70X14,20X6,30MM	1
	VEDADOR 27,90X13,80X10,50MM	1

MERCEDES OM 355/5 CILINDROS 20V 9.7L

Nº JOGO		DESCRIÇÃO			
66113121 3555860290		JOGO DE JUNTAS COMPLETO OM 355/5 CILINDROS ASPIRADO / TURBO SEM RETENTORES	1		
76113121 3555860290		JOGO DE JUNTAS COMPLETO OM 355/5 CILINDROS ASPIRADO / TURBO COM RETENTORES	2		
76133121		JOGO DE JUNTAS SUPERIOR OM 355/5 CILINDROS ASPIRADO / TURBO COM RETENTORES	3		
Nº ABR	Nº ORIGINAL	DESCRIÇÃO			
56111903	3550160220	JUNTA DO CABEÇOTE – OM 355 3 CILINDROS Ø 133MM	1	1	1
56119803	3450160020	JUNTA DO CABEÇOTE – OM 355 2 CILINDROS Ø 133MM	1	1	1
56123503	3460160320	JUNTA DO CABEÇOTE – OM 355 1 CILINDROS Ø 133MM			
RE01860N		RETENTOR BOMBA INJETORA		1	
56111796	3460160022	JUNTA DA TAMPA DAS VÁLVULAS	5	5	5
86137816		KIT DE JUNTAS DO COLETOR DE ADMISSÃO 5 CILINDRO	1	1	1
86119790		KIT DE JUNTAS DO CÂRTER – OM 355 5 CILINDROS		1	1
56116359	3460150120	JUNTA DA TAMPA DE INSPEÇÃO DA DISTRIBUIÇÃO		1	1
RE00269S		RETENTOR TRASEIRO DO VIRABREQUIM		1	
RE01815F		RETENTOR HASTE DAS VÁLVULAS	20	20	
54117583	304334.0059	JUNTA DO SEMI-EIXO		1	1
56101139	3451420080	JUNTA DO COLETOR DO ESCAPAMENTO	5	5	5
56101216	3024900080	JUNTA DA SAÍDA DO ESCAPAMENTO		1	1
56101317	3444920080	JUNTA DA SAÍDA DO ESCAPAMENTO		1	1
56101490	3151840180	JUNTA DA TAMPA DO FILTRO DE ÓLEO		1	1
56101590	3262030080	JUNTA DA BOMBA DE ÁGUA		1	1
56101790	3152010180	JUNTA DA TAMPA DA BOMBA DE ÁGUA		1	1
56102294	0651810079	JUNTA DO SUPORTE DA BOMBA DE ÓLEO		1	1
56113950	3520180180	JUNTA DA TAMPA DO TUBO DO ÓLEO		1	1
56117890	356201.0180	JUNTA DA CARÇA DA BOMBA DE ÁGUA		1	1
56118090	3551840480	JUNTA DO SUPORTE DO FILTRO DE ÓLEO		1	1
56118190	3551880080	JUNTA DA CARÇA DO REFRIGERADOR DE ÓLEO		1	1
56118290	0001311679	JUNTA DO COMPRESSOR DE AR (SUPERIOR)		1	1
56118390	0001311579	JUNTA DO COMPRESSOR DE AR (INFERIOR)	2	2	
56118416	0001314380	JUNTA DO CABEÇOTE DO COMPRESSOR		1	1
56118590	0011311479	JUNTA DO SUPORTE DO COMPRESSOR DE AR		1	1
56118690	3460770380	JUNTA DO SUPORTE DA BOMBA INJETORA	2	2	
56118990	071511040017	JUNTA DO TUBO DE VENTILAÇÃO		1	1
56119090		JUNTA DA CARÇA DA BOMBA INJETORA	6	6	
56119290	0000911280	JUNTA DA FLANGE DA BOMBA ALIMENTADORA		1	1
56119690	3540150021	JUNTA DA TAMPA DOS CILINDROS OM 355 5 CILINDROS		1	1
56120190	071511026003	JUNTA DA TAMPA DA BOMBA DE ÓLEO		1	1
56122298	3450150022	JUNTA DA TAMPA LATERAL DAS VÁLVULAS		1	1
56133590	3460180080	JUNTA DO TUBO DE ENCHIMENTO DE ÓLEO		1	1
60013120		KIT DE ARRUELAS 5 CILINDROS		1	1
83721017		KIT DE JUNTAS DA TURBINA		1	1
86100846		KIT DE BORRACHA 5 CILINDROS		1	1
86117690	0001303920	KIT DE JUNTAS DO COMPRESSOR DE AR		1	1
86130890		KIT DE JUNTAS DA REFRIGERAÇÃO DE ÁGUA	1		
86149940		KIT DE ARRUELAS E BORRACHAS DO JOGO SUPERIOR OM 355 / 5 CILINDROS	1		

• VENDE-SE AVULSO

MERCEDES OM 355/5 CILINDROS 20V 9.7L

APLICAÇÃO

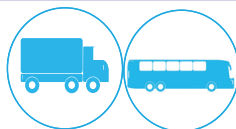

MERCEDES CAMINHÃO 1519 1973/89 ; 1520 1981/90 ; 2220 1987/91 ; 2219 1977/89 ; 1525 1985/90 ; 2225 1989/89

MERCEDES ÔNIBUS O 364 1978/86 ; O 370R 1984/87 ; O371 R 1987/90 ; O 371 UP 1987/93 ; OH 1419/OH 1517 1976/86

MERCEDES OM 355/5 CILINDROS 20V 9.7L



56111903 - DIÂMETRO 133MM



56119803 - DIÂMETRO 133MM



56123503 - DIÂMETRO 133MM



56119690



56111796



56117990



56122298

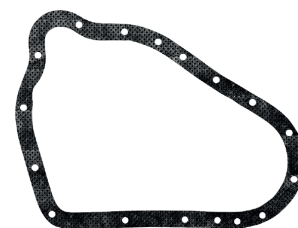

56116359

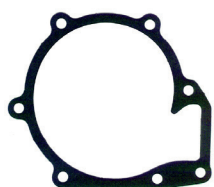

56117890

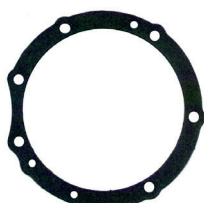

56118690



54117583

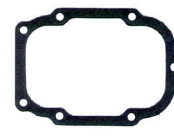

56118190



56119090



56118990



56102294



56101139



56101216



56101317



56101590



56133590



56119190



56118390



5618290



56119290



56118416



56101490



RE00269S



RE01860N



56118090



56113950



RE01815F

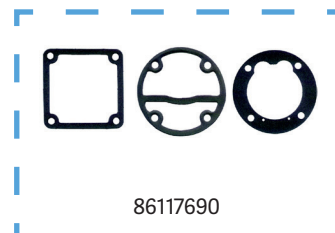
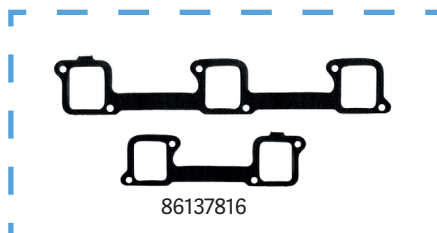
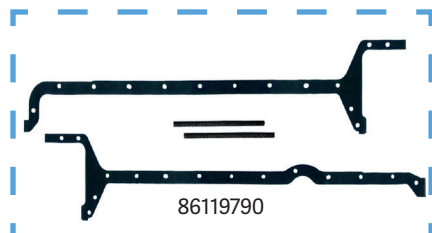

60013120		KIT DE ARRUELA	
Nº ABR	DESCRIÇÃO	QTD	
50034920	ARRUELA DE COBRE 35,3 X 41,0 X 2,0MM	7	
56129723	ARRUELA DE DUPLA 8,0 X 12,0 X 1,0MM	5	
50032729	ARRUELA DE ALUMÍNIO 30,3 X 35,9 X 1,50MM	2	
50012128	ARRUELA DE ALUMÍNIO 8,3 X 13,8 X 1,0MM	15	
50012928	ARRUELA DE ALUMÍNIO 8,3 X 11,4 X 1,0MM	12	
50021229	ARRUELA DE ALUMÍNIO 14,0 X 20,0 X 1,5MM	12	
50072429	ARRUELA DE ALUMÍNIO 22,5 X 26,7 X 1,5MM	6	
50027329	ARRUELA DE ALUMÍNIO 20,5 X 25,9 X 1,50MM	2	
50070329	ARRUELA DE ALUMÍNIO 18,5 X 21,7 X 1,5MM	2	
50023329	ARRUELA DE ALUMÍNIO 16,2 X 22,0 X 1,5MM	2	
50029525	ARRUELA DE ALUMÍNIO 24,2 X 29,4 X 2,0MM	2	
50021429	ARRUELA DE ALUMÍNIO 1 4,2 X 18,0 X 1,50MM	1	
50014123	ARRUELA DE COBRE 9,5 X 20,0 X 1,0MM	5	

86100846		KIT DE BORRACHAS	
Nº ABR	DESCRIÇÃO	QTD	
50007841	VEDADOR 27,0X3,3MM	2	
50028441	VEDADOR 117,0X4,8MM	1	
50035341	VEDADOR 30,8X3,7MM	5	
54386740	VEDADOR 12,5X2,6MM	1	
50040041	VEDADOR 18,0X2,5MM	1	
50002841	TUBO ARREFECIMENTO	5	
50003041	COLETOR ADMISSÃO	1	

86149940		KIT DE BORRACHAS	
Nº ABR	DESCRIÇÃO	QTD	
56129723	ARRUELA DUPLA 8,0 X 12,0 X 1,0MM	5	
50014123	ARRUELA COBRE 9,5 X 20,0 X 1,0MM	5	
50002841	ANEL VEDAÇÃO DO ARREFECIMENTO	5	
50003041	ANEL VEDAÇÃO DO COLETOR DE ADMISSÃO	1	

Nº JOGO		DESCRIÇÃO			
66112501 3555860290		JOGO DE JUNTAS COMPLETO OM 355/6 CILINDROS ASPIRADO / TURBO SEM RETENTORES	1		
76112501 3555860290		JOGO DE JUNTAS COMPLETO OM 355/6 CILINDROS ASPIRADO / TURBO COM RETENTORES	2		
76132501		JOGO DE JUNTAS SUPERIOR OM 355/6 CILINDROS ASPIRADO / TURBO COM RETENTORES	3		
Nº ABR	Nº ORIGINAL	DESCRIÇÃO			
56111903	3550160220	JUNTA DO CABEÇOTE – OM 355 3 CILINDROS Ø 133MM	2	2	2
56123503	3460160320	JUNTA DO CABEÇOTE – OM 355 1 CILINDRO Ø 133MM			
56111796	3460160022	JUNTA DA TAMPA DAS VÁLVULAS	6	6	6
86137716		KIT DE JUNTAS DO COLETOR DE ADMISSÃO 6 CILINDROS	1	1	1
86116190		KIT DE JUNTAS DO CÂRTER – OM 355 6 CILINDROS		1	1
56116359	3460150120	JUNTA DA TAMPA DE INSPEÇÃO DA DISTRIBUIÇÃO		1	1
RE00269S		RETENTOR TRASEIRO DO VIRABREQUIM		1	
RE01815F		RETENTOR HASTE DAS VÁLVULAS	24	24	
RE01860N		RETENTOR BOMBA INJETORA		1	
54117583	3043340059	JUNTA DO SEMI-EIXO		1	1
56101139	3451420080	JUNTA DO COLETOR DO ESCAPAMENTO	6	6	6
56101216	3024900080	JUNTA DA SAÍDA DO ESCAPAMENTO		1	1
56101317	3444920080	JUNTA DA SAÍDA DO ESCAPAMENTO		1	1
56101490	3151840180	JUNTA DA TAMPA DO FILTRO DE ÓLEO		1	1
56101590	326.2030080	JUNTA DA BOMBA DE ÁGUA		1	1
56101790	3152010180	JUNTA DA TAMPA DA BOMBA DE ÁGUA		1	1
56102294	0651810079	JUNTA DO SUPORTE DA BOMBA DE ÓLEO		1	1
56113950	3520180180	JUNTA DA TAMPA DO TUBO DO ÓLEO		1	1
56117790	3560150121	JUNTA DA TAMPA DOS CILINDROS OM 355 6 CILINDROS		1	1
56117890	3562010180	JUNTA DA CARÇA DA BOMBA DE ÁGUA		1	1
56117990	3550150022	JUNTA DA TAMPA LATERAL DAS VÁLVULAS		1	1
56118090	3551840480	JUNTA DO SUPORTE DO FILTRO DE ÓLEO		1	1
56118190	3551880080	JUNTA DA CARÇA DO REFRIGERADOR DE ÓLEO		1	1
56118290	0001311679	JUNTA DO COMPRESSOR DE AR (SUPERIOR)		1	1
56118390	0001311579	JUNTA DO COMPRESSOR DE AR (INFERIOR)	2	2	
56118416	0001314380	JUNTA DO CABEÇOTE DO COMPRESSOR		1	1
56118590	0011311479	JUNTA DO SUPORTE DO COMPRESSOR DE AR		1	1
56118690	3460770380	JUNTA DO SUPORTE DA BOMBA INJETORA	2	2	
56118990	071511040017	JUNTA DO TUBO DE VENTILAÇÃO		1	1
56119090		JUNTA DA CARÇA DA BOMBA INJETORA	6	6	
56119190	3030180079	JUNTA DA BOMBA DE ÓLEO		1	1
56119290	0000911280	JUNTA DA FLANGE DA BOMBA ALIMENTADORA		1	1
56120190	071511026003	JUNTA DA TAMPA DA BOMBA DE ÓLEO		1	1
56133590	3460180080	JUNTA DO TUBO DE ENCHIMENTO DE ÓLEO		1	1
60012500		KIT DE ARRUELAS 6 CILINDROS		1	1
83721017		KIT DE JUNTAS DA TURBINA		1	1
86100946		KIT DE BORRACHA 6 CILINDROS		1	1
86117690	0001303920	KIT DE JUNTAS DO COMPRESSOR DE AR		1	1
86130890		KIT DE JUNTAS DA REFRIGERAÇÃO DE ÁGUA	1		
86149840		KIT DE ARRUELAS E BORRACHAS JOGO SUPERIOR OM 355 / 6 CILINDROS	1		

• VENDE-SE AVULSO

MERCEDES OM 355/6 CILINDROS 24V 11.6L

APLICAÇÃO



MERCEDES CAMINHÃO 1524 1985/89 ; 1924 1974/87 ; 2624 1974/...1525 1985/90 ; 2225 1989/89 ; 929 1984/87 ; 1932/1933 1984/89 1934 1987/89 ;

MERCEDES ÔNIBUS O 355 1972/75 ; O 370 RS/O 370 RSD 1976/90 ; OH 1420 1972/86

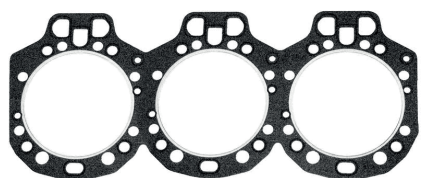

56111903 - DIÂMENTRO 133 MM

56123503 - DIÂMENTRO 133 MM

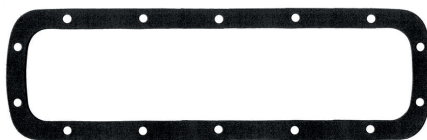

56117990



56111796



56117790



54117583

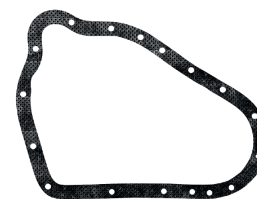

56116359



56118690



56123503

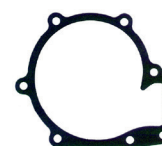

56117890



56118390



56118290

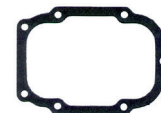

56118190



56118990



56119090



56119190



56120190



56102294



56101139



56101216



56118090



56101590



56119290



56118416



56133590



561011490



56113950



RE00269S



RE01860N



RE01815F

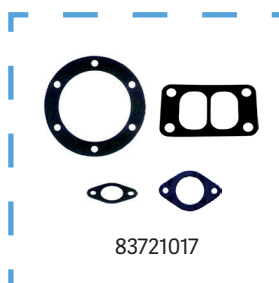
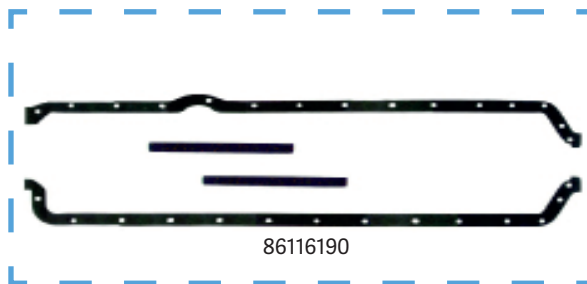
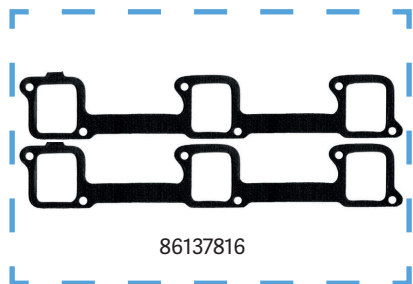

60012500		KIT DE ARRUELAS	
Nº ABR	DESCRIÇÃO		QTD
50034920	ARRUELA DE COBRE 35,3 X 41,0 X 2,0MM		7
56129723	ARRUELA DUPLA 8,0 X 12,0 X 1,0MM		6
50032729	ARRUELA DE ALUMÍNIO 30,3 X 35,9 X 1,50MM		2
50012128	ARRUELA DE ALUMÍNIO 8,3 X 13,8 X 1,0MM		18
50012928	ARRUELA DE ALUMÍNIO 8,3 X 11,4 X 1,0MM		14
50021229	ARRUELA DE ALUMÍNIO 14,0 X 20,0 X 1,5MM		14
50092728	ARRUELA DE ALUMÍNIO 12,5 X 15,9 X 1,0MM		6
50072429	ARRUELA DE ALUMÍNIO 22,5 X 26,7 X 1,5MM		6
50027329	ARRUELA DE ALUMÍNIO 20,5 X 25,9 X 1,50MM		2
50070329	ARRUELA DE ALUMÍNIO 18,5 X 21,7 X 1,5MM		2
50023329	ARRUELA DE ALUMÍNIO 16,2 X 22,0 X 1,5MM		2
50029525	ARRUELA DE ALUMÍNIO 24,2 X 29,4 X 2,0MM		2
50021429	ARRUELA DE ALUMÍNIO 14,2 X 18,0 X 1,50MM		2
50014123	ARRUELA DE COBRE 9,5 X 20,0 X 1,0MM		6

86149840		KIT DE ARRUELAS E BORRACHA DO JOGO SUPERIOR	
Nº ABR	DESCRIÇÃO		QTD
56129723	ARRUELA DUPLA 8,0 X 12,0 X 1,0 MM		6
50014123	ARRUELA DE COBRE 9,5 X 20,0 X 1,0 MM		6
50002841	ANEL DE VEDAÇÃO DO ARREFECIMENTO		6
50003041	ANEL DE VEDAÇÃO DO COLETOR DE ADMISSÃ		1

Nº JOGO	DESCRIÇÃO
76121691	445800095 JOGO DE JUNTAS COMPLETO OM 366 COM JUNTA DE CABEÇOTE 98,5MM COM RETENTORES
76111691	445800095 JOGO DE JUNTAS COMPLETO OM 366 COM JUNTA DE CABEÇOTE 100,0MM COM RETENTORES
76121701	3660100380/3308 JOGO DE JUNTAS COMPLETO OM 366A COM JUNTA DE CABEÇOTE 98,5MM COM RETENTORES
76141701	3660100380/3308 JOGO DE JUNTAS COMPLETO OM 366A COM JUNTA DE CABEÇOTE 100,0MM COM RETENTORES
761212791	JOGO DE JUNTAS COMPLETO OM 366LA COM JUNTA DE CABEÇOTE 100,0MM COM RETENTORES
76131701	JOGO DE JUNTAS SUPERIOR 366/A/LA COM JUNTA DE CABEÇOTE 98,5MM COM RETENTORES
76131691	JOGO DE JUNTAS SUPERIOR 366/A/LA COM JUNTA DE CABEÇOTE 100,0MM COM RETENTORES

Nº ABR	Nº ORIGINAL	DESCRIÇÃO	1	2	3	4	5	6	7
56149603	35201602.20	JUNTA DO CABEÇOTE OM352 / 352A / 352LA /366 / 366A / 366LA Ø 98,5 MM		1			1		1
56150201	3440167520	JUNTA DO CABEÇOTE OM352 / 352A / 352LA / 366 / 366A / 366LA Ø 100,0 MM	1		1	1		1	
56130516	3660160021	JUNTA DA TAMPA DAS VÁLVULAS	1	1	1	1	1	1	1
56131231	3661420180	JUNTA DO COLETOR DE ESCAPAMENTO	4	4	4	4	4	4	4
56131316	3661410280	JUNTA DO COLETOR DE ADMISSÃO	3	3	3	3	3	3	3
86112159	3445867001	KIT DE JUNTAS DO CÂRTER			1	1	1	1	1
56151280	3660150020	JUNTA CAIXA DISTRIBUIÇÃO OM 366 LA BOMBA "P"			1				
56170167	3660150020	JUNTA CAIXA DISTRIBUIÇÃO OM 366 LA BOMBA "A"			1				
56126598	3520150520	JUNTA DIANTEIRA DA DISTRIBUIÇÃO			1	1	1	1	1
50051167	0009979641	GAXETA (CONJUNTO COM 2 PEÇAS)			1	1	1	1	1
RE01810S		RETENTOR DIANTEIRO DO VIRABREQUIM			1	1	1	1	1
56100590	3522030680	JUNTA DO CAVALETE DE ÁGUA	2	2	2	2	2	2	2
56100890	71511022006	JUNTA DA TUBULAÇÃO DE ÁGUA			1	1	1	1	1
56102690	0000911280	JUNTA DA FLANGE DA BOMBA ALIMENTADORA			1	1	1	1	1
56106595	3120760279	JUNTA DA BOMBA INJETORA			1	1	1	1	1
56106794	3124921080	JUNTA DA CAMISA DO COMPRESSOR - IMPORTADO			1	1	1	1	1
56109498	3522010480	JUNTA DA CARÇAÇA DA BOMBA DE ÁGUA			1	1	1	1	1
56110450	3120150680	JUNTA DA TAMPA DA DISTRIBUIÇÃO			1	1	1	1	1
56114190	3141840379	JUNTA DA FLANGE DO FILTRO DE ÓLEO			1	1	1	1	1
56127695	3141840179	JUNTA DO FILTRO DE ÓLEO			1	1	1	1	1
56128416	3521310380	JUNTA DO CABEÇOTE DO COMPRESSOR (MODERNO) 94,0 MM			1	1	1	1	1
56129490	3662030080	JUNTA DO TERMOSTATO	1	1	1	1	1	1	1
56129532	3622010080	JUNTA DA BOMBA DE ÁGUA			1	1	1	1	1
56130616	3504920080	JUNTA DA SAÍDA DO ESCAPAMENTO			1	1	1	1	1
56130990	3440160080	JUNTA DA FLANGE DE ASPIRAÇÃO DA TAMPA DAS VÁLVULAS			1	1	1	1	1
56131141	3520150160	JUNTA DA TAMPA LATERAL DAS VÁLVULAS			1	1	1	1	1
56133590	3460180080	JUNTA DO TUBO DE ENCHIMENTO DE ÓLEO			1	1	1	1	1
56134894	3430150080	JUNTA TRASEIRA DA DISTRIBUIÇÃO			1	1	1	1	1
56138294	3622010180	JUNTA DO SUPORTE DA BOMBA DE ÁGUA			1	1	1	1	1
56139398	3521310380	JUNTA DO CABEÇOTE DO COMPRESSOR DE AR			1	1	1	1	1
56143990	3520180980	JUNTA DO MEDIDOR DA VARETA DO ÓLEO			1	1	1	1	1
56148390		JUNTA DO REFRIGERADOR DE ÓLEO			2	2	2	2	2
56149198	3030180079	JUNTA DO MEDIDOR DA VARETA DO ÓLEO			1	1	1	1	1
60011720		KIT DE ARRUELAS			1	1	1	1	1
86120831		KIT DE JUNTAS DA TURBINA			1	1	1		
86126675	3621800079	KIT DE JUNTAS DO RADIADOR DE ÓLEO			1	1	1	1	1
86148940		KIT DE BORRACHAS			1	1	1	1	1
86149740		KIT DE ARRUELAS E BORRACHAS DO JOGO SUPERIOR	1	1					

• VENDE-SE AVULSO

APLICAÇÃO



MERCEDES 366 CAMINHÃO 2217 1987/90 ; 1314/2216 1987/89 ; 1214 1989/96 ; 1714 1991/96 ; 1414/1614 1989/96 ; 2214 1987/89 2314 1990/94 ;

MERCEDES 366A CAMINHÃO 1218 1989/00 ; 1318 1989/03 ; 1118 1987/90 ; 2318/2418 1990/99 ; 1718 1991/99 ; 1618 1981/96 ; 1418 1989/00

MERCEDES 366LA CAMINHÃO 1721 1991/98 ; 1621 1987/97 ; 1420 2002/05 ; 1720 1997/06 ; 1723 1997/01 ; 1620 1993/05

MERCEDES 366 ÔNIBUS OF 1315 1988/94 ; O 371 ST 1988/94 ; OH 1315 1988/95 ; OF 1115 1988/92

MERCEDES 366A ÔNIBUS O 371 U 1987/94 ; OF 1618 1992/94 ; OH 1318 1988/97 ; OF 1318 1988/07 ; OF 1620 1995/99 ;

OF 1721 1998/05 OH 1420 1998/03 ; OH 1420 1998/03 ; O 371 UL 1994/97 ; OH 1421/OH 1521/OH 1623 LG 1998/04 ; OH 1621/L/LE 1997/05

MERCEDES OM 366 CILINDROS 6.0L /366A/366LA 6 CILINDROS 6.0L TURBO

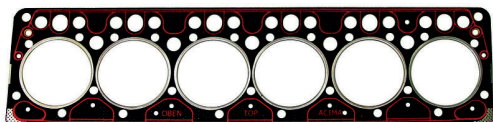

56149603-DIÂMETRO 98.5MM

56150201-DIÂMETRO 100 MM



56130516



56131141



56106595



56109498

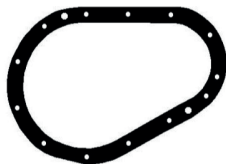

56126598



56151280



56170167



56134894



56130616



56131231



56131316



56143990



56148390



56149198



56100590



58130990



56102690



56128416



56139398



56106794



56110450



56133590



56114190



56127695



56138294



56129490

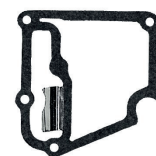

56129532



RE01810S



50051167

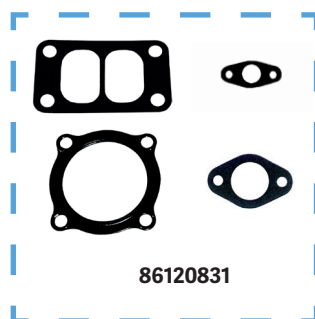
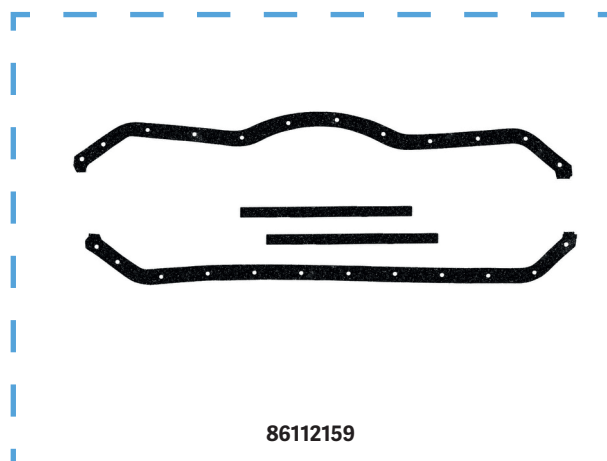
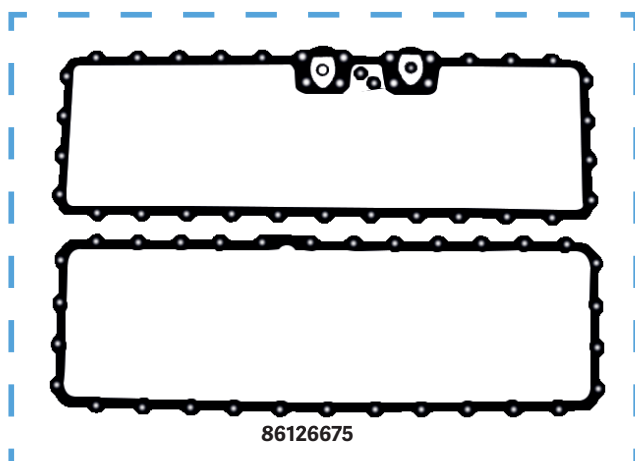

86149740 KIT DE ARRUELAS E BORRACHA DO JOGO SUPERIOR			
Nº ABR	DESCRIÇÃO	QTD	
50014123	ARRUELA DUPLA 8,0 X 12,0 X 1,0MM	6	
56129723	ARRUELA DE COBRE 9,5 X 20,0 X 1,0MM	6	
50035441	ANEL DE VEDAÇÃO DO ARREFECIMENTO	7	
50035341	ANEL DE VEDAÇÃO DO COLETOR DE ADMISSÃO	6	

60011720 KIT DE ARRUELA DO JOGO SUPERIOR			
Nº ABR	DESCRIÇÃO	QTD	
	ARRUELA DE ALUMÍNIO 26,2 X 32,0 X 1,5MM	1	
50011238	ARRUELA DE AÇO 8,0 X 12,0 X 1,0MM	16	
50011438	ARRUELA DE ALUMÍNIO 8,1 X 13,8 X 1,0MM	6	
50013860	ARRUELA DE FIBRA 9,0 X 18,0 X 0,4MM	4	
50014123	ARRUELA DE COBRE 9,5 X 20,0 X 1,0MM	6	
50015428	ARRUELA DE ALUMÍNIO 10,2 X 14,0 X 1,0MM	6	
50021129	ARRUELA DE ALUMÍNIO 14,0 X 18,0 X 1,5MM	1	
50021229	ARRUELA DE ALUMÍNIO 14,0 X 20,0 X 1,5MM	18	
50023329	ARRUELA DE ALUMÍNIO 16,2 X 22,0 X 1,5MM	6	
50025424	ARRUELA DE COBRE 18,3 X 23,8 X 1,5MM	2	
	ARRUELA DE ALUMÍNIO 24,3 X 30,0 X 1,5MM	1	
50030425	ARRUELA DE ALUMÍNIO 26,0 X 32,0 X 2,0MM	1	
50069229	ARRUELA DE ALUMÍNIO 18,2 X 21,9 X 1,5MM	3	
50072429	ARRUELA DE ALUMÍNIO 22,5 X 26,7 X 1,5MM	1	
56129723	ARRUELA DUPLA 8,0 X 12,0 X 1,0MM	6	

86148940 KIT DE BORRACHAS			
Nº ABR	DESCRIÇÃO	QTD	
	ANEL BORRACHA 30,8 X 3,7MM	6	
	ANEL BORRACHA 34,0 X 4,0MM	2	
	ANEL BORRACHA 8,3 X 2,5MM	4	
	ANEL BORRACHA 60 X 4,2MM	1	
	ANEL BORRACHA 45,0 X 4,0MM	2	
	ANEL BORRACHA 13,1 X 2,6MM	1	
	ANEL BORRACHA 28,5 X 2,5MM	1	
	ANEL BORRACHA 62,0 X 3,0MM	1	
	ANEL BORRACHA 75,0 X 3,0MM	1	
	ANEL BORRACHA 101,0 X 4,3MM	2	
	ANEL BORRACHA 14,0 X 7,5MM	7	
	ANEL BORRACHA 14,0 X 23,7 X 6,3MM	1	

Nº JOGO	DESCRIÇÃO
76196115	JOGO DE JUNTAS COMPLETO OM 447A/447LA 6 CIL COM ANÉIS DE CAMISAS COM RETENTORES
66196115	JOGO DE JUNTAS COMPLETO OM 447A/447LA 6 CIL COM ANÉIS DE CAMISAS SEM RETENTORES
76196125	JOGO DE JUNTAS COMPLETO OM 449A/449LA 5 CIL COM ANÉIS DE CAMISAS COM RETENTORES
66196125	JOGO DE JUNTAS COMPLETO OM 449A/449LA 5 CIL COM ANÉIS DE CAMISAS SEM RETENTORES
76136125	JOGO DE JUNTAS MONOCILÍNDRICO OM447 / OM449 COM RETENTORES DE HASTES DE VÁLVULAS
66136125	JOGO DE JUNTAS MONOCILÍNDRICO OM447 / OM449 SEM RETENTORES DE HASTES DE VÁLVULAS

Nº ABR	Nº ORIGINAL	DESCRIÇÃO	1	2	3	4	5	6
56137200	4220160420	JUNTA DO CABEÇOTE OM447 / OM449	1	1	5	5	6	6
56130490		JUNTA DA TAMPA DAS VÁLVULAS	1	1	5	5	6	6
56139239	4031420380	JUNTA DO COLETOR DE ESCAPAMENTO	1	1	5	5	6	6
56141317		JUNTA DO COLETOR DE ADMISSÃO	1	1	5	5	6	6
56151067	4050140222	JUNTA DO CÂRTER OM449 - 5 CILINDROS			1	1		
56151167	4070140222	JUNTA DO CÂRTER OM447 - 6 CILINDROS					1	1
56132298	4030110080	JUNTA DA TAMPA DIANTEIRA DO BLOCO			1	1	1	1
56142398	4290150080	JUNTA DA TAMPA DA DISTRIBUIÇÃO					1	1
RE02697F		RETENTOR TRASEIRO DO VIRABREQUIM					1	1
RE02696F		RETENTOR DIANTEIRO DO VIRABREQUIM					1	1
RE02786F		RETENTOR DA HASTE DAS VÁLVULAS		2		10		12
50014123	3460170160	ARRUELA DO BICO INJETOR	1	1	5	5	6	6
54308398	623208520044	JUNTA DA SAÍDA DO ÓLEO			1	1	1	1
54308490	623208520064	JUNTA DA ENTRADA DO ÓLEO			1	1	1	1
56128690	4030180180	JUNTA DA TAMPA DE ABASTECIMENTO DO ÓLEO DO CÂRTER			1	1	1	1
56129890	4750980180	JUNTA DO TUBO DO COLETOR DE ADMISSÃO DE AR			1	1	1	1
56130290	4750880280	JUNTA DO TUBO DO COLETOR DE ADMISSÃO DE AR			1	1	1	1
56130390	4422010480	JUNTA DA BOMBA DE ÁGUA			1	1	1	1
56130616	3504920080	JUNTA DA SAÍDA ESCAPAMENTO			1	1	1	1
56132490	4031840280	JUNTA DO CABEÇOTE DO FILTRO DE ÓLEO			1	1	1	1
56132590	4032011080	JUNTA DA BOMBA DE ÁGUA			1	1	1	1
56132690	917003040003	JUNTA DA FLANGE DA CONEXÃO DE AQUECIMENTO			1	1	1	1
56132795	917003036002	JUNTA DA PENEIRA DA BOMBA DE ÓLEO			1	1	1	1
56132950	4750150180	JUNTA DA TAMPA DE INSPEÇÃO			1	1	1	1
56141095	4031310780	JUNTA INFERIOR DA CARÇAÇA DO COMPRESSOR DE AR			1	1	1	1
56142490	917003026000	JUNTA DA REFRIGERAÇÃO DO ÓLEO DO CABEÇOTE			2	2	2	2
56145416	4071310780	JUNTA DA VÁLVULA DO CABEÇOTE DO COMPRESSOR DE AR			1	1	1	1
56164640	39975750	PLUG DO BICO INJETOR	1	1	5	5	6	6
56167940		ANEL CAMISA 144X3,8MM	2	2	10	10	12	12
59651490	4071310880	JUNTA DO CABEÇOTE DO COMPRESSOR DE AR			1	1	1	1
60086110		KIT DE ARRUELAS			1	1	1	1
86149032		KIT DOS ANÉIS DAS CAMISAS			5	5	6	6

• VENDE-SE AVULSO

APLICAÇÃO



MERCEDES CAMINHÃO OM 449A/449LA 5 CIL - 1630 1990/99 ; 1632 1999/02 ; 1625 1989/96 ; 2225 1987/90 ; 2325 1989/00
 MERCEDES CAMINHÃO OM 447A/447LA 6 CIL - 1634 2001/05 ; 1934 1984/91 ; 2635 1992/99 ; 1941 1989/97 ; 1935 1989/99 ; 2638/2038 1996/98
 MERCEDES ÔNIBUS OM 449A/449LA 5 CIL - O 371 R 1992/97 ; O 371 UP 1990/97 ; O 400 R 1994/97 ; O 400 UP 1995/97 ; O 400 UPA 1995/98 OH 1625/OH 1630 1990/95 ; OH 1628 1998/04
 MERCEDES ÔNIBUS OM 447A/447LA 6 CIL - O 371 RS/O 371 RSD 1990/98 ; O400 RSL/RSD 1994/99 ; O400 RS 1994/03 ; O 400 RSE/O 371 RSE 1997/99 ; OH 1625/OH 1636 1994/95

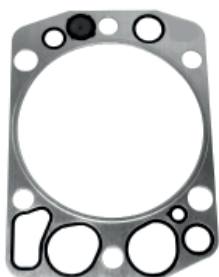

56137200

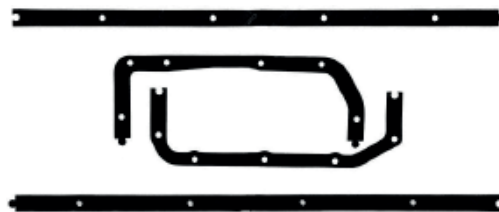

56151067

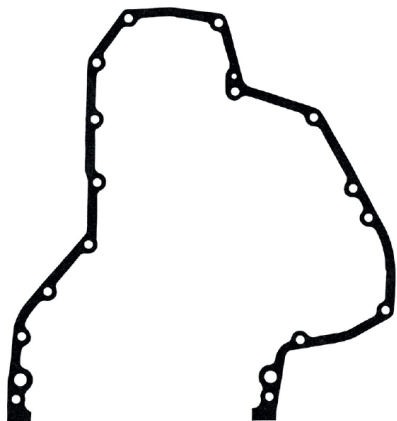

56142398



56151167



56132298

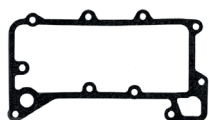

56132490



56129890



56130490



59651490



56130616



56139239



56130290



56141317



56132950



56132795



56128690



56132690



56142490



54308490



54308398



56128690



56141095



56145416



56132590



56164640



56130390



50014123

86149032		KIT DE ANÉIS DE CAMISA	
Nº ABR	DESCRIÇÃO	QTD	
56141119	ANEL TOMBAK 147,3X153,3X0,15MM	1	
56167840	VEDADOR DE BORRACHA 140,0 X 1,8 MM	1	
56167940	VEDADOR DE BORRACHA 144,0 X 3,8 MM	2	

60086116		KIT DE ARRUELAS	
Nº ABR	DESCRIÇÃO	QTD	
50023729	ARRUELA DE ALUMÍNIO 16,3 X 21,6 X 1,5MM	1	
50021429	ARRUELA DE ALUMÍNIO 14,2X18,0X1,50MM	4	
50032729	ARRUELA DE COBRE 18,3 X 22,2 X 1,50MM	1	
50023624	ARRUELA DE COBRE 16,3 X 19,8 X 1,50MM	2	
50072424	ARRUELA DE COBRE 22,5 X 26,7 X 1,50MM	1	
50029520	ARRUELA DE COBRE 24,2 X 29,4 X 2,0MM	1	
50030720	ARRUELA DE COBRE 26,3 X 30,9 X 2,00MM	1	
50014123	ARRUELA DE COBRE 9,5 X 20,0 X 1,0MM	6	

MERCEDES OM 457LA 6 CILINDROS / 12L 24V ATÉ MOTOR 32558 (CABEÇOTE SEM REBAIXO) EURO 3

Nº JOGO		DESCRIÇÃO						
66114611	JOGO DE JUNTAS COMPLETO OM 457LA 6 CILINDROS ATÉ MOTOR 32558 SEM ANÉIS DE CAMISAS SEM RETENTORES		1					
76114611	JOGO DE JUNTAS COMPLETO OM 457LA 6 CILINDROS ATÉ MOTOR 32558 SEM ANÉIS DE CAMISAS COM RETENTORES		2					
76114619	JOGO DE JUNTAS COMPLETO OM 457LA 6 CILINDROS ATÉ MOTOR 32558 COM ANÉIS DE CAMISAS COM RETENTORES		3					
66134611	JOGO DE JUNTAS MONOCILÍNDRICO OM 457LA 6 CILINDROS ATÉ MOTOR 32558 SEM ANÉIS DE CAMISAS SEM RETENTORES		4					
76134611	JOGO DE JUNTAS MONOCILÍNDRICO OM 457LA 6 CILINDROS ATÉ MOTOR 32558 SEM ANÉIS DE CAMISAS COM RETENTORES		5					
76134619	JOGO DE JUNTAS MONOCILÍNDRICO OM 457LA 6 CILINDROS ATÉ MOTOR 32558 COM ANÉIS DE CAMISAS COM RETENTORES		6					
Nº ABR	Nº ORIGINAL	DESCRIÇÃO						
56169405	4570161120	JUNTA DO CABEÇOTE OM 457 6 CILINDROS	1	1	1	6	6	6
56164967	4570160021	JUNTA DA TAMPA DAS VÁLVULAS (ALUMÍNIO)	1	1	1	6	6	6
56165940	A4570160221	JUNTA DA TAMPA DAS VÁLVULAS (PLÁSTICA)	1	1	1	6	6	6
56165716	4571410080	JUNTA DO COLETOR DE ADMISSÃO (HTM-P)	1	1	1	6	6	6
56169767		JUNTA DO CÁRTER (OM457 6 CILINDROS - SECCIONADA)				1	1	1
56151167	4070140222	JUNTA DO CÁRTER (OM457 6 CILINDROS - SECCIONADA)				1	1	1
56142377	4290150080	JUNTA DA TAMPA DA DISTRIBUIÇÃO				1	1	1
56165167	4030110080	JUNTA DA TAMPA DIANTEIRA DO BLOCO				1	1	1
RE02697F		RETENTOR TRASEIRO DO VIRABREQUIM				1	1	
RE02696F		RETENTOR DIANTEIRO DO VIRABREQUIM				1	1	
RE09237F		RETENTOR DA HASTE DAS VÁLVULAS	2	2		12	12	
50011024		ARRUELA DE COBRE 7,3 X 15,3 X 2,0 MM	1	1	1			
56130390	4422010480	JUNTA DO TUBO DA BOMBA DE ÁGUA				1	1	1
56132490	4031840280	JUNTA DO CABEÇOTE DO FILTRO DE ÓLEO				1	1	1
56132950	4750150180	JUNTA DA TAMPA DE INSPEÇÃO				1	1	1
56139239	4031420380	JUNTA DO COLETOR DE ESCAPAMENTO	1	1	1	6	6	6
56141119	4420110059	CALÇO DE CAMISA 146,18 X 155,00 X 0,15MM	1	1	1	6	6	6
56142490	917003026000	JUNTA DA REFRIGERAÇÃO DO ÓLEO DO CABEÇOTE				2	2	2
56164590	A4572010080	JUNTA DA BOMBA DE ÁGUA				1	1	1
56165367	4602010080	JUNTA DA FLANGE DO ENCHIMENTO DE ÓLEO				1	1	1
56165431	4570910180	JUNTA DO ACOPLAMENTO DA BOMBA INJETORA				1	1	1
56165567	623208520044	JUNTA DA SAÍDA DO ÓLEO				1	1	1
56165667	4421870080	JUNTA DA ENTRADA DO ÓLEO				1	1	1
56166040		ANEL DE CAMISA 144.5 X 159.1 X 7,0 MM	2					
86151140		KIT DOS ANÉIS DE BORRACHA (COM ANÉIS DE CAMISA)				1		
86151240		KIT DOS ANÉIS DE BORRACHA (SEM ANÉIS DE CAMISA)					1	1
86151329		KIT DE ARRUELAS				1	1	1

• VENDE-SE AVULSO

APLICAÇÃO

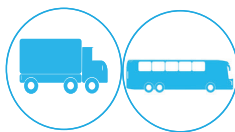

MERCEDES CAMINHÃO AXOR 1938/2638 1998/06 ; 1944 2002/05

MERCEDES ÔNIBUS O400 RSD 1998/04 ; O 400 RSE 1998/02

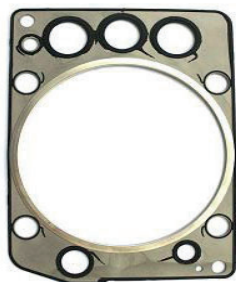

56169405

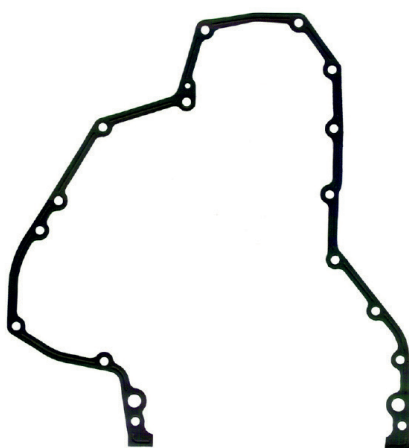

56142377



56164509



56151167

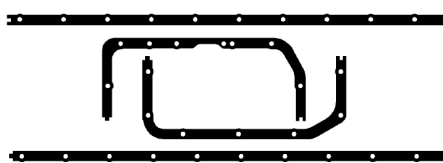

56169767

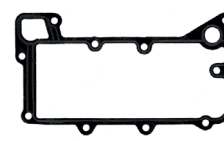

56132490



56165367



56165431



56139239



56165716



56130390



56142490



56165667



56165567



56164967



56165940



56166040



56141119



RE02696F



RE02697F



50011024



RE09237F



56165167

86151140 KIT BORRACHA OM 457		
Nº ABR	DESCRIÇÃO	QTD
56166040	ANEL DE CAMISA 144,5X159,1X7,0MM	12
50037341	VEDADOR 15,0 X 2,5MM	1
50011741	VEDADOR 57,0 X 3,5MM	1
54388340	VEDADOR 82,15 X 3,5MM	1
	VEDADOR 79,85 X 3,0MM	2

86151240 KIT DOS ANÉIS DE BORRACHA SEM ANÉIS DE CAMISA		
Nº ABR	DESCRIÇÃO	QTD
50037341	VEDADOR 15,0 X 2,5MM	1
50011741	VEDADOR 57,0 X 3,5MM	1
54388340	VEDADOR 82,15 X 3,5MM	1
	VEDADOR 79,85 X 3,0MM	2

86151329 KIT DE ARRUELAS OM 457			
Nº ABR	DESCRIÇÃO		QTD
50023624	ARRUELA DE COBRE 16,3 X 19,8 X 1,50MM		2
50072424	ARRUELA DE COBRE 22,5 X 26,7 X 1,50MM		1
50030420	ARRUELA DE COBRE 26,0 X 32,0 X 2,00MM		1
	ARRUELA DE COBRE 26,3 X 31,7 X 3,00MM		1
50022224	ARRUELA DE COBRE 14,6 X 20,8 X 1,50MM		3
50022229	ARRUELA DE ALUMÍNIO 14,6 X 20,8 X 1,5MM		1
50029720	ARRUELA DE COBRE 24,5 X 28,8 X 2,00MM		2
50011023	ARRUELA DE COBRE 7,2 X 15,2 X 1,50MM		6

Nº JOGO	DESCRIÇÃO
66114631	JOGO DE JUNTAS COMPLETO OM 457LA 6 CILINDROS APÓS MOTOR 32559 SEM ANÉIS DE CAMISAS SEM RETENTORES 1
76114631	JOGO DE JUNTAS COMPLETO OM 457LA 6 CILINDROS APÓS MOTOR 32559 SEM ANÉIS DE CAMISAS COM RETENTORES 2
76114639	JOGO DE JUNTAS COMPLETO OM 457LA 6 CILINDROS APÓS MOTOR 32559 COM ANÉIS DE CAMISAS COM RETENTORES 3
76134599	JOGO DE JUNTAS MONOCILÍNDRICO OM 457LA 6 CILINDROS APÓS MOTOR 32559 COM ANÉIS DE CAMISAS COM RETENTORES 4
76134609	JOGO DE JUNTAS MONOCILÍNDRICO OM 457LA 6 CILINDROS APÓS MOTOR 32559 COM ANÉIS DE CAMISAS COM RETENTORES 5

Nº ABR	Nº ORIGINAL	DESCRIÇÃO					
56165005	4570161220	JUNTA DO CABEÇOTE OM 457 6 CILINDROS	1	1	6	6	6
56164967	4570160021	JUNTA DA TAMPA DAS VÁLVULAS (ALUMÍNIO)	1	1	6	6	6
56165940	4570160221	JUNTA DA TAMPA DAS VÁLVULAS (PLÁSTICA)		1	6	6	6
56139239	4031420380	JUNTA DO COLETOR DE ESCAPAMENTO	1		6	6	6
56168030	5411420380	JUNTA DO COLETOR DE ESCAPAMENTO		1	6	6	6
56160530	4570980180	JUNTA DO COLETOR DE ADMISSÃO	1	1	6	6	6
56165716	4571410080	JUNTA DO COLETOR DE ADMISSÃO	1	1	6	6	6
56169767	4570140122	JUNTA DO CÂRTER (OM457 6 CILINDROS - SECCIONADA)			1	1	1
56142377	4290150080	JUNTA DA TAMPA DA DISTRIBUIÇÃO			1	1	1
56165167	5410110080	JUNTA DA TAMPA DIANTEIRA DO BLOCO			1	1	1
56178767	4570110880	JUNTA DA TAMPA DIANTEIRA DO BLOCO			1	1	1
56179067	4600110180	JUNTA DA TAMPA DIANTEIRA DO BLOCO			1	1	1
RE05155T		RETENTOR TRASEIRO DO VIRABREQUIM			1	1	
RE05184T		RETENTOR DIANTEIRO DO VIRABREQUIM			1	1	
RE09237F		RETENTOR DA HASTE DAS VÁLVULAS	4	4	24	24	
50011024		ARRUELA DE COBRE 7,3 X 15,3 X 2,0 MM	1	1			
56130390	4222010480	JUNTA DO TUBO DA BOMBA DE ÁGUA	1	1	1	1	1
56132490	4031840280	JUNTA DO CABEÇOTE DO FILTRO DE ÓLEO			1	1	1
56132950	475.015.01.80	JUNTA DA TAMPA DE INSPEÇÃO			1	1	1
56141119	4570110259	CALÇO DE CAMISA 146,18 X 155,00 X 0,15MM	1	1	6	6	6
56142490	9170030260	JUNTA DA REFRIGERAÇÃO DO ÓLEO DO CABEÇOTE			1	1	1
56164590	4572010080	JUNTA DA BOMBA DE ÁGUA			1	1	1
56165367	460.201.0080	JUNTA DA FLANGE DO ENCHIMENTO DE ÓLEO			1	1	1
56165431	4570810180	JUNTA DO ACOPLAMENTO DA BOMBA INJETORA					
56165567	6171870180	JUNTA DA SAÍDA DO ÓLEO			1	1	1
56165667	4421870080	JUNTA DA ENTRADA DO ÓLEO			1	1	1
56166040	4579970545	ANEL DE CAMISA 144,5 X 159,1 X 7,0 MM	2	2			
56174231	000160040	VEDADOR DA TAMPA DE VÁLVULAS			12	12	12
56178867	4570980880	JUNTA DO TUBO DE ADMISSÃO			1	1	1
56180067	4571880280	JUNTA DO CABEÇOTE DO FILTRO DE ÓLEO			1	1	1
56180850	A4570150080	JUNTA TUBO RESPIRO 457 LA EURO 5			1	1	1
86151140		KIT DOS ANÉIS DE BORRACHA (COM ANÉIS DE CAMISA)			1		
86151240		KIT DOS ANÉIS DE BORRACHA (SEM ANÉIS DE CAMISA)				1	1
86153029		KIT DE ARRUELAS			1	1	1

● VENDE-SE AVULSO

APLICAÇÃO

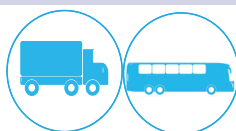

MERCEDES CAMINHÃO AXOR 1634/2640/4144 2006/12 ; 2035/2040/2044/2544/2644/3344 2005/12 ; 2535 2009/13 ; 2036 2011/... 2041/2541 2011/...2536 2012/... 2540 2004/12 ; 3340 2005/11 ; 4140 2005/11 ; 2641/3341/4141 2012/16 ; 2544/2644 2013/... 3344/4144 2013/...ATRON 1635 2012/...
 MERCEDES ÔNIBUS O 500 MA/O 500 UA/O 500 RS/O 500 RSD 2006/12 ; O 500 RSD/UDA/MDA 2013/...

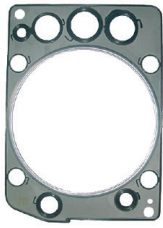

56165005



56169767

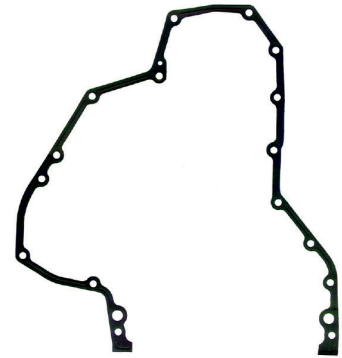

56142377



56164590



56139239



56165716



56168030



56165367



56132950



56130390



56165667



56142490



56165567



56160530



56180850



56165940



56164967



56178867



56178767



56166040



56132490

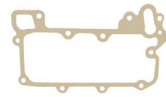

56180067



56165167



56179067

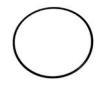

56141119



RE05184T



RE05155T



56174231



50011024



RE09237F

86151140		KIT BORRACHA OM 457	
Nº ABR	DESCRIÇÃO	QTD	
56166040	ANEL DE CAMISA 144,5X159,1X7,0MM	12	
50037341	VEDADOR 15,0 X 2,5 MM	1	
50011741	VEDADOR 57,0 X 3,5 MM	1	
54388340	VEDADOR 82,15 X 3,5 MM	1	
	VEDADOR 79,85 X 3,0 MM	2	

86151240		KIT DOS ANÉIS DE BORRACHA SEM ANÉIS DE CAMISA	
Nº ABR	DESCRIÇÃO	QTD	
50037341	VEDADOR 15,0 X 2,5 MM	1	
50011741	VEDADOR 57,0 X 3,5 MM	1	
54388340	VEDADOR 82,15 X 3,5 MM	1	
	VEDADOR 79,85 X 3,0 MM	2	

86153029		KIT DE ARRUELAS OM 457	
Nº ABR	DESCRIÇÃO	QTD	
50023624	ARRUELA DE ALUMÍNIO 16,20 X 20,00 X 1,50MM	2	
50022224	ARRUELA DE ALUMÍNIO 14,30 X 18,30 X 1,50MM	21	
50072424	ARRUELA DE ALUMÍNIO 22,30 X 26,80 X 1,50MM	1	
	ARRUELA DE ALUMÍNIO 16,20 X 22,30 X 1,50MM	20	
	ARRUELA DE ALUMÍNIO 12,10 X 16,20 X 1,50MM	12	
	ARRUELA DE ALUMÍNIO 8,20 X 12,10 X 1,00MM	30	
50011024	ARRUELA DE COBRE 7,40 X 15,00 X 1,50MM	6	
	ARRUELA DE ALUMÍNIO 26,60 X 31,50 X 2,00MM	3	
	ARRUELA DE ALUMÍNIO 24,30 X 30,30 X 1,50MM	2	

Nº JOGO		DESCRIÇÃO		
76114651		JOGO DE JUNTAS COMPLETO MERCEDES OM 611 SPRINTER 413 CDI 2.2 16V 98/ COM RETENTORES	1	
76134651		JOGO DE JUNTAS SUPERIOR MERCEDES OM 611 SPRINTER 413 CDI 2.2 16V 98/ COM RETENTORES	2	
Nº ABR	Nº ORIGINAL	DESCRIÇÃO		
56175302	6110161120	JUNTA DE CABEÇOTE	1	1
56175040	6110160121	JUNTA DA TAMPA DE VÁLVULA	1	1
56175231	6111420780	JUNTA DO COLETOR DE ESCAPE	1	1
56175131	6420140022	JUNTA DO CÂRTER		1
56175440	6110980380	JUNTA DO COLETOR DE ADMSSÃO	4	4
RE07795T	0219977647	RETENTOR DIANTEIRO		1
RE05813S	611010214	RETENTOR TRASEIRO		1
RE07927F		RETENTOR DA HASTE VÁLVULA	16	16
56174930	6112010280	JUNTA DA BOMBA DE ÁGUA		1
56176540	6112030380	JUNTA DO VEDADOR DA BOMBA DE ÁGUA	1	1
50011923		ARRUELA	4	
86152426		KIT DE ARRUELAS	1	1
86152526		KIT DE BORRACHAS		1

• VENDE-SE AVULSO

APLICAÇÃO



MERCEDES VANS SPRINTER 311/313/413 CDI 2005/12 2005/12 ; 2535 2009/13 ; 2036 2011/...

MERCEDES OM 611 4 CILINDROS 2.2L 16V ELETRÔNICO (EURO 3)



56175302

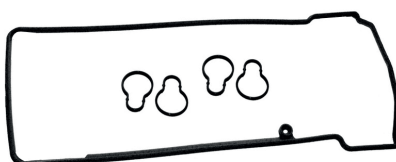

56175040

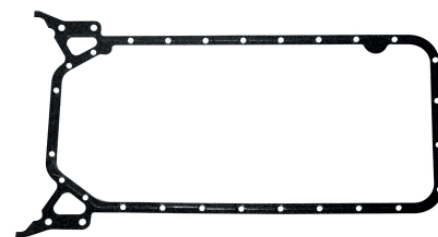

56175131



56175231



RE05813S



56176767



56176540



56175440



RE07795T



RE07927F

86151140		KIT BORRACHA OM 457	
Nº ABR	DESCRIÇÃO	QTD	
56166040	ANEL DE CAMISA 144,5 X 159,1 X 7,0MM	12	
50037341	VEDADOR 15,0 X 2,5 MM	1	
50011741	VEDADOR 57,0 X 3,5 MM	1	
54388340	VEDADOR 82,15 X 3,5 MM	1	
	VEDADOR 79,85 X 3,0 MM	2	

86152425		KIT BORRACHA OM 457	
Nº ORIGINAL	DESCRIÇÃO	QTD	
0189971948	VEDADOR 26,5 X 2,1MM	1	
1110180080	VEDADOR 47,5 X 59,0 X 2,3 MM	1	
0069977548	VEDADOR 36,5 X 2,0MM	1	
0069977648	VEDADOR 12,0 X 2,0MM	1	
1049970048	VEDADOR 10,0 X 2,0MM	1	
0229978048	VEDADOR 8,6 X 2,5MM	1	
6112030380	VEDADOR DA BOMBA DE ÁGUA	1	
6111840280	VEDADOR DO FILTRO ÓLEO	1	
6110980380	VEDADOR DO COLETOR DE ADMISSÃO	4	

MERCEDES OM 904/924 4 CILINDROS 4.25/4.8L ELETRÔNICO(EURO3/5)

Nº JOGO	Nº ORIGINAL	DESCRIÇÃO
76119041		JOGO DE JUNTAS COMPLETO OM 904 PARA TAMPA DE VÁLVULAS DE PLÁSTICO COM RETENTORES
66119041		JOGO DE JUNTAS COMPLETO OM 904 PARA TAMPA DE VÁLVULAS DE PLÁSTICO SEM RETENTORES
76119241		JOGO DE JUNTAS COMPLETO OM 924 PARA TAMPA DE VÁLVULAS DE PLÁSTICO COM RETENTORES
66119241		JOGO DE JUNTAS COMPLETO OM 924 PARA TAMPA DE VÁLVULAS DE PLÁSTICO SEM RETENTORES
76139041	9040101921	JOGO DE JUNTAS SUPERIOR OM 904 PARA TAMPA DE VÁLVULAS DE PLÁSTICO COM RETENTORES
76139241	9240101520	JOGO DE JUNTAS SUPERIOR OM 924 PARA TAMPA DE VÁLVULAS DE PLÁSTICO COM RETENTORES

Nº ABR	Nº ORIGINAL	DESCRIÇÃO						
56182005	9040161320	JUNTA DO CABEÇOTE OM 904 Ø103,7MM (NOVA)		1				1 1
56182205	924 0161120	JUNTA DO CABEÇOTE OM 924 Ø107,7MM (NOVA)	1		1	1		
56173340	0000160421	JUNTA DA TAMPA DAS VÁLVULAS (PARA TAMPA DE PLÁSTICO)	1	1	1	1	1	1
56173540	9040160721	JUNTA LATERAL DA TAMPA DAS VÁLVULAS (PARA TAMPA DE PLÁSTICO)	1	1	1	1	1	1
56175030	9061420280	JUNTA DO COLETOR DE ESCAPAMENTO	2	2	2	2	2	2
56174431	9061410180	JUNTA DO COLETOR DE ADMISSÃO	2	2	2	2	2	2
56174667	9040140622	JUNTA DO CÁRTER				1	1	1 1
RE05155T	0219975347	RETENTOR TRASEIRO DO VIRABREQUIM						1 1
RE05214T	0229977647	RETENTOR DIANTEIRO DO VIRABREQUIM						1 1
RE09284F	9060530358	RETENTOR DA HASTE DE VÁLVULA	12	12	12	12	12	12 12
56173831	9062030180	JUNTA DO TUBO DE REFRIGERAÇÃO	1	1	1	1	1	1 1
56174231	0000160040	ISOLADOR DE RUÍDO	5	5	5	5	5	5 5
56174367	9062010080	JUNTA DA BOMBA DE ÁGUA				1	1	1 1
56174867	9041880280	JUNTA DO RADIADOR DE ÓLEO				1	1	1 1
56174931	9060910380	JUNTA DA BOMBA DE COMBUSTÍVEL	1	1	1	1	1	1 1
56175840	0001883280	JUNTA RESFRIADOR DE ÓLEO	1	1	1	1	1	1 1
56179140	9041410280	JUNTA DO COLETOR DE ADMISSÃO	4	4	4	4	4	4 4
56184140		JUNTA DA TA TAMPA DE VÁLVULAS						
86173340		KIT DA TAMPA DAS VÁLVULAS (PARA TAMPA DE PLÁSTICO) COM VEDADORES						
86151626		KIT DE ARRUELAS	1	1	1	1	1	1 1
86152046		KIT DOS ANÉIS DE BORRACHA	1	1	1	1	1	1 1

• VENDE-SE AVULSO

APLICAÇÃO

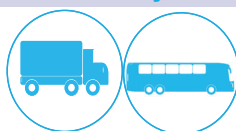

MERCEDES CAMINHÃO OM924 (COM TAMPA DE VÁLVULAS DE PLÁSTICO) 1622 2001/05 ; ACCELO 815/1016 2011/...ACCELO 1316 2015/...
ATEGO 1419 2012/...ATEGO 1719 2011/... / ATRON 1319 2012/16 ; ATRON 1719 2013/16
MERCEDES ÔNIBUS OM924 (COM TAMPA DE VÁLVULAS DE PLÁSTICO) OH 1521 1999/02 ; OH 1622L 2007/12 ; OF 1722 2001/11 ; OF 1722M 2003/12 ; OF 1721/OF 1721L 2004/... OH 1621L 2013/...VOLARE ÔNIBUS W9 FLY/DW9 FLY 2012/14
MERCEDES CAMINHÃO OM904 (MERCEDES CAMINHÃO OM904 COM TAMPA DE VÁLVULAS DE PLÁSTICO) 1215C 1999/04 ; 914C 1999/03 ; 1718 2000/12 ; 1318 2003/12 ; 1218 2001/04 ; 1418 2001/03 ATEGO 1418 2004/12 ; ATEGO 1315 2005/10 ; ATEGO 1518/1718 2005/12 ; ACCELO 915C 2002/12
MERCEDES ÔNIBUS OM904 (MERCEDES CAMINHÃO OM904 COM TAMPA DE VÁLVULAS DE PLÁSTICO) ATILIS 712E 2006/09 ;
LO 914 1999/04 ; LO 915 2003/12 ; OF 1218 2007/11 ; OF 1417 2001/06 ; OF 1418 2003/11 OH 1417 1998/05 ; OH 1418 2003/07 ; OH 1518 2006/12 ; OH 1519 2013/...

MERCEDES OM 904/924 4 CILINDROS 4.25/4.8L ELETRÔNICO(EURO3/5)

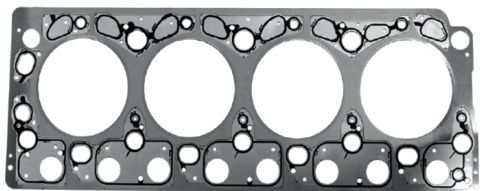

56182005 - DIÂMETRO 103,7 MM

56182205 - DIÂMETRO 107,7 MM

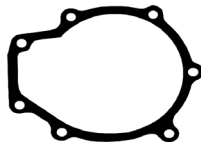

56174367

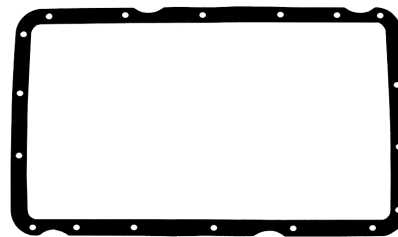

56174667

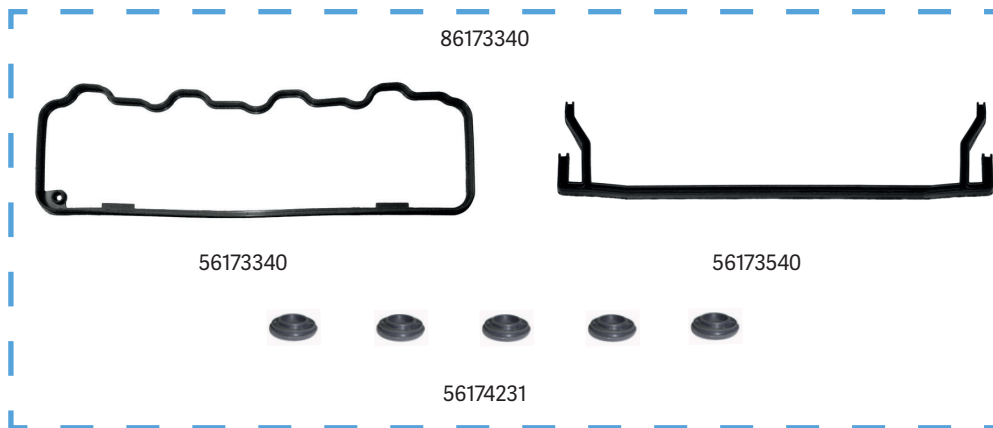

86173340

56173340

56173540

56174231

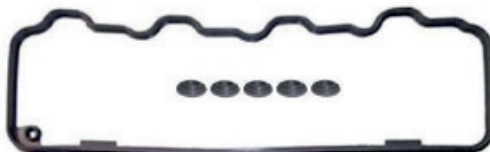

56184140



56175640



56174431



56175030

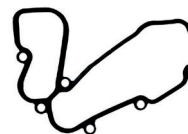

56175840



56174931



56173831



56179140



56174867



RE05155T



RE05214T



RE09284F

86151626 KIT DE ARRUELA OM 904		
Nº ABR	DESCRIÇÃO	QTD
50030420	ARRUELA DE COBRE 26,0X32,0X2,0MM	1
50027329	ARRUELA DE COBRE 20,0X26,0X1,5MM	2
50069229	ARRUELA DE COBRE 18,0X22,0X1,5MM	1
50025424	ARRUELA DE COBRE 18,0X24,0X1,5MM	1
50021524	ARRUELA DE COBRE 14,3X19,8X1,5MM	1
50021229	ARRUELA DE COBRE 14,0X20,0X1,5MM	1
50011023	ARRUELA DE COBRE 7,2X15,2X1,5MM	4

86152046 KIT DE BORRACHA OM 904			
Nº ABR	DESCRIÇÃO	QTD	
0279978348	VEDADOR 37,8X2,62MM	8	
0239976848	VEDADOR 9,0X2,5 MM	4	
5419970745	VEDADOR 25,0X3,7 MM	4	
5419970545	VEDADOR 20,9X3,0 MM	4	
5419970645	VEDADOR 11,0X3,0 MM	4	
0209971148	VEDADOR 60,0X4,2 MM	2	
0249972148	VEDADOR 118,0X3,0 MM	1	
0020941580	VEDADOR	1	
9061840280	VEDADOR DO FILTRO DE ÓLEO	1	

MERCEDES OM 906/926 6.4/7.2L ELETRÔNICO(EURO3/5)

Nº JOGO	Nº ORIGINAL	DESCRIÇÃO
76119061		JOGO DE JUNTAS COMPLETO OM 906 PARA TAMPA DE VÁLVULAS DE PLÁSTICO COM RETENTORES 1
66119061		JOGO DE JUNTAS COMPLETO OM 906 PARA TAMPA DE VÁLVULAS DE PLÁSTICO SEM RETENTORES 2
76119261		JOGO DE JUNTAS COMPLETO OM 926 PARA TAMPA DE VÁLVULAS DE PLÁSTICO COM RETENTORES 3
66119261		JOGO DE JUNTAS COMPLETO OM 926 PARA TAMPA DE VÁLVULAS DE PLÁSTICO SEM RETENTORES 4
76139061	9040101921	JOGO DE JUNTAS SUPERIOR OM 906 PARA TAMPA DE VÁLVULAS DE PLÁSTICO COM RETENTORES 5
76139261	9240101520	JOGO DE JUNTAS SUPERIOR OM 926 PARA TAMPA DE VÁLVULAS DE PLÁSTICO COM RETENTORES 6

Nº ABR	Nº ORIGINAL	DESCRIÇÃO					
56182105	9060161420	JUNTA DO CABEÇOTE OM 906 Ø103,7MM (NOVA)		1			1 1
56182305	9260161220	JUNTA DO CABEÇOTE OM 926 Ø107,7MM (NOVA)	1		1	1	
56173440	0000160521	JUNTA DA TAMPA DAS VÁLVULAS (PARA TAMPA DE PLÁSTICO)	1	1	1	1	1 1
56184040		JUNTA DA TAMPA DAS VÁLVULAS (PARA TAMPA DE PLÁSTICO) COM VENDADORES					
56173640	9060160721	JUNTA LATERAL DA TAMPA DAS VÁLVULAS (PARA TAMPA DE PLÁSTICO)	1	1	1	1	1 1
56175030	9061420280	JUNTA DO COLETOR DE ESCAPAMENTO	3	3	3	3	3 3
56174431	9061410180	JUNTA DO COLETOR DE ADMISSÃO	3	3	3	3	3 3
56174767	9060140522	JUNTA DO CÁRTER			1	1	1 1
RE05155T	219975347	RETENTOR TRASEIRO DO VIRABREQUIM				1	1
RE05214T	229977647	RETENTOR DIANTEIRO DO VIRABREQUIM				1	1
RE09284F	9060530358	RETENTOR DA HASTE DAS VÁLVULAS	18	18	18	18	18 18
56173831	9062030180	JUNTA DO TUBO DE REFRIGERAÇÃO	1	1	1	1	1 1
56174231	0000160040	ISOLADOR DE RUÍDO	7	7	7	7	7 7
56174367	9062010080	JUNTA DA BOMBA DE ÁGUA			1	1	1 1
56174567	9061880280	JUNTA DO RADIADOR DE ÓLEO			1	1	1 1
56174931	9060910380	JUNTA DA BOMBA DE COMBUSTÍVEL	1	1	1	1	1 1
56175740	1883380	JUNTA RESFRIADOR DE ÓLEO	1	1	1	1	1 1
56179140	9041410280	JUNTA DO COLETOR DE ADMISSÃO	6	6	6	6	6 6
86173440		KIT DA TAMPA DAS VÁLVULAS (PARA TAMPA DE PLÁSTICO)					
86151826		KIT DE ARRUELAS	1	1	1	1	1 1
86152146		KIT DOS ANÉIS DE BORRACHA	1	1	1	1	1 1

• VENDE-SE AVULSO

APLICAÇÃO



MERCEDES CAMINHÃO OM926 (COM TAMPA DE VÁLVULAS DE PLÁSTICO) 1728 2003/06 ; 2428 2001/06 ; ATEGO 1726/1729 2013/ ATEGO 1728/2428 2007/12 ; ATEGO 2426 2011/ ATEGO 2429 2012/15 ;
ATEGO 2430 2014/ATEGO 1730/2730/3026/3030 2016/ATRON 2324/2729 2011/16 ; AXOR 1933/2533 2005/AXOR 2831 2012/15 ; AXOR 3131 2013/
MERCEDES ÔNIBUS OM926 (COM TAMPA DE VÁLVULAS DE PLÁSTICO) O 500 M 2001/2011 ; O 500 R 2005/11 ; OF 1730 2010/12
MERCEDES CAMINHÃO OM906 (COM TAMPA DE VÁLVULAS DE PLÁSTICO) 2423 1999/09 ; 2726 2008/12 ; 1620 2006/12 ; ATEGO 1725 2009/12 ; ATEGO 2425 2005/12 ; AXOR 2826 2006/11 ;
MERCEDES ÔNIBUS OM906 (COM TAMPA DE VÁLVULAS DE PLÁSTICO) O 500 U 2013/...OH 1635 1995/99

MERCEDES OM 906/926 6.4/7.2L ELETRÔNICO(EURO3/5)

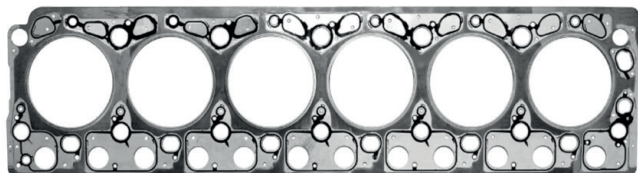

56182105 - DIÂMETRO 103,7 MM

56182305 - DIÂMETRO 107,7 MM

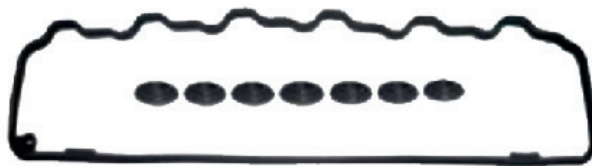

56184040

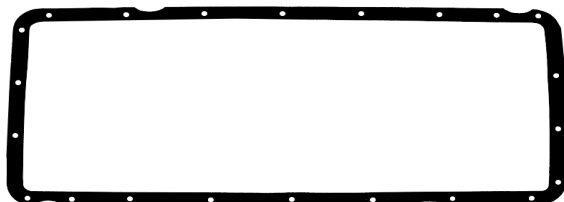

56174767

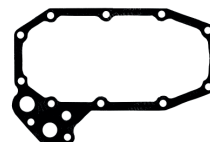

56174567

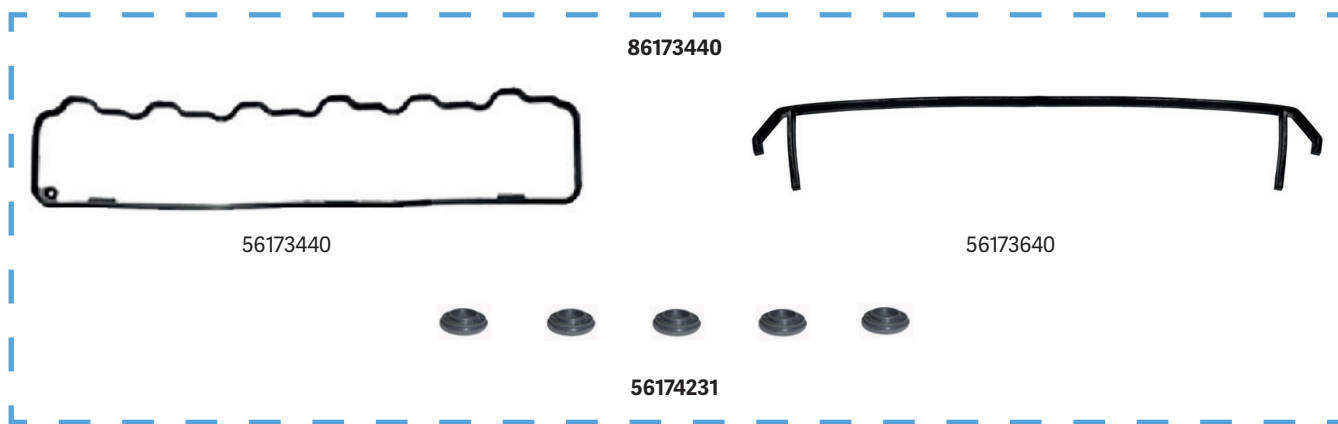

86173440

56173440

56173640

56174231

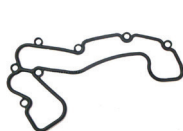

56175740



56175640



56174367



56174431



56175030



56174931



56173831



56179140



RE09284F



RE05214T



RE05155T



56174231

86151826 KIT DE ARRUELA OM 904			
Nº ABR	DESCRIÇÃO		QTD
50030420	ARRUELA DE COBRE 26,0X32,0X2,0MM		1
50027329	ARRUELA DE COBRE 20,0X26,0X1,5MM		2
50069229	ARRUELA DE ALUMÍNIO 18,0X22,0X1,5MM		1
50021524	ARRUELA DE COBRE 14,3X19,8X1,5MM		1
50023624	ARRUELA DE COBRE 16,3X19,8X1,5 MM		1
50021229	ARRUELA DE ALUMÍNIO 14,0X20,0X1,5 MM		1
50011023	ARRUELA DE OBRE 7,2X15,2X1,5 MM		6

86152146 KIT DE ARRUELA OM 904			
Nº ABR	DESCRIÇÃO		QTD
0279978348	VEDADOR 37,8X2,62MM		8
0239976848	VEDADOR 9,0X2,5MM		6
5419970745	VEDADOR 25,0X3,7MM		6
5419970545	VEDADOR 20,9X3,0MM		6
5419970645	VEDADOR 11,0X3,0MM		6
0209971148	VEDADOR 60,0X4,2MM		2
0249972148	VEDADOR 118,0X3,0MM		1
0020941580	VEDADOR		1
9061840280	VEDADOR DO FILTRO DO ÓLEO		1

MERCEDES OM 612 2.7L 20V ELETRÔNICO(EURO3)

Nº JOGO		DESCRIÇÃO			
76114682		JOGO DE JUNTAS COMPLETO MERCEDES OM 612 COM RETENTORES INCLUSIVE FLANGE TRASEIRO		1	
76134682		JOGO DE JUNTAS SUPERIOR MERCEDES OM 612 COM RETENTORES SEM FLANGE TRASEIRO		2	
Nº ABR	Nº ORIGINAL	DESCRIÇÃO			
56176002	6470161420	JUNTA DO CABEÇOTE		1	1
56176140	6120160021	JUNTA DA TAMPA DE VÁLVULA		1	1
56176230	6121410180	JUNTA DO COLETOR ADMISSÃO		1	1
56176330	6121450380	JUNTA DO COLETOR DE ESCAPE		1	1
56176430	6120140122	JUNTA DE CÁRTER			1
RE05813S	6110100214	RETETOR TRASEIRO			1
RE07795T	0219977647	RETENTOR DIANTEIRO			1
RE07927F	0000534158	RETENTOR DA HASTE DE VÁLVULA		20	20
56176630		JUNTA DO RESFRIADOR DE ÓLEO			1
56176830		JUNTA DA ENTRADA DE ÓLEO			1
56176540	6111840280	JUNTA DO FILTRO DE ÓLEO			1
56176730	6112010280	JUNTA DA BOMBA DE ÁGUA			1
86152640		KIT DE BORRACHAS		1	1
56177040	6110940080	JUNTA DE ADMISSÃO		5	5
56177140		JUNTA DO RESFRIADOR DO ÓLEO			1

• VENDE-SE AVULSO

APLICAÇÃO

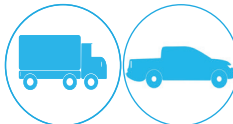

MOTOR MERCEDES OM 612 5 CILINDROS 2.7L 20V ELETRÔNICO(EURO 3)

MERCEDES CAMINHÃO ACCELO 715C DI 2002/11 ; JEEP GRAN CHEROKEE II 2001/05

MERCEDES OM 612 2.7L 20V ELETRÔNICO(EURO3)



5617002

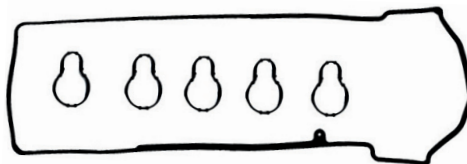

56176140

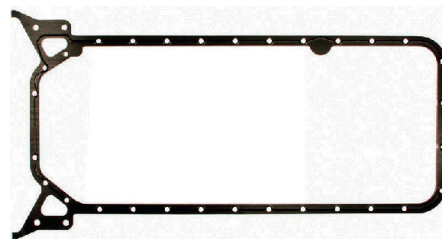

56176430

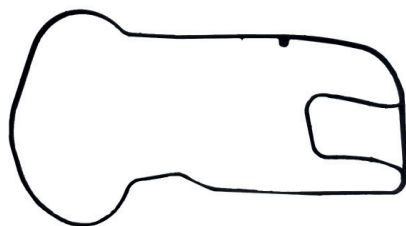

56177140

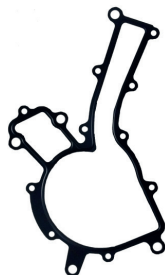

56176630



56176730



56176330



56176230



56176540



56176830



56177040



RE005813S



RE07795T



RE07927F



86152640

Nº JOGO		DESCRIÇÃO		
76112702		JOGO DE JUNAS COMPLETO DO MOTOR MERCEDES OM651 CDI COM RETENTORES	1	
76132702		JOGO DE JUNTAS SUPERIOR DO MOTOR MERCEDES OM651 CDI COM RETENTORES	2	
Nº ABR	Nº ORIGINAL	DESCRIÇÃO		
56177302	6510160220	JUNTA DO CABEÇOTE	1	1
56177240	6510160021	JUNTA DA TAMPAS DAS VÁLVULAS (ATÉ 2011)	1	1
56180940	6510160321	JUNTA DA TAMPAS DAS VÁLVULAS 2012/...	1	1
56177432	6511420580	JUNTA DO COLETOR DE ESCAPAMENTO	1	1
56177640	6510910060	JUNTA DO COLETOR DE ADMISSÃO	1	1
56177540	6510140080	JUNTA DO CÂRTER		1
RE09116F	96*114*9	RETENTOR TRASEIRO DO VIRABREQUIM		1
RE09115F	69*75*7.5/8.5	RETENTOR DIANTEIRO DO VIRABREQUIM		1
RE09203F	5*8.5*9.5	RETENTOR DA HASTE DAS VÁLVULAS	16	16
56177730		JUNTA DO TUBO DE ESCAPE	1	1
56177830	6510961180	JUNTA DA TAMPAS TRASEIRA DO CABECOTE	1	1
56177918	651422680	JUNTA DA VÁLVULA EGR	1	1
56178030	6510960480	JUNTA DO TURBO	1	1
56178130	6511420380	JUNTA DA VÁLVULA EGR	1	1
56178230	6511420480	JUNTA DA VÁLVULA EGR	1	1
56178330	6511421280	JUNTA DA VÁLVULA EGR	1	1
56178430	6511421380	JUNTA DA VÁLVULA EGR	1	1
56178530	6511422380	JUNTA DA VÁLVULA EGR	1	1
56178630	6510960280	JUNTA DO RETORNO ÓLEO	1	1
56181330	5612380180	JUNTA DA BOMBA DE ÓLEO	1	1
56181430	5611422480	JUNTA DO TROCADOR DE CALOR	1	1
86152740		KIT DE BORRACHAS		1
86152840		KIT DE BORRACHAS DO JOGO SUPERIOR	1	

• VENDE-SE AVULSO

APLICAÇÃO



MERCEDES OM 651 A CILINDROS 2.2L 16V ELETRÔNICO (EURO 5)

MERCEDES VANS SPRINTER 311/415/515 CDI 2012/...

MERCEDES OM651 4 CILINDROS 2.1L 16V CDI ELETRÔNICO(EURO5) 2012

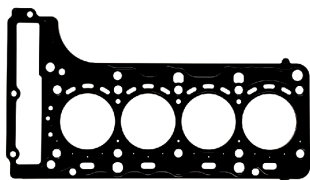

56177302

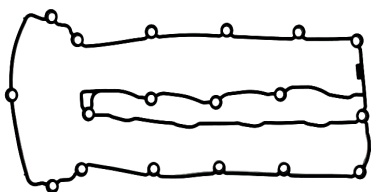

56177240

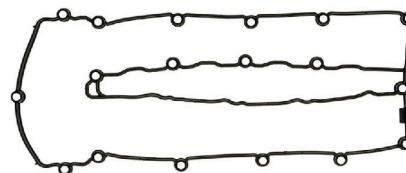

56180940

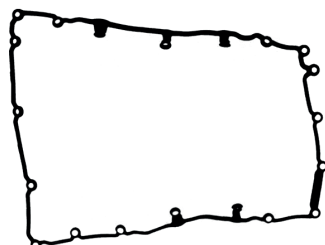

56177540



56177432



561781330



56177640



56181430



56177830



56178130



56178230



56177918



56178030



56178630



56178430



56178530



56178330



56177730



RE09116F



RE09115F



RE09203F

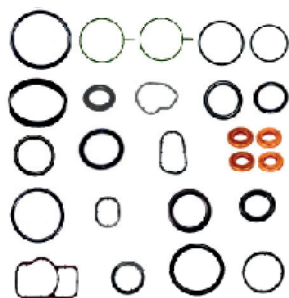

86152740

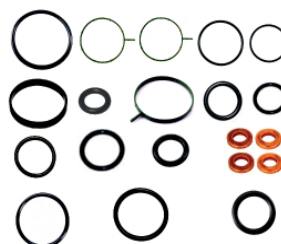

86152840

Nº JOGO	DESCRIÇÃO
76114735	JOGO DE JUNTAS COMPLETO MERCEDES OM 501(MOTOR 012091 ATÉ 084423)COM RETENTORES SEM ANEL DE CAMISA 1
76114745	JOGO DE JUNTAS COMPLETO MERCEDES OM 501(MOTOR 084424 ATÉ 155295)COM RETENTORES SEM ANEL DE CAMISA 2
76114715	JOGO DE JUNTAS COMPLETO MERCEDES OM 501(MOTOR 155296 ATÉ 377748)COM RETENTORES SEM ANEL DE CAMISA 3
76114725	JOGO DE JUNTAS COMPLETO MERCEDES OM 501(APÓS MOTOR 377749)COM RETENTORES SEM ANEL DE CAMISA 4
76134735	JOGO DE JUNTAS SUPERIOR MERCEDES OM 501/502(MOTOR 012091 ATÉ 084423)COM RETENTORES 5
76134745	JOGO DE JUNTAS SUPERIOR MERCEDES OM 501/502(MOTOR 084424 ATÉ 155295)COM RETENTORES 6
76134715	JOGO DE JUNTAS SUPERIOR MERCEDES OM 501/502(MOTOR 155296 ATÉ 377748)COM RETENTORES 7
76134725	JOGO DE JUNTAS SUPERIOR MERCEDES OM 501/502(APÓS MOTOR 377749)COM RETENTORES 8
76134730	JOGO DE JUNTAS INFERIOR MERCEDES OM 501(TODOS)COM RETENTORES SEM JUNTA DE CÁRTER 9
76134720	JOGO DE JUNTAS INFERIOR MERCEDES OM 501(ATÉ MOTOR 012090)COM RETENTORES COM JUNTA DE CÁRTER SOFT 10
76134710	JOGO DE JUNTAS INFERIOR MERCEDES OM 501(APÓS MOTOR 012091)COM RETETENORES COM JUNTA CÁRTER BORRACHA 11

Nº ABR	Nº ORIGINAL	DESCRIÇÃO													
56179205	5410161120	JUNTA DO CABEÇOTE OM501/502 (ATÉ MOTOR 377748)			1	1	1		6	6	6				
56179305	5410161320	JUNTA DO CABEÇOTE OM501/502 (APÓS MOTOR 377749)			1				6						
56165940	4570160121	JUNTA DA TAMPA VÁLVULA OM501/502(APÓS MOTOR 155296)OM			1	1			6	6					
56181040	5410160321	JUNTA DA TAMPA VÁLVULA OM501/502(ATÉ MOTOR 084423)						1			6				
56179440	5410160421	JUNTA DA TAMPA VÁLVULA OM501/502(MOTOR 084424 ATÉ 155295)						1			6				
54168030	5411420280	JUNTA DO COLETOR ESCAPE OM 501/502/457			1	1	1	1	6	6	6	6			
56179730	5410980480	JUNTA DO COLETOR ADMISSÃO OM 501/502			1	1	1	1	6	6	6	6			
56179540	5410140722	JUNTA DO CÁRTER DE BORRACHA OM502(APÓS MOTOR 012091)	1						1	1	1	1			
56179867	5410140322	JUNTA DO CÁRTER SOFT OM502(ATÉ MOTOR 012090)		1											
56180430	5410151180	JUNTA DA TAMPA FRONTAL - ESQUERDA	1	1	1				1	1	1	1			
56180530	5410151280	JUNTA DA TAMPA FRONTAL - DIREITA	1	1	1				1	1	1	1			
56180340	5410151380	JUNTA DA TAMPA DISTRIBUIÇÃO	1	1	1				1	1	1	1			
56180740	5410150160	JUNTA DA TAMPA DISTRIBUIÇÃO	1	1	1				1	1	1	1			
RE02697T	139971447	RETENTOR TRASEIRO DO VIRABREQUIM MBB OM457/501/502	1	1	1				1	1	1	1			
RE02696T	149974647	RETENTOR DIANTEIRO DO VIRABREQUIM MBB OM457/501/502	1	1	1				1	1	1	1			
RE09237F	533558	RETENTOR DA HASTE DAS VÁLVULAS OM457/501/502						4	4	4	4	24	24	24	24
56132267	5410110080	JUNTA DA TAMPA TRASEIRA	1	1	1				1	1	1	1			
56141030	5411310780	JUNTA DO COMPRESSOR	2	2	2				2	2	2	2			
56169300	9425010080	JUNTA DO TUBO DA ENTRADA DA BOMBA DE ÁGUA	1	1	1				1	1	1	1			
56180130	5422010180	JUNTA DA BOMBA DE ÁGUA	1	1	1				1	1	1	1			
56180230	5411840980	JUNTA DO RESFRIADOR DO ÓLEO	1	1	1				1	1	1	1			
56180630	5422010180	JUNTA DA CONEXAO DA BOMBA DE ÁGUA	1	1	1				1	1	1	1			
56181132	5410110459	CALÇO DE CAMISA 0,15MM	6	6	6				6	6	6	6			
86153140		KIT DE BORRACHAS E ARRUELAS	1	1	1				1	1	1	1			

• VENDE-SE AVULSO

APLICAÇÃO



MERCEDES CAMINHÃO ACTROS 2646S 2010/... 2546S 2011/... 4844K 2008/17 4144K 2008/...

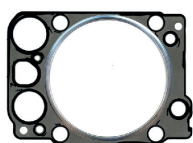

56179205

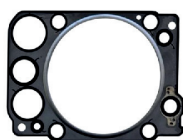

56179305



56179540

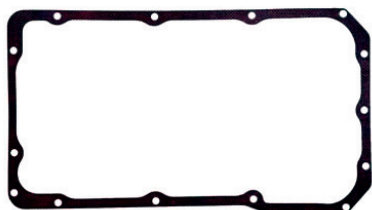

56179867



56180740



56180340

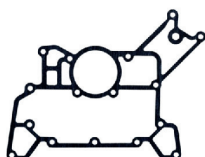

56180230

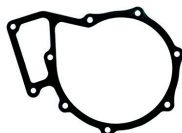

56177040



56180430



56180530



56132298



56181040



56179440



56165940



56141030



56179730



56180630



56169300



56168030



RE02697T



RE02696T



56181132



RE09237F



86153140

Nº JOGO	DESCRIÇÃO
76114755	JOGO DE JUNTAS COMPLETO MERCEDES OM 502(MOTOR 012091 ATÉ 084423)COM RETENORES SEM ANEL DE CAMISA 1
76114765	JOGO DE JUNTAS COMPLETO MERCEDES OM 502(MOTOR 084424 ATÉ 155295)COM RETENORES SEM ANEL DE CAMISA 2
76114775	JOGO DE JUNTAS COMPLETO MERCEDES OM 502(MOTOR 155296 ATÉ 377748)COM RETENORES SEM ANEL DE CAMISA 3
76114785	JOGO DE JUNTAS COMPLETO MERCEDES OM 502(APÓS MOTOR 377749)COM RETENORES SEM ANEL DE CAMISA 4
76134735	JOGO DE JUNTAS SUPERIOR MERCEDES OM 501/502(MOTOR 012091 ATÉ 084423)COM RETENORES 5
76134745	JOGO DE JUNTAS SUPERIOR MERCEDES OM 501/502(MOTOR 084424 ATÉ 155295)COM RETENORES 6
76134715	JOGO DE JUNTAS SUPERIOR MERCEDES OM 501/502(MOTOR 155296 ATÉ 377748)COM RETENORES 7
76134725	JOGO DE JUNTAS SUPERIOR MERCEDES OM 501/502(APÓS MOTOR 377749)COM RETENORES 8
76134760	JOGO DE JUNTAS INFERIOR MERCEDES OM 502(TODOS)COM RETENORES SEM JUNTA DE CÂRTER 9
76134750	JOGO DE JUNTAS INFERIOR MERCEDES OM 502(ATÉ MOTOR 012090)COM RETENORES COM JUNTA DE CÂRTER SOFT 10
76134740	JOGO DE JUNTAS INFERIOR MERCEDES OM 502(APÓS MOTOR 012091)COM RETENORES COM JUNTA CÂRTER BORRACHA 11

Nº ABR	Nº ORIGINAL	DESCRIÇÃO											
56179205	5410161120	JUNTA DO CABEÇOTE OM501/502 (ATÉ MOTOR 377748)				1	1	1		8	8	8	
56179305	5410161320	JUNTA DO CABEÇOTE OM501/502 (APÓS MOTOR 377749)			1				8				
56165940	4570160121	JUNTA DA TAMPA DE VÁLVULA OM501/502(APÓS MOTOR 155296)OM		1	1				8	8			
56181040	5410160321	JUNTA DA TAMPA DE VÁLVULA OM501/502(ATÉ MOTOR 084423)						1					8
56179440	5410160421	JUNTA DA TAMPA VÁLVULA OM501/502(MOTOR 084424 ATÉ 155295)						1					8
54168030	5411420280	JUNTA DO COLETOR ESCAPE OM 501/502/457		1	1	1	1	1	8	8	8	8	
56179730	5410980480	JUNTA DO COLETOR ADMISSÃO OM 501/502		1	1	1	1	1	8	8	8	8	
56179967	5410140722	JUNTA DO CÂRTER OM502(ATÉ MOTOR 012090)SOFT		1									
56179640	5410140322	JUNTA DO CÂRTER OM502(APÓS MOTOR 012091)BORRACHA	1							1	1	1	1
56180430	5410151180	JUNTA DA TAMPA FRONTAL - ESQUERDA	1	1	1					1	1	1	1
56180530	5410151280	JUNTA DA TAMPA FRONTAL - DIREITA	1	1	1					1	1	1	1
56180340	5410151380	JUNTA DA TAMPA DE DISTRIBUIÇÃO	1	1	1					1	1	1	1
56180740	5410150160	JUNTA DA TAMPA DE DISTRIBUIÇÃO	1	1	1					1	1	1	1
RE02697T	139971447	RETENTOR TRASEIRO DO VIRABREQUIM MBB OM457/501/502	1	1	1					1	1	1	1
RE02696T	149974647	RETENTOR DIANTEIRO DO VIRABREQUIM MBB OM457/501/502	1	1	1					1	1	1	1
RE09237F	533558	RETENTOR DA HASTE DAS VÁLVULAS OM457/501/502				4	4	4	4	32	32	32	32
56132267	5410110080	JUNTA DA TAMPA TRASEIRA	1	1	1					1	1	1	1
56141030	5411310780	JUNTA DO COMPRESSOR	2	2	2					2	2	2	2
56169300	9425010080	JUNTA DO TUBO DA ENTRADA DA BOMBA DE ÁGUA	1	1	1					1	1	1	1
56180130	5422010180	JUNTA DA BOMBA DE ÁGUA	1	1	1					1	1	1	1
56180230	5411840980	JUNTA DO RESFRIADOR DO ÓLEO	1	1	1					1	1	1	1
56180630	5422010180	JUNTA DA CONEXÃO DA BOMBA DE ÁGUA	1	1	1					1	1	1	1
56181132	5410110459	CALÇO DE CAMISA 0,15MM	8	8	8					8	8	8	8
86153140		KIT DE BORRACHAS E ARRUELAS	1	1	1					1	1	1	1

• VENDE-SE AVULSO

APLICAÇÃO



MERCEDES CAMINHÃO ACTROS 2655 LS 2013/16

MERCEDES OM 502LA 8 CILINDROS 16L 32V V8 EURO 5

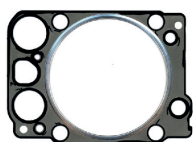

56179205

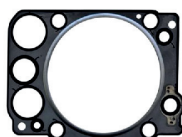

56179305



56179640

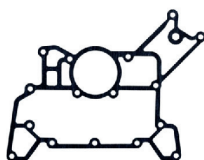

56180230



56180740



56180340



56132298

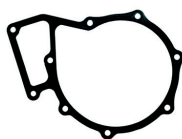

56180130



56180430



56180530



56141030



56181040



56179440



56165940



56181132



56179730



56180630



56169300



56168030



RE02697T



RE02696T



RE09237F



86153140



MWM

Nº ABR	MOTOR	DESCRIÇÃO		PÁGINA
64311871	D226	JOGO DE JUNTAS COMPLETO	SEM RETENTORES	88
74311871	D226	JOGO DE JUNTAS COMPLETO	COM RETENTORES	88
64314181	D229 4 CILINDROS	JOGO DE JUNTAS COMPLETO	SEM RETENTORES	90
74314181	D229 4 CILINDROS	JOGO DE JUNTAS COMPLETO	COM RETENTORES	90
64314193	TD229 4 CILINDROS	JOGO DE JUNTAS COMPLETO	SEM RETENTORES	90
74314193	TD229 4 CILINDROS	JOGO DE JUNTAS COMPLETO	COM RETENTORES	90
64414543	TD229 4 CILINDROS	JOGO DE JUNTAS COMPLETO	SEM RETENTORES	90
74414543	TD229 4 CILINDROS	JOGO DE JUNTAS COMPLETO	COM RETENTORES	90
64315061	X10 4 CILINDROS	JOGO DE JUNTAS COMPLETO	SEM RETENTORES	94
74315061	X10 4 CILINDROS	JOGO DE JUNTAS COMPLETO	COM RETENTORES	94
64315071	X10 6 CILINDROS	JOGO DE JUNTAS COMPLETO	SEM RETENTORES	94
74315071	X10 6 CILINDROS	JOGO DE JUNTAS COMPLETO	COM RETENTORES	94
64315032	412TCE X12 4 CILINDROS	JOGO DE JUNTAS COMPLETO	SEM RETENTORES COM ANÉIS DE CAMISA	98
74315032	412TCE X12 4 CILINDROS	JOGO DE JUNTAS COMPLETO	COM RETENTORES COM ANÉIS DE CAMISA	98
64315042	612TCE X12 6 CILINDROS	JOGO DE JUNTAS COMPLETO	SEM RETENTORES COM ANÉIS DE CAMISA	98
74315042	612TCE X12 6 CILINDROS	JOGO DE JUNTAS COMPLETO	COM RETENTORES COM ANÉIS DE CAMISA	98
64315083	4.07 TCA	JOGO DE JUNTAS COMPLETO	SEM RETENTORES	102
74315083	4.07 TCA	JOGO DE JUNTAS COMPLETO	COM RETENTORES	102
74385081	4.07 TCA	JOGO DE JUNTAS SUPERIOR	COM RETENTORES	102
64315103	4.07/4.08 TCE ELETRÔNICO	JOGO DE JUNTAS COMPLETO	SEM RETENTORES	102
74315103	4.07/4.08 TCE ELETRÔNICO	JOGO DE JUNTAS COMPLETO	COM RETENTORES	102
74335103	4.07/4.08 TCE ELETRÔNICO	JOGO DE JUNTAS SUPERIOR	COM RETENTORES	102
64315093	6.07 TCA	JOGO DE JUNTAS COMPLETO	SEM RETENTORES	106
74315093	6.07 TCA	JOGO DE JUNTAS COMPLETO	COM RETENTORES	106
64315145	MAXFORCE X12 4 CILINDROS	JOGO DE JUNTAS COMPLETO	SEM RETENTORES	110
74315145	MAXFORCE X12 4 CILINDROS	JOGO DE JUNTAS COMPLETO	COM RETENTORES	110
74335145	MAXFORCE X12 4 CILINDROS	JOGO DE JUNTAS SUPERIOR	COM RETENTORES	110
64315165	MAXFORCE X12 6 CILINDROS	JOGO DE JUNTAS COMPLETO	SEM RETENTORES	110
74315165	MAXFORCE X12 6 CILINDROS	JOGO DE JUNTAS COMPLETO	COM RETENTORES	110
74335165	MAXFORCE X12 6 CILINDROS	JOGO DE JUNTAS SUPERIOR	COM RETENTORES	110
84335465	MAXFORCE X12	JOGO DE JUNTAS MONOCILINDRICO	COM RETENTORES	110

MWM D226 4 CILINDROS 4.2 LITROS

Nº JOGO		DESCRIÇÃO		
64311871		JOGO DE JUNTAS COMPLETO MWM D226 SEM RETENTORES	1	
74311871		JOGO DE JUNTAS COMPLETO MWM D226 COM RETENTORES	2	
Nº ABR	Nº ORIGINAL	DESCRIÇÃO		
54307800	622608540034	JUNTA DO CABEÇOTE Ø106,5MM	4	4
54307652	920808530014	JUNTA DA TAMPA DAS VÁLVULAS	4	4
54307316	620708530074	JUNTA DO COLETOR DE ESCAPAMENTO	4	4
54310816	632138530094	JUNTA DA TAMPA DO COLETOR DE ADMISSÃO	4	4
54310590	630508530144	JUNTA DO CÂRTER 4 CILINDROS (SECCIONADA)	1	1
54311398	632508530184	JUNTA DA TAMPA FRONTAL DE DISTRIBUIÇÃO	1	1
RE00803S	922988560044	RETENTOR TRASEIRO DO VIRABREQUIM 110X130X13MM	1	
RE01917S	922988560034	RETENTOR DIANTEIRO DO VIRABREQUIM 78X100X13MM	1	
54307190	620508530124	JUNTA DO SUPORTE DA BOMBA INJETORA	1	1
54307290	620608530014	JUNTA DO SUPORTE DA BOMBA DE ÁGUA	1	1
54310790	030508530214	JUNTA DO FILTRO DE ÓLEO	1	1
54310990	632148530124	JUNTA DA BOMBA INJETORA	1	1
54311190	632508530054	JUNTA DA TAMPA TRASEIRA	1	1
54311290	632508530154	JUNTA DA BOMBA HIDRÁULICA	1	1
54312216	922508510014	JUNTA DA CURVA DO ESCAPAMENTO	1	1
54314090	922608530124	JUNTA DA BOMBA INJETORA	1	1
54314190	922608530134	JUNTA DA BOMBA ALIMENTADORA	2	2
54314290	922608530104	JUNTA DE FIXAÇÃO DO FILTRO DE AR	1	1
54315090	922208530134	JUNTA DA BOMBA D'ÁGUA	1	1
60011870		KIT DE ARRUELAS	1	1
84383941		KIT DE BORRACHAS	1	1
U4301567	922508530024	JUNTA DO CÂRTER - COMPLEMENTO	2	2

• VENDE-SE AVULSO

APLICAÇÃO

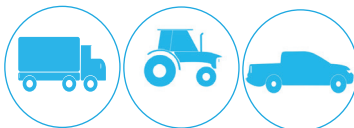

FORD PICK-UP F4000 1975/82 ; F1000 1977/79 ;

VOLKSWAGEN 6.90 1982/86 ;

MASSEY FERGUSON MF85X 1975/78 / VALTRA TRACTOR 86ID 1981/88 ; CASE TRATOR CA-875/CA-1140 1979/... ; VALTRA 86 ID 1981/88

MWM D226 4 CILINDROS 4.2 LITROS



54307800-DIÂMETRO 106,5 MM

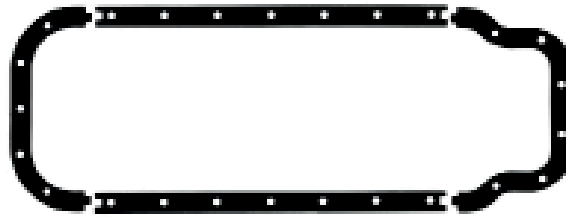

54310590



U4301567

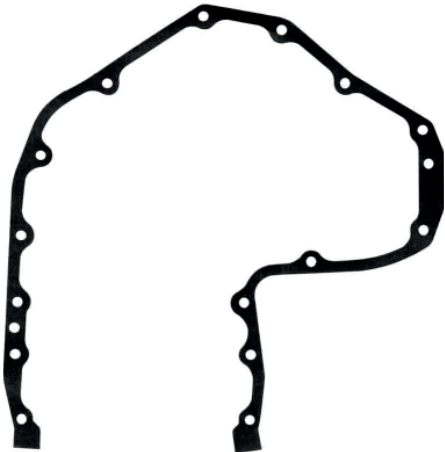

54311398

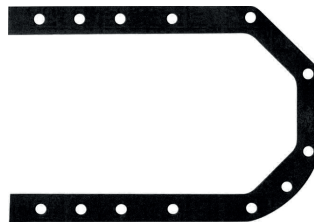

54311190



54307652



54312216



54314290



54307190

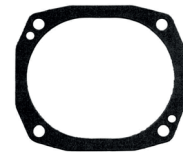

54311290



54315090



54307290



54310790



54307316



54310816



54314090



54314190



54310990



RE00803S



RE01917S

84383941		KIT DE BORRACHAS	
Nº ABR	DESCRIÇÃO	QTD	
50004741	VEDADOR 44,0X3,0 MM	1	
50005441	VEDADOR 32,0X4,0 MM	2	
50055741	VEDADOR 22,0X32,5X7,8 MM	4	
50005741	VEDADOR 20,0X4,0 MM	1	

60011870		KIT DE ARRUELAS	
Nº ABR	DESCRIÇÃO	QTD	
50021429	ARRUELA DE ALUMÍNIO 14,2X18,0X1,5 MM	11	
50012128	ARRUELA DE ALUMÍNIO 10,5X15,8X1,0 MM	14	
50012128	ARRUELA DE ALUMÍNIO 8,3X13,0X1,0 MM	2	
	ARRUELA DE ALUMÍNIO 8,3X11,8X1,0 MM	3	
50072428	ARRUELA DE ALUMÍNIO 22,5X26,7X1,0 MM	1	
50015728	ARRUELA DE ALUMÍNIO 10,2X13,9X1,0 MM	4	
50014130	ARRUELA DE AÇO 9,5X20,0X2,0 MM	4	

MWM D229 / TD229 4 CILINDROS 3.9 LITROS

Nº JOGO		DESCRIÇÃO						
64314181	JOGO DE JUNTAS COMPLETO MWM D229 4 CILINDROS ASPIRADO SEM RETENTORES		1					
74314181	JOGO DE JUNTAS COMPLETO MWM D229 4 CILINDROS ASPIRADO COM RETENTORES		2					
64314193	JOGO DE JUNTAS COMPLETO MWM TD229 4 CILINDROS TURBINADO SEM RETENTORES		3					
74314193	JOGO DE JUNTAS COMPLETO MWM TD229 4 CILINDROS TURBINADO COM RETENTORES		4					
64414543	JOGO DE JUNTAS COMPLETO VALMET TD229 4 CILINDROS TURBINADO SEM RETENTORES		5					
74414543	JOGO DE JUNTAS COMPLETO VALMET TD229 4 CILINDROS TURBINADO COM RETENTORES		6					
Nº ABR	Nº ORIGINAL	DESCRIÇÃO						
54319000	922908541044	JUNTA DO CABEÇOTE Ø110MM	4	4	4	4	4	4
54324144	922908530444	JUNTA DA TAMPA DAS VÁLVULAS (BORRACHA)	4	4	4	4		
54324156	922908530064	JUNTA DA TAMPA DAS VÁLVULAS (CORTIÇA COM BORRACHA)			4	4	4	4
54338917	922908530684	JUNTA DO COLETOR DE ESCAPAMENTO - TURBO	4	4	4	4		
54307316	922908531174	JUNTA DO COLETOR DE ADMISSÃO (ASPIRADO / TURBO) / ESCAPAMENTO (ASP.)	4	4	4	4	8	8
54310590	922908530406	JUNTA DO CÂRTER 4 CILINDROS (SECCIONADA)	1	1	1	1	1	1
84331191	922908530886	JUNTA DO CÂRTER 4 CILINDROS VALMET 980 (SECCIONADA)						
54311398	922908530674	JUNTA DA TAMPA FRONTAL	1	1	1	1	1	1
RE00803S	922988560044	RETENTOR TRASEIRO DO VIRABREQUIM 110X130X13MM	1		1		1	
RE01917S	922988560034	RETENTOR DIANTEIRO DO VIRABREQUIM 78X100X13MM	1		1		1	
50015429	604920101014	ARRUELA 10,0 X 14,0 X 1,5 MM			2			
50021229	604920101420	ARRUELA 14,0 X 20,0 X 1,5 MM			4			
52111731	3440987080	JUNTA DA MESA DA TURBINA			1			
54306545	604931041124	ANEL DE CAMISA	8	8	8	8	8	8
54307190	922988531684	JUNTA DO SUPORTE DA BOMBA INJETORA	1	1	1	1	1	1
54307290	962608530014	JUNTA DO SUPORTE DA BOMBA D'ÁGUA	1	1	1	1	1	1
54308395	961008528014	JUNTA DO TUBO DE LUBRIFICAÇÃO			1			
54308490	961008528024	JUNTA DO RETORNO DO ÓLEO DA TURBINA			1			
54310790	922908531044	JUNTA DO FILTRO DE ÓLEO	1	1	1	1	1	1
54310990	922908531124	JUNTA DA BOMBA INJETORA	1	1	1	1	1	1
54311090	922908531094	JUNTA DA FIXAÇÃO DO FILTRO DE AR	1	1	1	1	1	1
54311190	922908530664	JUNTA DA TAMPA TRASEIRA	1	1	1	1	1	1
54311290	922908530694	JUNTA DA BOMBA HIDRÁULICA	1	1	1	1	1	1
54312198	922908531284	JUNTA DA BOMBA CENTRÍFUGA	1	1	1	1	1	1
54312216	922908510024	JUNTA DA CURVA DO ESCAPAMENTO	1	1	1	1	1	1
54312798	922908530984	JUNTA DA TAMPA DA BOMBA	1	1	1	1	1	1
54314090	922908531344	JUNTA DA BOMBA INJETORA	1	1	1	1	1	1
54314190	922908531134	JUNTA DA BOMBA ALIMENTADORA	2	2	2	2	2	2
54314290	922608530104	JUNTA DE FIXAÇÃO DO FILTRO DE AR	1	1	1	1	1	1
54315090	922908530724	JUNTA DA BOMBA DE ÁGUA	1	1	1	1	1	1
54320217	922908531204	JUNTA DA SAÍDA DO ESCAPAMENTO			1	1	1	1
54322416	922908530704	JUNTA DA MESA DA TURBINA	1	1				
54328916	922908531274	JUNTA DO COLETOR DE ADMISSÃO	1	1				
54330590	922908530734	JUNTA DA BOMBA DE ÁGUA	1	1	1	1	1	1
54333517	922908531324	JUNTA DO CARACOL DA TURBINA	1	1				
54338296		JUNTA DA TURBINA			1	1		
54340090	922908530654	JUNTA DO FILTRO DO CABEÇOTE	1	1	1	1	1	1
54340290	922908531074	JUNTA DO RESFRIADOR DE ÓLEO	1	1	1	1	1	1
56121131	3520980880	JUNTA DO CARACOL DA TURBINA			1	1		
56121390	922908530094	JUNTA DA TURBINA			1	1		
60014140		KIT DE ARRUELAS	1	1	1	1	1	1
84384146		KIT DE BORRACHAS - ASPIRADO					1	1
84395246		KIT DE BORRACHA - TURBINADO	1	1	1	1		
U4311867		COMPLEMENTO JUNTA DO CARTER 4 CILINDROS VALMET 980 (SECCIONADA)	2	2				

• VENDE-SE AVULSO

MWM D229 / TD229 4 CILINDROS 3.9 LITROS

APLICAÇÃO

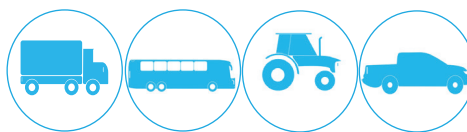

MWM D229 4 CIL ASPIRADO FORD CAMINHÃO F1000 /2000 1979/90 ; F4000 1990/92
VOLKSWAGEN CAMINHÃO 7.90S 1987/94 ; AGRALE CAMINHÃO 1800D 1988/95; 5075/5075.4/BX6110 2003/...5085/5085.4 1999/...575/575.4 2003/...565 2014/15 565.4 2013/...5060/5080 1999/...
MWM TD229 4 CILINDROS TURBINADO VW CAMINHÃO 7110S 1987/94 ; FORD PICK-UP F1000 1991/95 ; F4000 1990/92
AGRALE CAMINHÃO 4500 D 1994/97 ; 5000 D 1994/98 ; 7000 D 1993/02 ; 7500 TD 1994/05
MWM D229 4 CILINDROS ASPIRADO VW ÔNIBUS 7.90S C0 1987/92
MWM D229 4 CILINDROS ASPIRADO VALTRA TRACTOR 785 1986/08 885 1986/99 880 1985/02 78/88 1981/88
VALTRA TD229 4 CILINDROS TURBINADO AGRALE TRACTOR BX4110/BX4190 1990/98 ; BX090/BX100 1990/95
BX5105 2013/... VALTRA TRACTOR 980 1984/96 ; 985 1988/02
MWM TD229 4 CILINDROS TURBINADO FORD PICK-UP F1000 1991/95 ; F4000 1990/92

MWM D229 / TD229 4 CILINDROS 3.9 LITROS

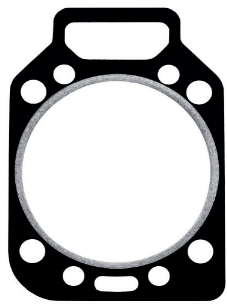

54319000



54310590



54311398

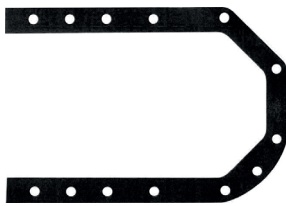

54311190

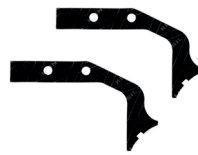

U4311867

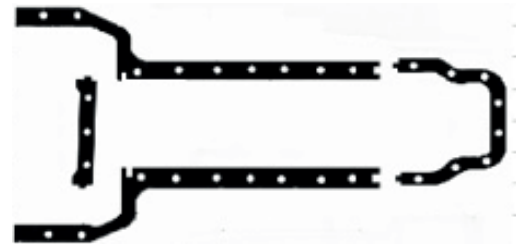

84331191



54320217



54328916



54308490



54308395



54338917



54307316



56121396



54340290



54310990



54315090



54311290



54330590



52111731



54314290



54311090



54312216



54322418



54312790

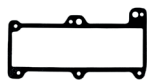

54340090



54307290



54310790



54314090



54312798



54324156



54333517



54312198



56121131



54314190



54338296



54324144



RE00803S



RE01917S



54306545

MWM D229 / TD229 4 CILINDROS 3.9 LITROS

84384146 KIT DE BORRACHA - ASPIRADO			
Nº ABR	DESCRIÇÃO	QTD	
50006241	VEDADOR 40,0X3,0 MM	2	
50005741	VEDADOR 20,0X4,0 MM	1	
50005941	VEDADOR 6,0X2,0 MM	1	
50010141	VEDADOR 20,0X2,0 MM	4	
50005541	VEDADOR 34,0X4,0 MM	1	
50004741	VEDADOR 44,0X3,0 MM	1	
50009941	VEDADOR 46,0X3,0 MM	1	

60014140 KIT DE ARRUELAS			
Nº ABR	DESCRIÇÃO	QTD	
50014130	ARRUELA AÇO 9,5 X 20,0 X 2,0MM	4	
50072428	ARRUELA ALUMÍNIO 22,2 X 27,0 X 1,0MM	2	
50012928	ARRUELA ALUMÍNIO 8,2 X 12,0 X 1,0MM	14	
50072928	ARRUELA ALUMÍNIO 10 X 16 X 1,0MM	4	
50012128	ARRUELA ALUMÍNIO 8 X 14 X 1,0MM	4	
50015728	ARRUELA ALUMÍNIO 10,2 X 14,0 X 1,0MM	1	
50021429	ARRUELA ALUMÍNIO 14 X 18 X 1,5MM	12	

84395246 KIT DE BORRACHA - TURBINADO			
Nº ABR	DESCRIÇÃO	QTD	
50026941	VEDADOR 75,0X3,0 MM	1	
50005741	VEDADOR 20,0X4,0 MM	1	
50005941	VEDADOR 6,0X2,0 MM	2	
50010141	VEDADOR 20,0X2,0 MM	4	
50005541	VEDADOR 34,0X4,0 MM	1	
50004741	VEDADOR 44,0X3,0 MM	1	
54384640	VEDADOR 42,0X3,0 MM	2	
54386740	VEDADOR 1 2,5X2,6 MM	1	
50037141	VEDADOR 14,0X3,0 MM	4	
54385640	VEDADOR 40,0X5,0 MM	2	
54387840	VEDADOR 25,0X4,0 MM	1	

MWM 4.10(X10/4CILINDROS) EURO2 4.3 LITROS 8VÁLVULAS ASPIRADO

MWM 6.10(X10/6CILINDROS) EURO2 6.45 LITROS 12VÁLVUAS ASPIRADO E TURBO

Nº JOGO		DESCRIÇÃO				
64315061	JOGO DE JUNTAS COMPLETO X10 4 CILINDROS SEM RETENTORES		1			
74315061	JOGO DE JUNTAS COMPLETO X10 4 CILINDROS COM RETENTORES		2			
64315071	JOGO DE JUNTAS COMPLETO X10 6 CILINDROS SEM RETENTORES		3			
74315071	JOGO DE JUNTAS COMPLETO X10 6 CILINDROS COM RETENTORES		4			
Nº ABR	Nº ORIGINAL	DESCRIÇÃO				
54364904	961008540144	JUNTA DO CABEÇOTE 4.10 / 6.10 Ø115MM	6	6	4	4
54353444	961008530014	JUNTA DA TAMPA DAS VÁLVULAS	6	6	4	4
54351417	961008530204	JUNTA DO COLETOR DE ESCAPAMENTO	6	6	4	4
54353216	941008530164	JUNTA DO COLETOR DE ADMISSÃO	6	6	4	4
54397167	961008530234	JUNTA DO CÂRTER 6 CILINDROS (SECCIONADA)	1	1		
54397267	941008530174	JUNTA DO CÂRTER 4 CILINDROS (SECCIONADA)			1	1
54352090	961008530234	JUNTA DO CÂRTER 6 CILINDROS				
54360990	941008530174	JUNTA DO CÂRTER 4 CILINDROS				
54350790	961008530324	JUNTA DA TAMPA DA DISTRIBUIÇÃO (INTERMEDIÁRIA) 6.10	1	1		
54369590	941008530234	JUNTA DA TAMPA DA DISTRIBUIÇÃO (INTERMEDIÁRIA)	1	1	1	1
54362590	941008530284	JUNTA DA TAMPA DA DISTRIBUIÇÃO (INTERMEDIÁRIA) 4.10			1	1
54349790	961088530374	JUNTA DA TAMPA DA DISTRIBUIÇÃO (FRONTAL) 6.10	1	1		
54362690	941008530194	JUNTA DA TAMPA DA DISTRIBUIÇÃO (FRONTAL)	1	1	1	1
RE02872F		RETENTOR TRASEIRO DO VIRABREQUIM 130X160X12MM	1		1	
RE02871F		RETENTOR DIANTEIRO DO VIRABREQUIM 78X100X13MM	1		1	
RE02927F		RETENTOR DA HASTE DAS VÁLVULAS 8,7X13,45X11MM	12		8	
54308395	961008528014	JUNTA DO TUBO DE LUBRIFICAÇÃO DO TURBO ALIMENTADOR	1	1		
54308490	961008528024	JUNTA PARA RETORNO DO ÓLEO	1	1		
54325016	961008530284	JUNTA DA CURVA DE ESCAPE	1	1		
54325117	922908530754	JUNTA DA TURBINA 6 FUROS (MAIOR)	1	1		
54349490	941008530104	JUNTA DA CARÇAÇA PARA RESPIRO	1	1	1	1
54349890	941008530114	JUNTA DO RADIADOR DO ÓLEO	2	2	2	2
54350590	961008530174	JUNTA DO BOCAL DE ENTRADA DE ÁGUA	1	1	1	1
54350690	961008530314	JUNTA PARA ALTERNADOR	1	1		
54350990	941008530204	JUNTA DO CABEÇOTE DO INTERCAMBIADOR	1	1	1	1
54351090	961008530094	JUNTA DO TERMOSTATO	1	1	1	1
54353108	961008530194	JUNTA DA CURVA DO COLETOR DE ESCAPAMENTO	1	1		
54353816	961008530164	JUNTA DA CURVA DO COLETOR DE ADMISSÃO	1	1		
54355432	961008530214	JUNTA DA BASE DA TURBINA	1	1		
54355544	961008530124	JUNTA DA TAMPA DE INSPEÇÃO	4	4	3	3
54355990	941008530084	JUNTA DA BOMBA ALIMENTADORA	1	1	1	1
54360216	941088530414	JUNTA DO COLETOR DE ADMISSÃO			1	1
54360395	941008530094	JUNTA PARA BOMBA INJETORA	1	1	1	1
54360516	941008530034	JUNTA DO ESCAPAMENTO			1	1
54367716	961088530384	JUNTA DO COLETOR DE ADMISSÃO	1	1		
54376845	904931361131	ANEL DE CAMISA 113,5 X 4,0 MM	12	12	8	8
84384826		KIT DE ARRUELAS - 6.10	1	1		
84384926		KIT DE ARRUELAS - 4.10			1	1
84385046		KIT DE BORRACHAS - 6.10	1	1		
84385146		KIT DE BORRACHAS - 4.10			1	1

● VENDE-SE AVULSO

MWM 4.10(X10/4CILINDROS) EURO2 4.3 LITROS 8VÁLVULAS ASPIRADO

MWM 6.10(X10/6CILINDROS) EURO2 6.45 LITROS 12VÁLVUAS ASPIRADO E TURBO

APLICAÇÃO

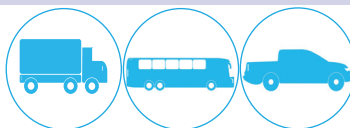

MWM 4.10(X10/4 CIL) VW CAMINHÃO 7100/8140 1994/00 ; 8100 1997/00 ; 8120 2000/12 ; 8150 2000/05 ; 12140T 1997/00 ; 7110 2002/05 ;
MWM 4.10(X10/4 CIL) AGRALE CAMINHÃO 7000 DX 1996/02 ; 7500 TDX 1996/04 ; 6000 D 2003/05 ; 6000 D E-MEC 2005/12 ; 8500 E-TRONIC 2005/12 8500 E-MEC 2005/09 ; 9200 2003/05 ; 9200 E-MEC 2009/12 ; 8500 1997/05
MWM 6.10(X10/6 CIL) VW CAMINHÃO 14150 1991/99 ; 14200 1991/94 ; 13180/15180 2000/05 ; 14180 1999/00 ; 23210/17210/15210 2002/06 ; 12180 1999/01 ; VW ÔNIBUS 16180 CO 1991/97 ; 16210 CO 1997/...17240 OT 2001/04
MWM 6.10(X10/6 CIL) FORD CAMINHÃO F14000HD 1992/98 ; C-1618 1992/99 ; FORD ÔNIBUS B-1618/B-1621 1992/99 B-12000 1996/99
MWM 6.10(X10/6 CIL) AGRALE CAMINHÃO 13000 2007/12 ; VOLVO CAMINHÃO VM17-210/VM17-240/VM23-210/VM23-240 2003/05
MWM 4.10(X10/4 CIL) VW ÔNIBUS 8140 CO/CE 1994/01 ; 13150 2000/06 ; 8150 OD/9150 OD 2001/...8120 OD 2003/...
MWM 4.10(X10/4 CIL) AGRALE ÔNIBUS FURGOVAN 8000 2004/11 ; MA 7.9 2004/12 ; MA 7.0 1996/06 ; MA 8.5 1997/05 ; MA 7.5T 1996/05
MWM 4.10(X10/4 CIL) VOLARE ÔNIBUS A8 2000/10 ; V8 2000/12 ; W8 2000/04
MWM 4.10(X10/4 CIL) FORD PICK-UP F1000 1996/98 ; F4000 1993/98

MWM 4.10(X10/4CILINDROS) EURO2 4.3 LITROS 8VÁLVULAS ASPIRADO
MWM 6.10(X10/6CILINDROS) EURO2 6.45 LITROS 12VÁLVULAS ASPIRADO E TURBO

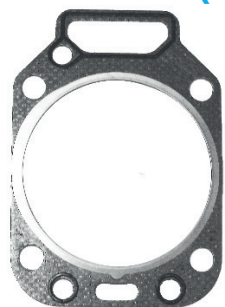

54364904



54360990



54325090

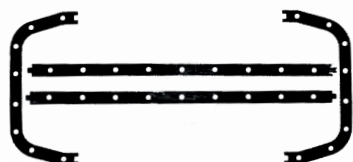

54397167

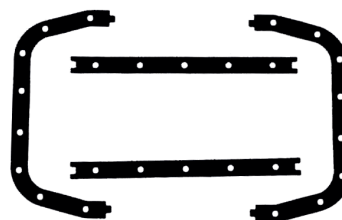

54397267



54369590

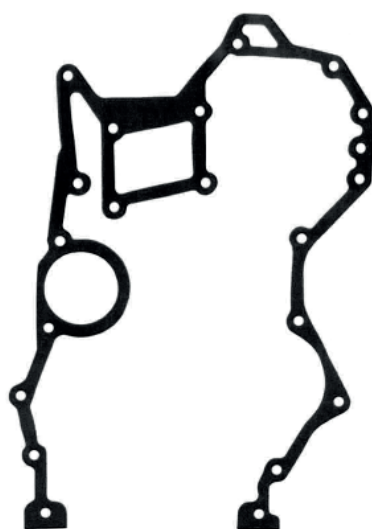

54362590

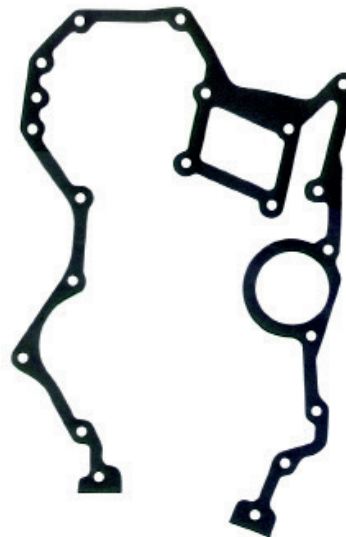

54350790

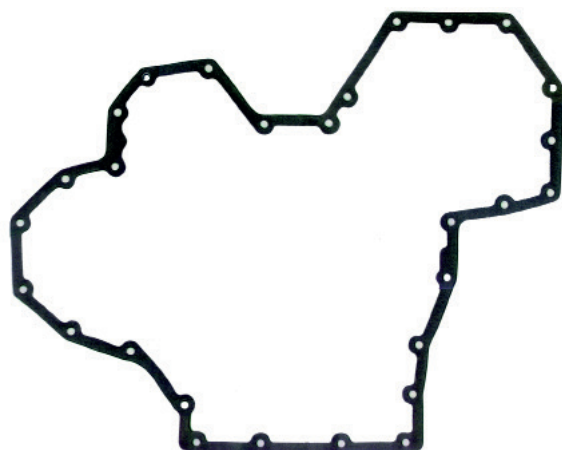

54362690

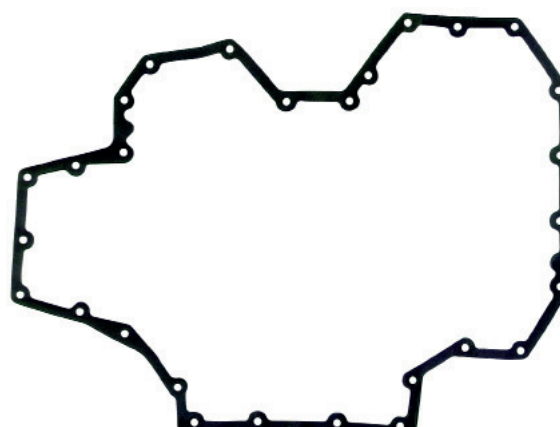

54349790



RE02872F



RE02871F



54355544



54353444

MWM 4.10(X10/4CILINDROS) EURO2 4.3 LITROS 8VÁLVULAS ASPIRADO

MWM 6.10(X10/6CILINDROS) EURO2 6.45 LITROS 12VÁLVULAS ASPIRADO E TURBO



54325117

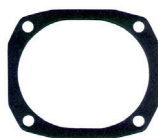

54350690



54355432



5432016



54360516



54351090



54367716



54353816



54353108



54349490



54350990



54353216



54351417



54308490



54308395



54360216



54350590



54349890



54355990



54376845



54360395



RE02927F

84384826		KIT DE ARRUELAS 6.10	
Nº ABR	DESCRIÇÃO	QTD	
50082724	ARRUELA COBRE 14,5 X 17,8 X 1,50 MM	3	
50015428	ARRUELA ALUMÍNIO 10,0 X 14,0 X 1,0 MM	1	
50013028	ARRUELA ALUMÍNIO 8,5X13,8X1,0 MM	4	
50015528	ARRUELA ALUMÍNIO 10,0 X 16,0 X 1,0 MM	4	
50021429	ARRUELA ALUMÍNIO 14,2X18,0X1,50 MM	15	
	ARRUELA COBRE 22,5 X 27,0 X 1,50 MM	1	
54356330	ARRUELA AÇO 7,3x15x2,00 MM	6	

84384926		KIT DE ARRUELAS 4.10	
Nº ABR	DESCRIÇÃO	QTD	
	ARRUELA COBRE 22,5 X 27,1 X 1,5MM	1	
	ARRUELA ALUMÍNIO 8,1X13,8X1,0MM	6	
50015528	ARRUELA ALUMÍNIO 10,0 X 16,0 X 1,0MM	2	
50021429	ARRUELA ALUMÍNIO 14,2X18,0X1,50MM	10	
	ARRUELA ALUMÍNIO 12,2 X 17,8 X 1,5MM	4	
	ARRUELA ALUMÍNIO 18,3X24,0X1,5MM	2	
	ARRUELA ALUMÍNIO 22,0X29,4X2,0MM	1	
54356330	ARRUELA AÇO 7,3X15X2,00MM	4	

84385046		KIT DE BORRACHAS 6.10	
Nº ABR	DESCRIÇÃO	QTD	
50026941	VEDADOR 75,0X3,0 MM	2	
50010641	VEDADOR 24,0X4,0 MM	6	
50028941	VEDADOR 125,8X3,0 MM	1	
54388440	VEDADOR 50,52X1,78 MM	2	
50011241	VEDADOR 34,0X3,0 MM	1	
54306241	VEDADOR 40,0X3,0 MM	2	
50005141	VEDADOR 7,65X1,78 MM	6	
50037141	VEDADOR 14,0X3,0 MM	6	
54386440	VEDADOR 28,0X5,0 MM	2	
50010841	VEDADOR 25,5X2,8 MM	1	
54387440	VEDADOR 86,5X5,3 MM	1	
50005741	VEDADOR 20,0X4,0 MM	1	
54388040	VEDADOR 78,0X2,0 MM	1	
50034341	VEDADOR 11,0X3,4 MM	1	

84385146		KIT DE BORRACHAS 4.10	
Nº ABR	DESCRIÇÃO	QTD	
50026941	VEDADOR 75,0X3,0 MM	1	
50010641	VEDADOR 24,0X4,0 MM	4	
50028941	VEDADOR 125,8X3,0 MM	1	
54388440	VEDADOR 50,52X1,78 MM	2	
50011241	VEDADOR 34,0X3,0 MM	1	
54306241	VEDADOR 40,0X3,0 MM	2	
54387440	VEDADOR 86,5X5,3 MM	1	
50005141	VEDADOR 7,65X1,78 MM	4	
50037141	VEDADOR 14,0X3,0 MM	4	
54386440	VEDADOR 28,0X5,0 MM	2	
50002741	VEDADOR 43,0X50,5X6,5 MM	1	

MWM 4.12(X12/4CILINDROS) TURBO 4.8 LITROS 8 VÁLVULAS(EURO3)
MWM 6.12(X12/6CILINDROS) TURBO 7.2 LITROS 12 VÁLVULAS(EURO3)

Nº JOGO		DESCRIÇÃO				
64315032	JOGO DE JUNTAS COMPLETO 4.12TCE X12 4 CILINDROS COM ANÉIS DE CAMISA SEM RETENTORES		1			
74315032	JOGO DE JUNTAS COMPLETO 4.12TCE X12 4 CILINDROS COM ANÉIS DE CAMISA COM RETENTORES		2			
64315042	JOGO DE JUNTAS COMPLETO 6.12TCE X12 6 CILINDROS COM ANÉIS DE CAMISA SEM RETENTORES		3			
74315042	JOGO DE JUNTAS COMPLETO 6.12TCE X12 6 CILINDROS COM ANÉIS DE CAMISA COM RETENTORES		4			
Nº ABR	Nº ORIGINAL	DESCRIÇÃO				
543119202	961208540034	JUNTA DO CABEÇOTE (COM VEDADORES) Ø115MM	3	3	2	2
54353444	961008530034	JUNTA DA TAMPA DE VÁLVULAS	6	6	4	4
54351417	961008530204	JUNTA DO COLETOR DE ESCAPAMENTO	6	6	4	4
54353216	961008530144	JUNTA DO COLETOR DE ADMISSÃO	6	6	4	4
54397167	961008530234	JUNTA DO CÂRTER 6 CILINDROS (SECCIONADA)	1	1		
54397267	941008530174	JUNTA DO CÂRTER 4 CILINDROS (SECCIONADA)			1	1
54352090	961088530354	JUNTA DO CÂRTER 6 CILINDROS				
54360990	941088530374	JUNTA DO CÂRTER 4 CILINDROS				
54391477	961208530014	JUNTA DA TAMPA DE DISTRIBUIÇÃO	1	1	1	1
54396377	961208530024	JUNTA DA TAMPA DE DISTRIBUIÇÃO (INTERMEDIÁRIA)	1	1	1	1
RE02872F		RETENTOR TRASEIRO DO VIRABREQUIM 130X160X12MM	1		1	
RE02871F		RETENTOR DIANTEIRO DO VIRABREQUIM 78X100X13MM	1		1	
RE02927F		RETENTOR DA HASTE DAS VÁLVULAS 8,7X13,45X11MM	12		8	
54308395	961008528014	JUNTA DO TUBO DE LUBRIFICAÇÃO DO TURBO ALIMENTADOR	1	1		
54308490	961008528024	JUNTA DO RETORNO DO ÓLEO	1	1		
54325117	922908530754	JUNTA DA TURBINA 6 FUROS (MAIOR)	1	1		
54340367	922908531054	JUNTA DA TAMPA/COLETOR DE ADMISSÃO			1	1
54347319	961283400024	JUNTA DO CALÇO DE CAMISA	6	6	4	4
54349490	941088530324	JUNTA DA CARÇAÇA DO RESPIRO	1	1	1	1
54349890	941088530334	JUNTA DO RADIADOR DO ÓLEO	2	1	2	1
54350590	941088530354	JUNTA DO BOCAL DA ENTRADA DE ÁGUA	1	1	1	1
54350990	941088530394	JUNTA DO INTERCAMBIADOR	1	1	1	1
54351090	961008530094	JUNTA DO TERMOSTATO	1	1	1	1
54355432	961008530214	JUNTA DA BASE DA TURBINA	1	1	1	1
54355544	961008530124	ANEL VEDAÇÃO DA TAMPA DE INSPEÇÃO	2	2	2	2
54370667	960788530074	JUNTA DO RETORNO DE ÓLEO			1	1
54376845	904931361131	JUNTA DA VEDAÇÃO DA CAMISA	12	12	8	8
54393647	941208530014	JUNTA DA CURVA DE ADMISSÃO	2	1	1	1
54395967	941208530034	JUNTA DO RETORNO DO ÓLEO			1	1
84395826		KIT DE ARRUELAS 4.12			1	1
84395926		KIT DE ARRUELAS 6.12	1	1		
84396046		KIT DE BORRACHAS 4.12			1	1
84396146		KIT DE BORRACHAS 6.12	1	1		
543107630	961288530014	VEDADOR DA JUNTA DE CABEÇOTE	6	6	4	4

● VENDE-SE AVULSO

MWM 4.12(X12/4CILINDROS) TURBO 4.8 LITROS 8 VÁLVULAS(EURO3)
MWM 6.12(X12/6CILINDROS) TURBO 7.2 LITROS 12 VÁLVULAS(EURO3)

APLICAÇÃO

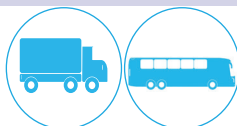

4.12 (X12 4 CIL) VW CAMINHÃO 13180/15180/17180 2006/12 ; VW ÔNIBUS 15180 EOD 2004/...15190 EOD 2007/..

4.12 (X12 4 CIL) AGRALE CAMINHÃO 9200 E-Tronic 2005/12 ; MARRUÁ AM41 2013/...

4.12 (X12 4 CIL) VOLVO CAMINHÃO VM17-210/VM23-210 2005/11

6.12(X12/6 CIL) VW CAMINHÃO 31260 2005/...

4.12 (X12 4 CIL) AGRALE ÔNIBUS MA 9.2 2004/12 ; MA 7.9 2004/12 ; MA 10.0/MA 15.0 2007/12 ; MA 8.5 2006/12

4.12 (X12 4 CIL) VOLARE ÔNIBUS W8 2005/12 ; W9 2006/12 ; D9W 2011/12

6.12(X12/6 CIL) VW ÔNIBUS 17260 EOD 2004/12 ; 17260 EOT 2007/12 ; 17260 OD 2012/...17230/18230 EOD 2007/...17210 EOD 2006/11

6.12(X12/6 CIL) VOLVO CAMINHÃO VM260/VM310 2006/12

MWM 4.12(X12/4CILINDROS) TURBO 4.8 LITROS 8 VÁLVULAS(EURO3)

MWM 6.12(X12/6CILINDROS) TURBO 7.2 LITROS 12 VÁLVULAS(EURO3)



543119202



54360990



54352090

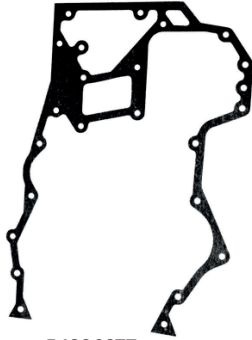

54396377

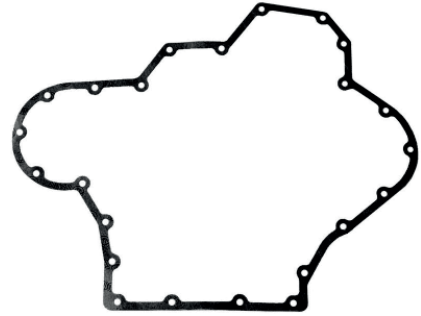

54391477

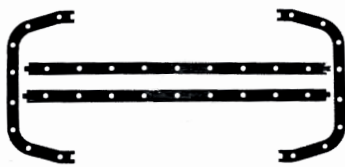

54397167

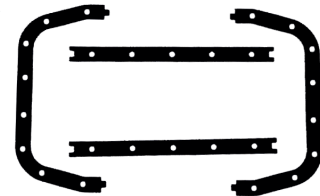

54397267



543107630



54349490



54308490



54308395



54370667



54395967



54349890



54350590



54351090



54393647



54340367



54351417



54353216



54355432



54325117

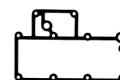

54350990



54376845



54353444



54347319



RE02872F



RE02871F



54355544



RE02927F

MWM 4.12(X12/4CILINDROS) TURBO 4.8 LITROS 8 VÁLVULAS(EURO3)
MWM 6.12(X12/6CILINDROS) TURBO 7.2 LITROS 12 VÁLVULAS(EURO3)

84396046 KIT DE BORRACHA 4.12		
Nº ABR	DESCRIÇÃO	QTD
50010641	VEDADOR 24,0 X 3,80MM	4
50005141	VEDADOR 7,65X1,78MM	4
50026941	VEDADOR 75,0 X 3,0MM	1
54387440	VEDADOR 86,5X5,3MM	1
54388040	VEDADOR 78,0X2,0MM	1
54387640	VEDADOR 50,0X3,55MM	1
54387040	VEDADOR 58,0X2,6MM	1
54385540	VEDADOR 35,0X3,0MM	1
50005541	VEDADOR 34,0X4,0MM	1
	VEDADOR 8,2X2,40MM	1
	VEDADOR 17,2X1,80MM	8
	VEDADOR 91,6X3,00MM	1
	VEDADOR 212,6X3,40MM	1

84395826 KIT DE ARRUELAS 4.12		
Nº ABR	DESCRIÇÃO	QTD
	ARRUELA COBRE 22,5 X 27,0 X 1,50MM	2
50013028	ARRUELA ALUMÍNIO 8,5 X 13,8 X 1,0MM	8
50021429	ARRUELA ALUMÍNIO 14,2 X 18,0 X 1,50MM	17
	ARRUELA ALUMÍNIO 22,0 X 29,4 X 2,0MM	1
50011024	ARRUELA COBRE 7,3 X 15,0 X 2,0MM	4
50029725	ARRUELA ALUMÍNIO 24,5 X 28,8 X 2,0MM	1
50027329	ARRUELA ALUMÍNIO 20,5 X 25,9 X 1,50MM	1
50023329	ARRUELA ALUMÍNIO 16,2 X 22,0 X 1,5MM	2
54356330	ARRUELA COBRE CU 8,3 X 12,0 X 1,0MM	8

84396146 KIT DE BORRACHAS 6.12		
Nº ABR	DESCRIÇÃO	QTD
50005741	VEDADOR 20,0 X 4,00MM	1
50005141	VEDADOR 7,65X1,78MM	6
54385540	VEDADOR 35,0X3,0MM	1
54385440	VEDADOR 24,0X3,5MM	6
54387440	VEDADOR 86,5X5,3MM	1
54387640	VEDADOR 50,0X3,55MM	1
54387040	VEDADOR 58,0X2,6MM	2
54387240	VEDADOR 78,0X3,0MM	1
	VEDADOR 8,2X2,40MM	1
	VEDADOR 17,2X1,80MM	8
	VEDADOR 91,6X3,00MM	1
	VEDADOR 212,6X3,4MM	1

84395926 KIT DE ARRUELAS 6.12		
Nº ABR	DESCRIÇÃO	QTD
50072429	ARRUELA ALUMÍNIO 22,5 X 26,7 X 1,50MM	2
	ARRUELA ALUMÍNIO 8,2 X 13,8 X 1,0MM	8
50021429	ARRUELA ALUMÍNIO 14,2 X 18,0 X 1,50MM	18
	ARRUELA ALUMÍNIO 22,0 X 29,4 X 2,0MM	1
50011024	ARRUELA COBRE 7,3 X 15,0 X 2,0MM	6
50029725	ARRUELA ALUMÍNIO 24,5 X 28,8 X 2,0MM	1
50027329	ARRUELA ALUMÍNIO 20,5 X 25,9 X 1,50MM	1
50023729	ARRUELA ALUMÍNIO 16,3 X 21,6 X 1,5MM	2
	ARRUELA COBRE 8,3 X 12,0 X 1,0MM	12
	ARRUELA ALUMÍNIO 12,2 X 18,0 X 1,50MM	2
50019224	ARRUELA COBRE 12,3 X 18,0 X 1,50MM	2
50069229	ARRUELA ALUMÍNIO 18,2 X 21,9 X 1,50MM	1

MWM SPRINT 4.07 TCA 4 CILINDROS 2.8 LITROS

MWM SPRINT 4.07 TCE 2.8 LITROS/4.08 TCE ELETRÔNICO 4 CILINDROS 3.0 LITROS(EURO3)

Nº JOGO		DESCRIÇÃO							
64315083	JOGO DE JUNTAS COMPLETO MWM SPRINT 4.07 TCA SEM RETENTORES						1		
74315083	JOGO DE JUNTAS COMPLETO MWM SPRINT 4.07 TCA COM RETENTORES						2		
74385081	JOGO DE JUNTAS SUPERIOR SPRINT 4.07 TCA COM RETENTORES						3		
64315103	JOGO DE JUNTAS COMPLETO MWM SPRINT 4.07 TCE/4.08 TCE ELETRÔNICO SEM RETENTORES						4		
74315103	JOGO DE JUNTAS COMPLETO MWM SPRINT 4.07 TCE/4.08 TCE ELETRÔNICO COM RETENTORES						5		
74335103	JOGO DE JUNTAS SUPERIOR SPRINT 4.07 TCE/4.08 TCE ELETRÔNICO COM RETENTORES						6		
Nº ABR	Nº ORIGINAL	DESCRIÇÃO							
54395700	940708540074	JUNTA DO CABEÇOTE Ø96MM – FIBRA					1 1 1		
54395702		JUNTA DO CABEÇOTE Ø96MM – METÁLICA		1	1	1			
54393744	940708530034	JUNTA DA TAMPA DE VÁLVULAS		1	1	1	1	1	1
54370967	960708530084	JUNTA DO COLETOR DE ESCAPAMENTO		4	4	4	4	4	4
54369643	940708530084	JUNTA DO COLETOR DE ADMISSÃO 4.07 TCA					1 1 1		
54378167	940708530164	JUNTA DO COLETOR DE ADMISSÃO 4.07 TCE/4.08 TCE ELETRÔNICO		1	1	1			
54360767	940708530014	JUNTA DO CÂRTER					1 1 1		
54367473	940708530124	JUNTA DA TAMPA DE DISTRIBUIÇÃO					1 1 1		
RE02629F	904960640910	RETENTOR TRASEIRO DO VIRABREQUIM 91X111X10MM					1 1 1		
RE05055F	904960640643	RETENTOR DIANTEIRO DO VIRABREQUIM 64X80X9MM					1 1 1		
RE09228F	904960640069	RETENTOR DA HASTE DE VÁLVULA 7X10,5X9,2MM		12	12		12	12	
54360395	941008530094	JUNTA DA BOMBA INJETORA					1 1 1		
54368147	940708530054	JUNTA DA CURVA DE ADMISSÃO					1 1 1		
54370667	960788530074	JUNTA DO TUBO DO RETORNO DO ÓLEO		1	1	1			
54370867	940788530094	JUNTA DO RESFRIADOR DE ÓLEO					1 1 1		
54371247	940708530134	JUNTA DO RESFRIADOR DE ÓLEO					1 1 1		
54382167	940708530174	JUNTA DA BOMBA INJETORA					1 1 1		
54383267	940788530184	JUNTA DA BOMBA DE ÓLEO		1	1		1 1 1		
54391067	940708530224	JUNTA DO RESFRIADOR DE ÓLEO					1 1 1		
54396267	940808530014	JUNTA DO FILTRO DO RESFRIADOR ÓLEO					1 1 1		
543101267	940808530034	JUNTA DO FILTRO DO RESFRIADOR ÓLEO					1 1 1		
84385726		KIT DE ARRUELAS 4.07 TCA					1 1 1		
84385940		KIT DE BORRACHAS 4.07 TCA					1 1 1		
84396846		KIT DE BORRACHAS 4.07 TCE/4.08 TCE ELETRÔNICO		1	1	1			
84397026		KIT DE ARRUELAS 4.07 TCE/4.08 TCE ELETRÔNICO		1	1	1			

• VENDE-SE AVULSO

MWM SPRINT 4.07 TCA 4 CILINDROS 2.8 LITROS

MWM SPRINT 4.07 TCE 2.8 LITROS/4.08 TCE ELETRÔNICO 4 CILINDROS 3.0 LITROS(EURO3)

APLICAÇÃO

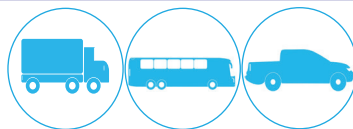

SPRINT 4.07 TCA AGRALE CAMINHÃO 6000 2003/05,AGRALE ÔNIBUS FURGOVAN 6000 1997/05

SPRINT 4.07 TCA NISSAN PICK-UP FRONTIER TD/X-TERRA TD 2002/05,VOLARE ÔNIBUS A5 2002/05,A6 1998/05

SPRINT 4.07 TCE ELETRÔNICO VOLKSWAGEN CAMINHÃO DELIVERY 5140/8150/9150 2005/12,VOLKSWAGEN ÔNIBUS 5140 EOD/8150 EOD 2005/..

SPRINT 4.07 TCE ELETRÔNICO AGRALE CAMINHÃO 6000 E-TRONIC 2005/12,8500 2010/12,MARRUÁ 2006/12,AGRALE ÔNIBUS FURGOVAN 6000 2005/11

SPRINT 4.07 TCE ELETRÔNICO NISSAN PICK-UP FRONTIER TD 2005/08(BRASIL),VOLARE ÔNIBUS V5/V6 2005/12

MWM SPRINT 4.07 TCA 4CILINDROS 2.8LITROS

MWM SPRINT 4.07 TCE 2.8 LITROS/4.08 TCE ELETRÔNICO 4 CILINDROS 3.0 LITROS(EURO3)



54395702



54395700



54393744

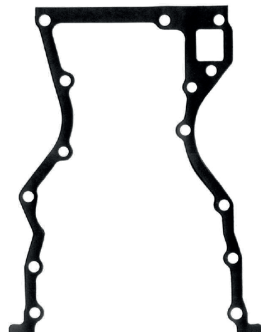

54367473



5436077



54383267



54378167



54369643



543101267



54370667



54396267



54391067



54370967



54368147



54360395



54382167

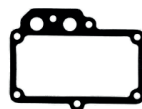

54370867



54371247



RE02629F



54355544



RE05055F



RE09228F

MWM SPRINT 4.07 TCA 4 CILINDROS 2.8 LITROS

MWM SPRINT 4.07 TCE 2.8 LITROS/4.08 TCE ELETRÔNICO 4 CILINDROS 3.0 LITROS(EURO3)

84385940 KIT DE BORRACHAS 4,07 TCA		
Nº ABR	DESCRIÇÃO	QTD
04384540	VEDADOR 27,0x3,55MM	1
04384840	VEDADOR 32,50x2,90MM	1
04385140	VEDADOR 40,0x3,50MM	1
04315340	VEDADOR 45,0x3,0MM	1
04315540	VEDADOR 67,0x3,53MM	1
04385840	VEDADOR 80,0x2,43MM	1
04385540	VEDADOR 82,0x3,40MM	1
04385640	VEDADOR 106,20x3,55MM	1
04369040	ELEMENTO DE VEDAÇÃO ESPAÇADOR	5
043103440	ELEMENTO DE VEDAÇÃO	4

84396846 KIT DE BORRACHAS 4.07 TCE/4.08 TCE ELETRÔNICO		
Nº ABR	DESCRIÇÃO	QTD
543101740	VEDADOR 32,50X2,65MM	1
543101840	VEDADOR 43,70X2,65MM	2
543102040	VEDADOR 85,00X3,55MM	1
543102140	VEDADOR 87,50X3,55MM	1
543102240	VEDADOR 28,00X3,55MM	2
543102340	VEDADOR 60,00X3,55MM	1
543103040	VEDADOR 106,00X3,55MM	1
543103240	VEDADOR 41,20X3,55MM	1
543103840	VEDADOR 37,70X60,00X2,7MM	1
54385840	VEDADOR 92,5X3,55MM	1
54390340	VEDADOR 67,00X3,55MM	1
54390640	VEDADOR 44,80X2,80MM	1
50037141	VEDADOR 14,0 X 3,0MM	4
54387640	VEDADOR 50,0X3,55MM	1
54369041	ELEMENTO DE VEDAÇÃO ESPAÇADOR	5
543110340	VEDADOR 53,00X3,55MM	1
543110440	VEDADOR 58,00X3,55MM	1
543110540	VEDADOR 77,50X3,55MM	1
543110640	VEDADOR 63,09X3,53MM	1
543110740	VEDADOR 85,32X3,53MM	1
54370741	VEDADOR 42,5 x 49,0 x 5,8 MM	2

84397026 KIT DE ARRUELAS 4,07 TCA		
Nº ABR	DESCRIÇÃO	QTD
50011223	ARRUELA COBRE 8,0 X 12,0 X 1,0MM	5
50011428	ARRUELA ALUMÍNIO 8,1 X 13,8 X 1,0MM	2
50015528	ARRUELA ALUMÍNIO 10,0 X 16,0 X 1,0MM	2
50022029	ARRUELA ALUMÍNIO 14,5 X 17,8 X 1,5MM	6
50023624	ARRUELA COBRE 16,3 X 19,8 X 1,50MM	3
50023629	ARRUELA ALUMÍNIO 16,3 X 19,8 X 1,5MM	4
50023729	ARRUELA ALUMÍNIO 16,3 X 21,6 X 1,5MM	2
50026724	ARRUELA COBRE 20,0 X 26,0 X 1,50MM	3
50026729	ARRUELA ALUMÍNIO 20,0 X 26,0 X 1,50MM	3
50028225	ARRUELA ALUMÍNIO 21,4X29,4X2,0MM	3
50070329	ARRUELA ALUMÍNIO 18,5 X 21,7 X 1,5MM	2
50072429	ARRUELA ALUMÍNIO 22,5 X 26,7 X 1,5MM	2
50951720	ARRUELA COBRE 7,3x15,3x1,98/2,08MM	4

84385726 KIT DE ARRUELAS 4,07 TCA		
Nº ABR	DESCRIÇÃO	QTD
50011223	ARRUELA COBRE 8,0 X 12,0 X 1,0MM	16
50026724	ARRUELA COBRE 20,0 X 26,0 X 1,50MM	1
50011228	ARRUELA ALUMÍNIO 8,0 X 12,0 X 1,0MM	4
50015728	ARRUELA ALUMÍNIO 10,2 X 13,9 X 1,0MM	1
	ARRUELA ALUMÍNIO 12,2 X 18,0 X 1,5MM	2
	ARRUELA ALUMÍNIO 14,5 X 18,0 X 1,5MM	1
50023629	ARRUELA ALUMÍNIO 16,3 X 19,8 X 1,5MM	1
	ARRUELA ALUMÍNIO 18,5 X 22,0 X 1,5MM	2
50027129	ARRUELA ALUMÍNIO 20,3 X 23,8 X 1,5MM	1
	ARRUELA ALUMÍNIO 21,9X29,4X2,0MM	1
50072429	ARRUELA ALUMÍNIO 22,5 X 26,7 X 1,5MM	1
50011428	ARRUELA ALUMÍNIO 8,1 X 13,8 X 1,0MM	1
50012938	ARRUELA AÇO 8,3 X 11,4 X 1,0MM	4

MWM SPRINT 6.07 TCA 6CILINDROS 4.2LITROS

Nº JOGO		DESCRIÇÃO		
64315093		JOGO DE JUNTAS COMPLETO MWM SPRINT 6.07 TCA SEM RETENTORES		1
74315093		JOGO DE JUNTAS COMPLETO MWM SPRINT 6.07 TCA COM RETENTORES		2
Nº ABR	Nº ORIGINAL	DESCRIÇÃO		
54395800	960708548164	JUNTA DO CABEÇOTE Ø96MM		1 1
54393840	960708530014	JUNTA DA TAMPA DAS VÁLVULAS		1 1
54370967	960708530084	JUNTA DO COLETOR DE ESCAPAMENTO		6 6
54369750	960708530064	JUNTA DO COLETOR DE ADMISSÃO		1 1
54376990	960708530094	JUNTA DO CARTER		1 1
54367473	940708530124	JUNTA DA TAMPA DE DISTRIBUIÇÃO		1 1
RE02629F	904960640910	RETENTOR TRASEIRO DO VIRABREQUIM 91X111X10MM		1
RE05055F	904960640643	RETENTOR DIANTEIRO DO VIRABREQUIM 64X80X9MM		1
RE09228F	904960640069	RETENTOR DA HASTE DE VÁLVULA 7X10,5X9,2MM		18
54360395	941008530094	JUNTA DA BOMBA INJETORA		1 1
54370447	960788530054	JUNTA DO DUTO DO COLETOR DE ADMISSÃO		1 1
54370667	960788530074	JUNTA DO TUBO DO RETENTOR DE ÓLEO		1 1
54370867	940708530094	JUNTA DO RESFRIADOR DE ÓLEO		1 1
54371247	940708530134	JUNTA DO RESFRIADOR DE ÓLEO		1 1
54382167	940708530174	JUNTA DA BOMBA INJETORA		1 1
54383267	940788530184	JUNTA DA BOMBA DE ÓLEO		1 1
84385826		KIT DE ARRUELAS		1 1
84386040		KIT DE BORRACHAS		1 1

• VENDE-SE AVULSO

MWM SPRINT 6.07 TCA 6CILINDROS 4.2LITROS

APLICAÇÃO



FORD TRUCK F250 1999/2006

CHEVROLET TRUCK GMC3500 HD/GMC6150 1997/02

WMW SPRINT 6.07 6CILINDROS 4.2LITROS



54395800

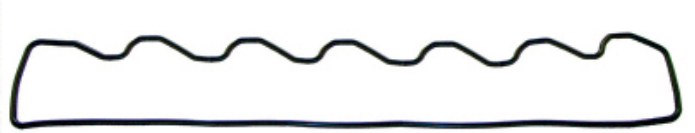

54393840



54376990



54369750

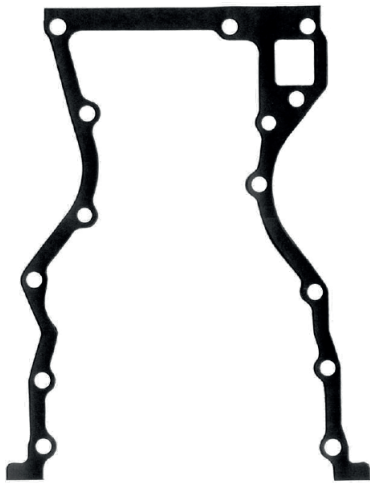

54367473



54383267

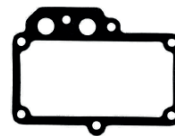

54370867

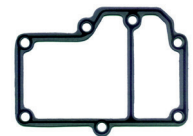

54371247



RE02629F



RE05055F

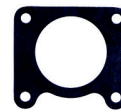

54370447



54360395



54382167



54370967



54370667



RE09228F

WMW SPRINT 6.07 6CILINDROS 4.2LITROS

84386040 KIT DE BORRACHA SPRINT 6.07		
Nº ABR	DESCRIÇÃO	QTD
5.4385640	VEDADOR 40,0 X 5,0 MM	2
543102440	VEDADOR 13,2 X 1,8 MM	2
543102540	VEDADOR 22,5 X 2,65 MM	1
543102640	VEDADOR 28,2 X 3,55 MM	1
543102740	VEDADOR 31,5 X 2,65 MM	1
543103240	VEDADOR 41,2 X 3,55 MM	1
54390340	VEDADOR 67,0 X 3,55 MM	1
543102840	VEDADOR 82,5 X 3,55 MM	1
543102940	VEDADOR 103,0 X 3,55 MM	1
543103040	VEDADOR 106,2 X 3,55 MM	1
543103140	VEDADOR 80,2 X 2,5 MM	1
54390640	VEDADOR 44,8 X 2,8 MM	1
543103340	VEDADOR 33,0 X 3,0 MM	1
543102240	VEDADOR 28,0 X 3,55 MM	2
543102340	VEDADOR 60,0 X 3,55 MM	1
543110340	VEDADOR 53,0 X 3,55 MM	1
543110440	VEDADOR 58,0 X 3,55 MM	1
543110540	VEDADOR 77,5 X 3,55 MM	1
543110740	VEDADOR 85,32 X 3,53 MM	1
54385840	VEDADOR 92,5 X 3,55 MM	1
54387640	VEDADOR 50,0 X 3,55 MM	1
54370740	VEDADOR 42,5 X 49,0 X 5,8 MM	1
54369041	ELEMENTO DE VEDAÇÃO ESPAÇADOR	7

84385826 KIT DE ARRUELAS SPRINT 6.07		
Nº ABR	DESCRIÇÃO	QTD
50009923	ARRUELA COBRE 6,0 X 10,0 X 1,0MM	1
50011223	ARRUELA COBRE 8,0 X 12,0 X 1,0MM	24
50011228	ARRUELA ALUMÍNIO 8,0 X 12,0 X 1,0MM	4
50015728	ARRUELA ALUMÍNIO 10,2 X 13,9 X 1,0MM	1
	ARRUELA ALUMÍNIO 12,2 X 18,0 X 1,5MM	2
	ARRUELA ALUMÍNIO 18,5 X 22,0 X 1,5MM	2
50027129	ARRUELA ALUMÍNIO 20,3 X 23,8 X 1,5MM	1
	ARRUELA ALUMÍNIO 22,0X29,4X2,0MM	1
50011428	ARRUELA ALUMÍNIO 8,1 X 13,8 X 1,0MM	1
50012938	ARRUELA AÇO 8,3 X 11,4 X 1,0MM	18

MWM MAXXFORCE 4CILINDROS TURBO 4.8LITROS 16VÁLVULAS(EURO 5)

MWM MAXXFORCE 6CILINDROS TURBO 7.2LITROS 24VÁLVULAS(EURO 5)

Nº JOGO		DESCRIÇÃO							
64315145	JOGO DE JUNTAS COMPLETO MAXXFORCE 4 CILINDROS EURO V SEM RETENTORES							1	
74315145	JOGO DE JUNTAS COMPLETO MAXXFORCE 4 CILINDROS EURO V COM RETENTORES							2	
74335145	JOGO DE JUNTAS SUPERIOR MAXXFORCE 4 CILINDROS EURO V COM RETENTORES							3	
64315165	JOGO DE JUNTAS COMPLETO MAXXFORCE 6 CILINDROS EURO V SEM RETENTORES							4	
74315165	JOGO DE JUNTAS COMPLETO MAXXFORCE 6 CILINDROS EURO V COM RETENTORES							5	
74335165	JOGO DE JUNTAS SUPERIOR MAXXFORCE 6 CILINDROS EURO V COM RETENTORES							6	
84335165	JOGO DE JUNTAS MONOCILÍNDRICO MWM MAXXFORCE EURO V SEM RETENTORES							7	
Nº ABR	Nº ORIGINAL	DESCRIÇÃO							
543122705	7002797C1	JUNTA DO CABEÇOTE Ø106mm	1	6	6	6	4	4	4
543106540	961208530104	JUNTA DA TAMPA DE VÁLVULAS	1	6	6	6	4	4	4
543101569	961208530144	JUNTA DO COLETOR DE ESCAPAMENTO	1	6	6	6	4	4	4
543101447	961208530134	JUNTA DO COLETOR DE ADMISSÃO	2	12	12	12	8	8	8
54360977	941088530374	JUNTA DO CÂRTER 4 CIL							1
543105867	7004252C1	JUNTA DO CÂRTER 6 CIL			1	1			
543106830	7002390C1	JUNTA DA TAMPA FRONTAL			1	1		1	1
RE02872F		RETENTOR TRASEIRO DO VIRABREQUIM 130X160X12MM			1			1	
RE09105T		RETENTOR DIANTEIRO DO VIRABREQUIM 76X95X13MM			1			1	
RE09109F		RETENTOR DA HASTE DE VÁLVULAS 6X14X15,50MM		24	24		16	16	
50011024		ARRUELA COBRE 7,3X15,0X2,0 M	1						
54366577	941088530454	JUNTA DO TUBO DO RETORNO DE OLEO	1	1	1	1	1	1	1
54367077	941088530444	JUNTA DA ENTRADA DE ÓLEO	1	1	1	1	1	1	1
84397626		KIT DE ARRUELAS DO JOGO INFERIOR			1	1		1	1
84397726		KIT DE ARRUELAS DO JOGO SUPERIOR	1	1	1	1	1	1	1
84397846		KIT DE BORRACHAS DO JOGO INFERIOR			1	1		1	1
84397946		KIT DE BORRACHAS DO JOGO SUPERIOR	1	1	1	1	1	1	1
543111130	7002858C1	JUNTA DO RESFRIADOR DE ÓLEO			1	1		1	1
543112204	7000201C1	JUNTA DA CURVA DE ADMISSÃO	1	1	1	1	1	1	1
543122847	9612085300114	JUNTA DO RESFRIADOR DE ÓLEO			1	1		1	1
543122947	9612085300124	JUNTA DO RESFRIADOR DE ÓLEO			1	1		1	1
543200032	7002389C2	JUNTA DO TURBOALIMENTADOR	1	1	1	1	1	1	1

• VENDE-SE AVULSO

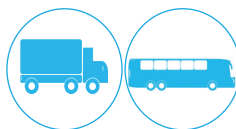
MWM MAXXFORCE 4CILINDROS TURBO 4.8LITROS 16VÁLVULAS(EURO 5)**MWM MAXXFORCE 6CILINDROS TURBO 7.2LITROS 24VÁLVULAS(EURO 5)****APLICAÇÃO**

MAXXFORCE 4 CILINDROS AGRAL TRUCK 10000 2013/...10000 LX/14000 LX 2016/17

MAXXFORCE 4 CILINDROS AGRAL BUS MA 9.2/MA 10.0/MA 12.0/MA 15.0 2013/...

MAXXFORCE 4 CILINDROS VOLARE BUS W9 FLY/DW9 FLY/W8 FLY 2012/14 ; WL FLY 2013/14 ; W9/DW9/W8/WL 2014/...

MAXXFORCE 6 CILINDROS AGRAL BUS MA 17.0 2013/...

MAXXFORCE 6 CILINDROS VOLVO TRUCK VM220/270/330 2012/...

MWM MAXXFORCE 4CILINDROS TURBO 4.8LITROS 16VÁLVULAS(EURO 5)

MWM MAXXFORCE 6CILINDROS TURBO 7.2LITROS 24VÁLVULAS(EURO 5)



543122705

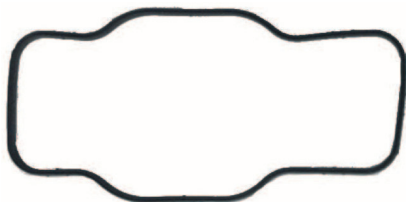

543106540

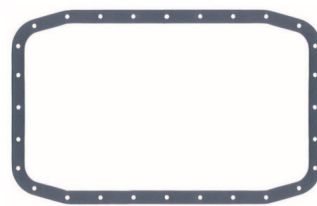

54360977



543106830



543105867

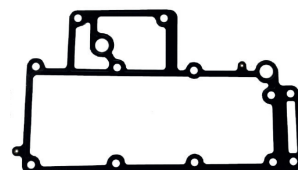

543111130



543122847



543122947



54367077



54366577



543101569



543112204



543101447



543200032



RE02872F



RE09105T



RE09109F



50011024

MWM MAXXFORCE 4CILINDROS TURBO 4.8LITROS 16VÁLVULAS(EURO 5)
MWM MAXXFORCE 6CILINDROS TURBO 7.2LITROS 24VÁLVULAS(EURO 5)

84397626 KIT DE ARRUELAS DO JOGO INFERIOR		
Nº ABR	DESCRIÇÃO	QTD
	ARRUELA ALUMÍNIO 14,2 X 17,8 X 1,5MM	6
	ARRUELA ALUMÍNIO 8,3 X 13,8 X 1,0MM	4
	ARRUELA COBRE 14,2 X 17,8 X 1,5MM	2
	ARRUELA ALUMÍNIO 12,2 X 17,8 X 1,5MM	1

84397726 KIT DE ARRUELAS DO JOGO SUPERIOR		
Nº ABR	DESCRIÇÃO	QTD
	ARRUELA ALUMÍNIO 21,5 X 29,8 X 2,0MM	1
	ARRUELA COBRE 14,0 X 18,0 X 1,5MM	4
	ARRUELA ALUMÍNIO 12,2 X 17,8 X 1,5MM	2
	ARRUELA COBRE 12,2 X 17,8 X 1,5MM	2
	ARRUELA COBRE 7,3 X 15,0 X 2,0MM	6
	ARRUELA ALUMÍNIO 10,1 X 15,8 X 1,0MM	14
	ARRUELA ALUMÍNIO 8,3 X 13,8 X 1,1MM	6

84397846 KIT DE BORRACHAS DO JOGO INFERIOR		
Nº ABR	DESCRIÇÃO	QTD
	VEDADOR 101,5 X 108,5 X 3,5MM	1
	VEDADOR 86,8 X 97,5 X 5,2MM	1
	VEDADOR 78,3 x 84,1 x 3,0mm	1
	VEDADOR 78,0 x 82,0 x 2,0mm	1
	VEDADOR 58,2 x 65,2 x 3,5mm	1
	VEDADOR 58,2 x 62,0 x 1,7mm	1
	VEDADOR 34,5 x 40,2 x 2,8mm	1
	VEDADOR 19,7 x 27,8 x 4,0mm	1
	VEDADOR 17 x 20,5 x 1,7mm	1
	VEDADOR 55,5 x 21,0 x 2,6 x 4,9mm	1

84397946 KIT DE BORRACHAS DO JOGO SUPERIOR		
Nº ABR	DESCRIÇÃO	QTD
	VEDADOR 60,0 X 67,0 X 3,5MM	2
	VEDADOR 23,5 X 31,5 X 3,1MM	6
	VEDADOR 20,0 x 26,3 x 2,9mm	6
	VEDADOR 17,0 x 20,5 x 1,7mm	12
	VEDADOR 4,0 x 7,0 x 1,5mm	12
	VEDADOR 5,8 x 9,6 x 1,8mm	12
	VEDADOR 6,0 x 10,0 x 2,0mm	12

 **MAXION PERKINS**

MAXION

Nº ABR	MOTOR	DESCRIÇÃO		PÁGINA
70910572	NGD 3.0	JOGO DE JUNTAS COMPLETO	COM RETENTORES	116
70930572	NGD 3.0	JOGO DE JUNTAS SUPERIOR	COM RETENTORES	116
60910359	3152	JOGO DE JUNTAS COMPLETO	SEM RETENTORES E COM INJEÇÃO INDIRETA	118
70910359	3152	JOGO DE JUNTAS COMPLETO	COM RETENTORES E COM INJEÇÃO INDIRETA	118
70930359	3152	JOGO DE JUNTAS COMPLETO	COM RETENTORES E COM INJEÇÃO INDIRETA	118
60910361	D3152	JOGO DE JUNTAS COMPLETO	SEM RETENTORES E COM INJEÇÃO INDIRETA	124
70910361	D3152	JOGO DE JUNTAS COMPLETO	COM RETENTORES E COM INJEÇÃO INDIRETA	124
60930361	D3152	JOGO DE JUNTAS COMPLETO	SEM RETENTORES E COM INJEÇÃO INDIRETA	118
70910831	4203	JOGO DE JUNTAS COMPLETO	SEM RETENTORES E COM INJEÇÃO INDIRETA	122
70932931	4203	JOGO DE JUNTAS COMPLETO	SEM RETENTORES E COM INJEÇÃO INDIRETA	128
60912931	4203	JOGO DE JUNTAS COMPLETO	SEM RETENTORES E COM INJEÇÃO INDIRETA	128
70912931	4203	JOGO DE JUNTAS COMPLETO	SEM RETENTORES E COM INJEÇÃO INDIRETA	122
60913001	4203	JOGO DE JUNTAS COMPLETO	SEM RETENTORES E COM INJEÇÃO INDIRETA	126
70913001	4203	JOGO DE JUNTAS COMPLETO	SEM RETENTORES E COM INJEÇÃO INDIRETA	132
70932791	4203	JOGO DE JUNTAS SUPERIOR	SEM RETENTORES E COM INJEÇÃO INDIRETA	126
60912981	D4236/4238	JOGO DE JUNTAS COMPLETO	SEM RETENTORES	130
70912981	D4236/4238	JOGO DE JUNTAS COMPLETO	COM RETENTORES	136
70913981	T4236	JOGO DE JUNTAS COMPLETO	COM RETENTORES	136
60913031	T4236	JOGO DE JUNTAS COMPLETO	SEM RETENTORES	130
60916151	D4236/4248	JOGO DE JUNTAS COMPLETO	SEM RETENTORES	134
70916151	D4236/4248	JOGO DE JUNTAS COMPLETO	COM RETENTORES	140
70916151	4236 / 4248	JOGO DE JUNTAS COMPLETO	COM RETENTORES	140
70933031	4236 / 4248	JOGO DE JUNTAS SUPERIOR	COM RETENTORES	134
70930051	4236 / 4248	JOGO DE JUNTAS COMPLETO	COM RETENTORES	138
60910151	Q20B/4236	JOGO DE JUNTAS COMPLETO	SEM RETENTORES	144
70910151	Q20B/4236	JOGO DE JUNTAS COMPLETO	COM RETENTORES	144
60930051	Q20B/D4236/4248	JOGO DE JUNTAS COMPLETO	SEM RETENTORES	138
70930051	Q20B/D4236/4248	JOGO DE JUNTAS COMPLETO	COM RETENTORES	142
60914763		JOGO DE JUNTAS COMPLETO	SEM RETENTORES	148
70914763		JOGO DE JUNTAS COMPLETO	COM RETENTORES	148
60934763		JOGO DE JUNTAS SUPERIOR	SEM RETENTORES	148
60914053		JOGO DE JUNTAS COMPLETO	SEM RETENTORES	148
70914053		JOGO DE JUNTAS COMPLETO	COM RETENTORES	142
60934053		JOGO DE JUNTAS SUPERIOR	SEM RETENTORES	146
60914753	P4000/94000T	JOGO DE JUNTAS COMPLETO	SEM RETENTORES	152
70914753	P4000/94000T	JOGO DE JUNTAS COMPLETO	COM RETENTORES	146
70934751	P4000/94000T	JOGO DE JUNTAS COMPLETO	COM RETENTORES E COM HASTE DE VÁLVULA	150
60914733	S4/S4T	JOGO DE JUNTAS COMPLETO	COM RETENTORES	156
70914733	S4/S4T	JOGO DE JUNTAS COMPLETO	COM RETENTORES	150
70934731	S4/S4T	JOGO DE JUNTAS SUPERIOR	COM RETENTORES E COM HASTE DE VÁLVULA	154
60914773	HS 2.5	JOGO DE JUNTAS COMPLETO	SEM RETENTORES	160
70914773	HS 2.5	JOGO DE JUNTAS COMPLETO	COM RETENTORES	160
60934773	HS 2.5	JOGO DE JUNTAS SUPERIOR	SEM RETENTORES	154
70934773	HS 2.5	JOGO DE JUNTAS SUPERIOR	COM RETENTORES E COM HASTE DE VÁLVULA	158
60914873	HS 2.8	JOGO DE JUNTAS COMPLETO	COM RETENTORES	164
70914873	HS 2.8	JOGO DE JUNTAS COMPLETO	COM RETENTORES	164
60934873	HS 2.8	JOGO DE JUNTAS SUPERIOR	COM RETENTORES	158
70934873	HS 2.8	JOGO DE JUNTAS SUPERIOR	COM RETENTORES	162
60913761	P6354.4	JOGO DE JUNTAS COMPLETO	COM RETENTORES	168
70913761	P6354.4	JOGO DE JUNTAS COMPLETO	COM RETENTORES	168
70933761	P6354.4	JOGO DE JUNTAS SUPERIOR	COM RETENTORES E COM HASTE DE VÁLVULA	162
60913763	P6354.4	JOGO DE JUNTAS COMPLETO	SEM RETENTORES	166
60913761	P6354.4	JOGO DE JUNTAS COMPLETO	SEM RETENTORES	172
70913761	P6354.4	JOGO DE JUNTAS COMPLETO	COM RETENTORES	172
70933761	P6354.4	JOGO DE JUNTAS COMPLETO	COM RETENTORES	166
60913763	P6354.4	JOGO DE JUNTAS SUPERIOR	SEM RETENTORES	170
60912881	P6357	JOGO DE JUNTAS COMPLETO	COM RETENTORES	176
70912881	P6357	JOGO DE JUNTAS COMPLETO	COM RETENTORES	170
70932881	P6357	JOGO DE JUNTAS SUPERIOR	COM RETENTORES	174
60913439	P6358	JOGO DE JUNTAS COMPLETO	SEM RETENTORES	174
70913439	P6358	JOGO DE JUNTAS COMPLETO	COM RETENTORES	174
70933431	P6358	JOGO DE JUNTAS SUPERIOR	COM RETENTORES	174

Nº JOGO		DESCRIÇÃO			
60910572		JOGO DE JUNTAS COMPLETO NGD 3.0L SEM RETENTORES	1		
70910572		JOGO DE JUNTAS COMPLETO NGD 3.0L COM RETENTORES	2		
70930572		JOGO DE JUNTAS SUPERIOR NGD 3.0L SEM RETENTORES	3		
Nº ABR	Nº ORIGINAL	DESCRIÇÃO			
50985302	70490185	JUNTA DO CABEÇOTE Ø98mm	1	1	1
50984740	70490701	JUNTA DA TAMPA DE VÁLVULAS	1	1	1
50981431	70490785	JUNTA DO COLETOR DE ESCAPAMENTO	4	4	4
50981531	3688C002	JUNTA DO COLETOR DE ADMISSÃO	4	4	4
50980967	70490705	JUNTA DA TAMPA DA DISTRIBUIÇÃO		1	1
RE05239F		RETENTOR TRASEIRO DO VIRABREQUIM		1	
RE09101S		RETENTOR DIANTEIRO DO VIRABREQUIM 60,7X79,4X9,5mm		1	
RE09102F		RETENTOR DA HASTE DE VÁLVULAS 5,2X11,7X20,0mm	16	16	
50951720		ARRUELA 7,3X5,3X2,00mm	4	4	4
50980440	70490709	JUNTA DO TUBO DE SUCÇÃO DE ÓLEO		1	1
50980540	70490708	JUNTA DA DISTRIBUIÇÃO		1	1
50980667	70490690	JUNTA DO RESFRIADOR DE ÓLEO		1	1
50981040	70490704	JUNTA DA BOMBA DE ÁGUA	1	1	1
50981867	70490692	JUNTA DA ALÇA DO LEVANTAMENTO DIANTEIRA		1	1
50984940	70590020	ANEL DA CAIXA DE DISTRIBUIÇÃO	1	1	1
50985740	70590021	ANEL DA TAMPA DE INSPEÇÃO	1	1	1
50987340	70490814	JUNTA DA BOMBA DE ALTA PRESSÃO		1	1
50992667		JUNTA DO TUBO DO RETENTOR DE ÓLEO		1	1
50992940	70490700	JUNTA ADAPTADOR INJETOR DA TAMPA DE VÁLVULAS	4	4	4
50997240	70490823	JUNTA DA CARÇA DA CAIXA DE DISTRIBUIÇÃO		1	1
50997840	70490824	JUNTA SUPERIOR DA CAIXA DE DISTRIBUIÇÃO		1	1
50977829		ARRUELA 24,5X30,0X2,00mm		1	1
809105740		KIT DE BORRACHAS		1	1

• VENDE-SE AVULSO

APLICAÇÃO



FORD RANGER 2005/12 ; TROLLER PANTANAL 2006/12

MAXION PERKINS INTERNACIONAL NGD 3.0 L 16 VÁLVULAS DIESEL (EURO 3)



50985302

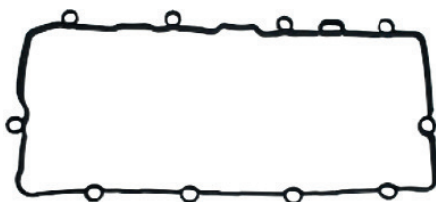

50984740

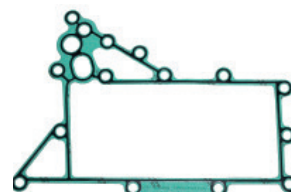

50980667



50980967



50981531



RE05239F



50992667



50981867



50981431



50980540

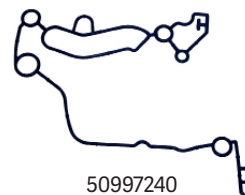

50997240

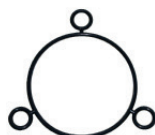

50987340



50992940



50981040



50984940



50997840



RE09101S



50985740



50980440



50977829



50951720



RE09102F

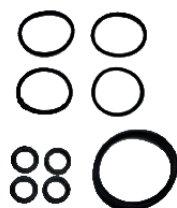

809105740

PERKINS P3152 INJEÇÃO INDIRETA 3 CILINDROS 2.4 LITROS
 PERKINS P3152 INJEÇÃO DIRETA 3 CILINDROS 2.4 LITROS

Nº JOGO		DESCRIÇÃO						
60910359	JOGO DE JUNTAS COMPLETO PERKINS 3152 INJEÇÃO INDIRETA SEM RETENTORES		1					
70910359	JOGO DE JUNTAS COMPLETO PERKINS 3152 INJEÇÃO INDIRETA COM RETENTORES		2					
70930359	JOGO DE JUNTAS SUPERIOR PERKINS 3152 INJEÇÃO INDIRETA SEM RETENTORES		3					
60910361	JOGO DE JUNTAS COMPLETO PERKINS D3152 INJEÇÃO DIRETA SEM RETENTORES		4					
70910361	JOGO DE JUNTAS COMPLETO PERKINS D3152 INJEÇÃO DIRETA COM RETENTORES		5					
60930361	JOGO DE JUNTAS SUPERIOR PERKINS D3152 INJEÇÃO DIRETA SEM RETENTORES		6					
Nº ABR	Nº ORIGINAL	DESCRIÇÃO						
50911509	70490822	JUNTA DO CABEÇOTE - INJEÇÃO INDIRETA Ø93MM				1	1	1
50971501	70490821	JUNTA DO CABEÇOTE - INJEÇÃO DIRETA Ø93MM	1	1	1			
50909550	490491	JUNTA DA TAMPA DE VÁLVULAS - INJEÇÃO INDIRETA				1	1	1
50953055	36811115	JUNTA DA TAMPA DE VÁLVULAS - INJEÇÃO DIRETA	1	1	1			
50909016	70490353	JUNTA DO COLETOR DE ESCAPAMENTO - INJEÇÃO INDIRETA				2	2	2
50949316	70490737	JUNTA DO COLETOR DE ESCAPAMENTO - INJEÇÃO DIRETA	2	2	2			
50911098	70490361	JUNTA DO COLETOR DE ADMISSÃO - INJEÇÃO INDIRETA				1	1	1
50949498	70490419	JUNTA DO COLETOR DE ADMISSÃO - INJEÇÃO DIRETA	1	1	1			
80919350		JOGO DE JUNTAS DO CARTER - INJEÇÃO INDIRETA						1
80966190		JOGO DE JUNTAS DO CARTER - INJEÇÃO DIRETA				1	1	
50912090	70490364	JUNTA DA TAMPA DE DISTRIBUIÇÃO				1	1	1
50912298	75490367	JUNTA DA TAMPA TRASEIRA DE DISTRIBUIÇÃO				1	1	1
RE01972S		RETENTOR TRASEIRO DO VIRABREQUIM 133,3X158,8X13,0MM				1		
RE00013S		RETENTOR DIANTEIRO DO VIRABREQUIM 57,8X76,2X12,7MM				1		1
50050567		GAXETA (CONJUNTO COM 2 PEÇAS)						1
50900898	70490348	JUNTA DA CONEXÃO DE VÁLVULA TERMOSTÁTICA	1	1	1	1	1	1
50906541	33817402	VEDADOR DA HASTE DAS VÁLVULAS - INJEÇÃO INDIRETA				6	6	6
50907190	490251	JUNTA DA PENEIRA DO CÁRTER						1
50909190	70490327	JUNTA DA CÂMARA DA VÁLVULA TERMOSTÁTICA	1	1	1	1	1	1
50909290	70490354	JUNTA DA CARÇAÇA DA BOMBA DE ÁGUA				1	1	1
50909390	70490355	JUNTA DA TAMPA TRASEIRA DO CABEÇOTE	1	1	1	1	1	1
50909490	70490356	JUNTA DA CONEXÃO DA ENTRADA DE ÁGUA				1	1	1
50910090	490685	JUNTA DO ACOPLAMENTO DA BOMBA INJETORA						1
50911298	70490357	JUNTA DO SUPORTE DO FILTRO DE ÓLEO				1	1	1
50912990	70490313	JUNTA COBERTA GIRABREQUIM						1
50913496	70490034	JUNTA DA TAMPA DA BOMBA HIDRÁULICA				1	1	1
50914198	70490381	JUNTA DO SUPORTE A BOMBA ALIMENTADORA						1
50914290	70490382	JUNTA DO ACIONADOR DI TACÔMETRO				1	1	1
50914396	70490343	JUNTA DA TAMPA DE INSPEÇÃO DA DISTRIBUIÇÃO	1	1	1			1
50916098	70490063	JUNTA DO ACOMPLAMENTO DA BOMBA INJETORA				1	1	
50923816	70490014	JUNTA DA SAÍDA DO ESCAPAMENTO	1	1	1	1	1	1
50926698	70490316	JUNTA DA BOMBA ALIMENTADORA				1	1	
50934616	70490373	JUNTA DA SAÍDA DE ESCAPAMENTO	1	1	1			
50949898	33826111	JUNTA DA TAMPA DO FILTRO DE ÓLEO				1	1	
50954898	70490321	JUNTA DA BOMBA DE ÁGUA	1	1	1			
80903226		KIT DE ARRUELAS - INJEÇÃO INDIRETA						1
80937623		KIT DE ARRUELAS - INJEÇÃO DIRETA	1	1	1			
80977940		KIT DE BORRACHAS	1	1	1			
RE00572S		RETENTOR TAQUÍMETRO						1

• VENDE-SE AVULSO

PERKINS P3152 INJEÇÃO INDIRETA 3 CILINDROS 2.4 LITROS
PERKINS P3152 INJEÇÃO DIRETA 3 CILINDROS 2.4 LITROS

APLICAÇÃO



P3152 INJEÇÃO INDIRETA – MASSEY FERGUSON TRACTOR MF 50X 1963/74 ; MF 55X 1974/...MF 235 1975/78 ; MF 250 1975/99 ; MF 350 1975/...

P3152 INJEÇÃO DIRETA – MASSEY FERGUSON TRACTOR MF 235 1980/98

PERKINS P3152 INJEÇÃO INDIRETA 3 CILINDROS 2.4 LITROS
PERKINS P3152 INJEÇÃO DIRETA 3 CILINDROS 2.4 LITROS

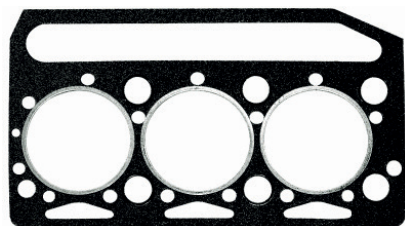

50911509

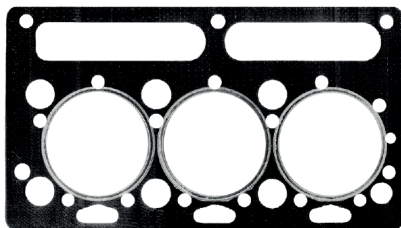

50971501

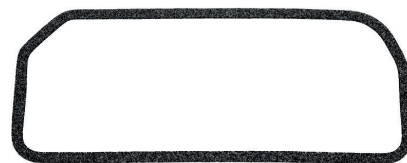

50909550

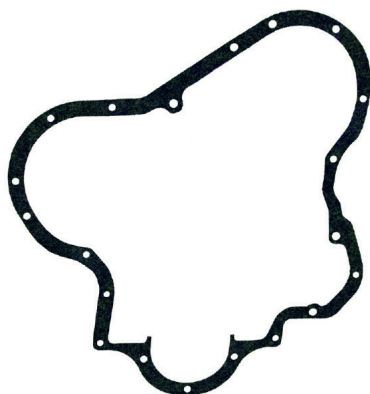

50912090

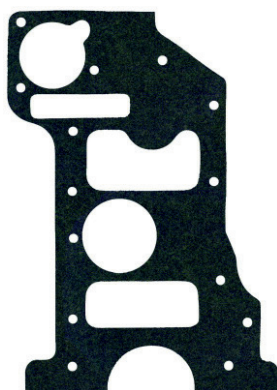

50912298

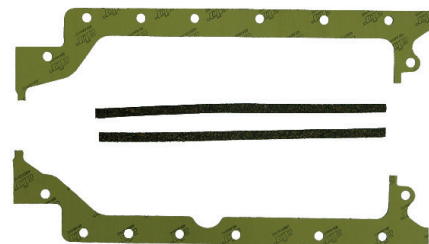

80966190



50953055



50949498

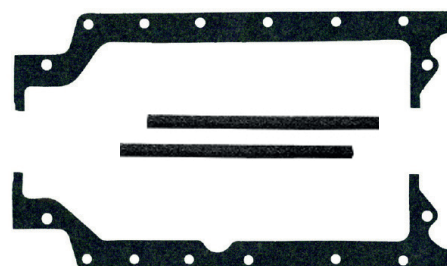

80919350

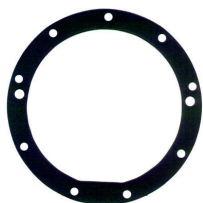

50949808

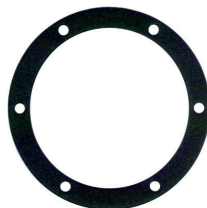

50907190



50909190

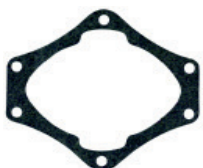

50912990

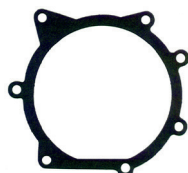

50954898



50914396



50909390



50911098

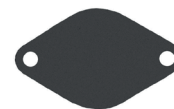

50913496

PERKINS P3152 INJEÇÃO INDIRETA 3 CILINDROS 2.4 LITROS
PERKINS P3152 INJEÇÃO DIRETA 3 CILINDROS 2.4 LITROS



50934616



50923816



50914290



50909290



50900898



50909016



50916098



50910090



50949316



50926698



50914198



50909490



50911298



RE01972S



RE00013S



RE00572S



50950548



50906541

80903226 KIT DE ARRUELAS - INJEÇÃO INDIRETA		
Nº ABR	DESCRIÇÃO	QTD
50022224	ARRUELA DE COBRE 14,0X20,8X1,5 MM	3
	ARRUELA DE COBRE 40,3X46,7X1,0 MM	3

80937623 KIT DE ARRUELAS - INJEÇÃO DIRETA		
Nº ABR	DESCRIÇÃO	QTD
50937620	ARRUELA DE COBRE 10X19,2X2,0 MM	3

80977940 KIT DE BORRACHA		
Nº ABR	DESCRIÇÃO	QTD
00972641	BASTÃO DA TAMPA DO INTERIOR AO BLOCO	2
50962240	VEDADOR DO BICO INJETOR	4
50963941	VEDADOR 6,0X10,5X6,0MM	1
	VEDADOR 47X2,6MM	1

PERKINS P4203 INJEÇÃO INDIRETA 4 CILINDROS 3.3 LITROS

Nº JOGO		DESCRIÇÃO			
60912931	JOGO DE JUNTAS COMPLETO 4203 INJEÇÃO INDIRETA SEM RETENTORES		1		
70912931	JOGO DE JUNTAS COMPLETO 4203 INJEÇÃO INDIRETA COM RETENTORES		2		
70932931	JOGO DE JUNTAS SUPERIOR 4203 INJEÇÃO INDIRETA SEM RETENTORES		3		
Nº ABR	Nº ORIGINAL	DESCRIÇÃO			
50911601	70490411	JUNTA DO CABEÇOTE - INJEÇÃO INDIRETA Ø93MM	1	1	1
50910450	490704	JUNTA DA TAMPA DE VÁLVULAS	1	1	1
50907016	70490818	JUNTA DO COLETOR DE ESCAPAMENTO	2	2	2
50906990	490042	JUNTA DO COLETOR DE ADMISSÃO	1	1	1
80924694	70990328	KIT DE JUNTAS DO CÂRTER	1	1	
50915290	70490031	JUNTA DA TAMPA DA DISTRIBUIÇÃO	1	1	
50923990	70490324	JUNTA DA TAMPA TRASEIRA DA DISTRIBUIÇÃO	1	1	
50050567	70730023	GAXETA (CONJUNTO COM 2 PEÇAS)	1	1	
RE00013N		RETENTOR DIANTEIRO DO VIRABREQUIM 57,8X76,2X12,7MM	1		
RE00572N		RETENTOR DO TAQUÍMETRO 22,3X34,95X6,4MM	1		
50010341		VEDADOR 23,3X3,50MM	1	1	
50906541	33817402	VEDADOR DA HASTE DAS VÁLVULAS - INJEÇÃO INDIRETA	8	8	8
50909390	70490355	JUNTA DA TAMPA TRASEIRA DO CABEÇOTE	1	1	1
50910198	490692	JUNTA DA CONEXÃO DA ENTRADA DE ÁGUA	1	1	
50910250	70490401	JUNTA DA TAMPA DO COMANDO	1	1	
50910390	70490359	JUNTA DA CONEXÃO DA SAÍDA DE ÁGUA	1	1	1
50910590	490706	JUNTA DO SUPORTE DA BOMBA INJETORA	1	1	
50910698	490707	JUNTA DA CONEXÃO SUPERIOR DA SAÍDA DE ÁGUA	1	1	1
50910798	70490360	JUNTA DA CONEXÃO DO DESVIO DE ÁGUA	1	1	1
50911298	70490357	JUNTA DO SUPORTE DO FILTRO DE ÓLEO	2	2	
50913098	36817141	JUNTA DA COBERTA DO VIRABREQUIM	1	1	
50913550	36846114	JUNTA DA TAMPA DE INSPEÇÃO (TRASEIRA)	1	1	1
50913850	36851107	JUNTA DA TAMPA DE INSPEÇÃO (DIANTEIRA)	1	1	1
50914198	70490381	JUNTA DO SUPORTE DA BOMBA ALIMENTADORA 0,80MM	1	1	
50914396	36862512	JUNTA DA TAMPA DE INSPEÇÃO DA DISTRIBUIÇÃO	1	1	
50914490	36865108	JUNTA DA TAMPA DO MANCAL	1	1	
50914698	70490342	JUNTA DA CARÇAÇA DA BOMBA INJETORA	1	1	
50916098	70490063	JUNTA DO ACOPLAMENTO DA BOMBA INJETORA	1	1	
50923816	70490014	JUNTA DO TUBO DE SAÍDA DO ESCAPAMENTO	1	1	1
50933811	80490032	JUNTA DO TUBO DE SAÍDA DO ESCAPAMENTO	1	1	1
50966140	2415745	ANEL CARÇAÇA DO RETENTOR	1	1	
80903426		KIT DE ARRUELAS	1	1	1

• VENDE-SE AVULSO

PERKINS P4203 INJEÇÃO INDIRETA 4 CILIDROS 3.3 LITROS

APLICAÇÃO



MASSEY FREGUSON TRACTOR MF 65 1965/82, CBT TRACTOR 1000 1975/...CASE TRACTOR 580E 1972/85

PERKINS P4203 INJEÇÃO INDIRETA 4 CILIDROS 3.3 LITROS

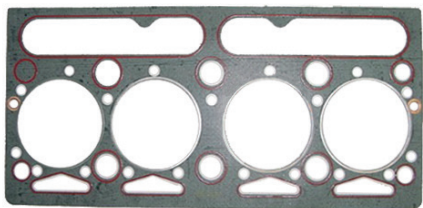

50911601



50910450



50906990

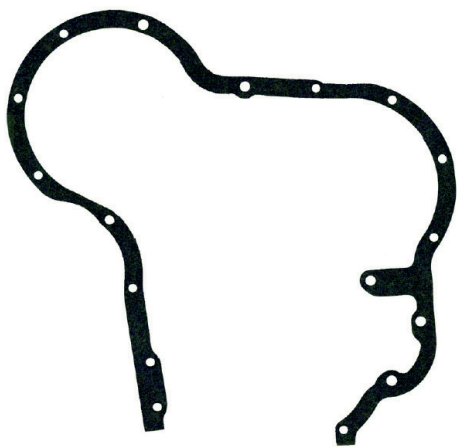

50915290



50913650

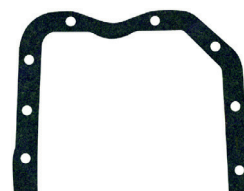

50914490

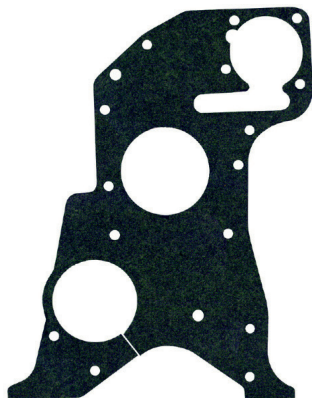

50923990

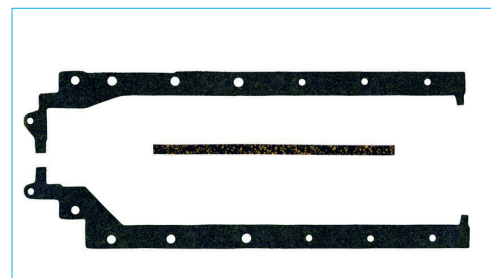

80924694

PERKINS P4203 INJEÇÃO INDIRETA 4 CILINDROS 3.3 LITROS



80903426		KIT DE BORRACHA	
Nº ABR	DESCRIÇÃO	QTD	
50022224	ARRUELA DE COBRE 14,0X20,8X1,5 MM	4	
	ARRUELA DE COBRE 40,3X46,8X1,0 MM	4	

PERKINS 4203 INJEÇÃO DIRETA 4 CILINDROS 3.3LITROS

Nº JOGO		DESCRIÇÃO				
60913001	JOGO DE JUNTAS COMPLETO P4203 INJEÇÃO DIRETA SEM RETENTORES			1		
70913001	JOGO DE JUNTAS COMPLETO P4203 INJEÇÃO DIRETA COM RETENTORES			2		
70932791	JOGO DE JUNTAS SUPERIOR P4203 INJEÇÃO DIRETA SEM RETENTORES			3		
Nº ABR	Nº ORIGINAL	DESCRIÇÃO				
50911701	70490742	JUNTA DO CABEÇOTE INJEÇÃO DIRETA Ø93MM		1	1	1
50900450	490704	JUNTA DA TAMPA DAS VÁLVULAS		1	1	1
50900316	70490344	JUNTA DO COLETOR DE ESCAPAMENTO		2	2	2
50914798	70490388	JUNTA DO COLETOR DE ADMISSÃO		1	1	1
80924694	70990328	KIT DE JUNTAS DO CÂRTER		1 1		
50915290	70490391	JUNTA DA TAMPA DA DISTRIBUIÇÃO		1 1		
50923990	70490324	JUNTA DA TAMPA TRASEIRA DA DISTRIBUIÇÃO		1 1		
50050567	70730023	GAXETA (CONJUNTO COM 2 PEÇAS)		1 1		
RE00013N		RETENTOR DIANTEIRO DO VIRABREQUIM 57,8X76,2X12,7MM		1		
RE00572N		RETENTOR DO TAQUÍMETRO 22,3X34,95X6,4MM		1		
50010341		VEDADOR 23,3 X 3,50MM		1 1		
50909390	70490355	JUNTA DA TAMPA TRASEIRA DO CABEÇOTE		1	1	1
50910198	490692	JUNTA DA CONEXÃO DA ENTRADA DE ÁGUA		1 1		
50910250	70490401	JUNTA DA TAMPA DO COMANDO		1 1		
50910390	70490359	JUNTA DA CONEXÃO DA SAÍDA DE ÁGUA		1	1	1
50910590	490706	JUNTA DO SUPORTE DA BOMBA INJETORA		1 1		
50910698	490707	JUNTA DA CONEXÃO SUPERIOR DA SAÍDA DE ÁGUA		1	1	1
50910798	70490360	JUNTA DA CONEXÃO DO DESVIO DE ÁGUA		1	1	1
50911298	70490357	JUNTA DO SUPORTE DO FILTRO DE ÓLEO		2 2		
50913098	36817141	JUNTA DA COBERTA DO VIRABREQUIM		1 1		
50914198	70490381	JUNTA DO SUPORTE DA BOMBA ALIMENTADORA 0,80MM		1 1		
50914396	36862512	JUNTA DA TAMPA DE INSPEÇÃO DA DISTRIBUIÇÃO		1 1		
50914490	36865108	JUNTA DA TAMPA DO MANCAL		1 1		
50914698	70490342	JUNTA DA CARÇA DA BOMBA D'ÁGUA		1 1		
50916098	70490063	JUNTA DO ACOPLAMENTO DA BOMBA INJETORA		1 1		
50923816	70490014	JUNTA DO TUBO DE SAÍDA DO ESCAPAMENTO		1	1	1
50933811	80490032	JUNTA DO TUBO DE SAÍDA DO ESCAPAMENTO		1	1	1
50966140	2415745	ANEL CARÇA DO RETENTOR		1 1		
80014124		KIT DE ARRUELAS		1	1	1

• VENDE-SE AVULSO

PERKINS 4203 INJEÇÃO DIRETA 4 CILINDROS 3.3LITROS

APLICAÇÃO



MASSEY FERGUSON TRACTOR MF 265 1976/83 ; MF 65X 1972/80

PERKINS 4203 INJEÇÃO DIRETA 4 CILINDROS 3.3LITROS

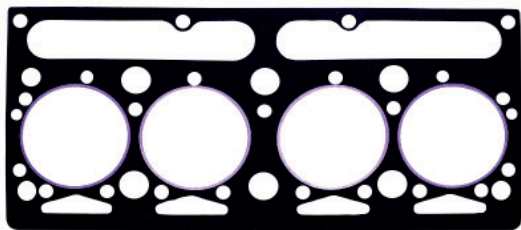

50911701

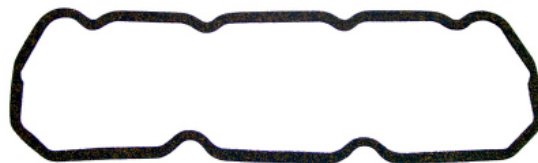

50900450

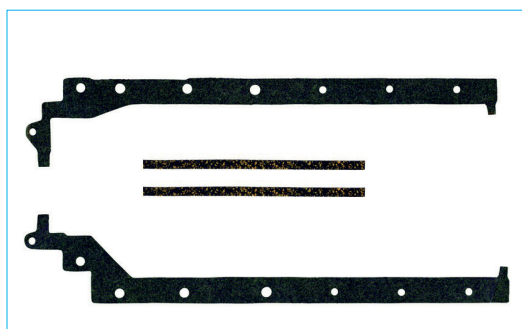

80924694



50914798

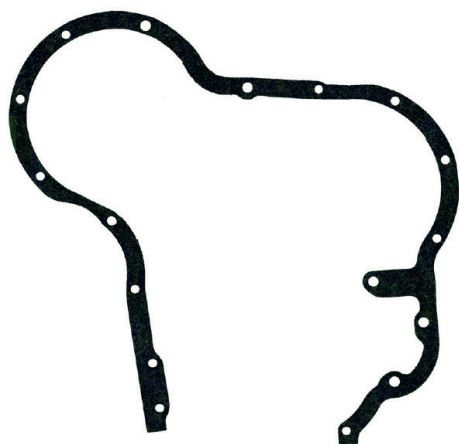

50915290

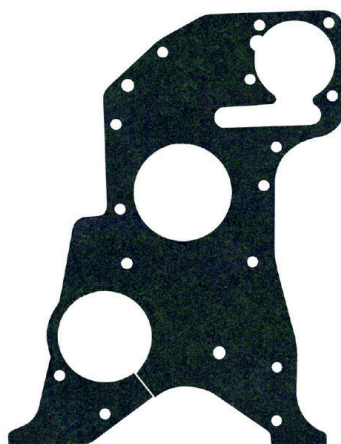

50923990

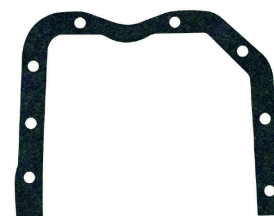

50914490

PERKINS 4203 INJEÇÃO DIRETA 4 CILINDROS 3.3LITROS



50933816



50910698



50900316



50910198



50914198



50911298



50923816



50910590



50916098



50910250

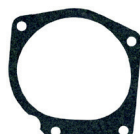

50914698



50910798

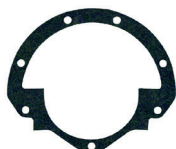

50913098



50914396



50966140



50909390



50909398



50910390



RE00572S



RE00013S



50950567

80014124 KIT DE ARRUELAS		
Nº ABR	DESCRIÇÃO	QTD
50014120	ARRUELA DE COBRE 9,5X20,0X2,00 MM	4

PERKINS P4236/P4248 4 CILINDROS 4.1 LITROS
 PERKINS P4236 4 CILINDROS 3.9 LITROS TURBO

Nº JOGO	DESCRIÇÃO
60912981	JOGO DE JUNTAS COMPLETO P4236/4248 4.1L SEM RETENTORES
70912981	JOGO DE JUNTAS COMPLETO P4236/4248 4.1L COM RETENTORES
60913031	JOGO DE JUNTAS COMPLETO P4236 3.9L TURBO SEM RETENTORES
70913031	JOGO DE JUNTAS COMPLETO P4236 3.9L TURBO COM RETENTORES

Nº ABR	Nº ORIGINAL	DESCRIÇÃO	1	2	3	4
50965504	70490304	JUNTA DO CABEÇOTE Ø 105MM	1	1	1	1
50918655	70490266	JUNTA DA TAMPA DAS VÁLVULAS	1	1	1	1
50926016	36862134	JUNTA DO COLETOR DE ESCAPAMENTO			2	2
50951630	36.88C.007	JUNTA DO COLETOR DE ESCAPAMENTO	2	2		
50917996	36866462	JUNTA DO COLETOR DE ADMISSÃO (TRASEIRA)	1	1	1	1
50925890	36862131	JUNTA DO COLETOR DE ADMISSÃO (DIANTEIRA)	1	1	1	1
50925990	36862133	JUNTA DO COLETOR DE ADMISSÃO (CENTRAL)	1	1	1	1
50944430	36.88C.003	JUNTA DO COLETOR DE ADMISSÃO (DIANTEIRA)	1	1		
50944630	36.88C.002	JUNTA DO COLETOR DE ADMISSÃO (CENTRAL)	1	1		
50944730	36.88C.001	JUNTA DO COLETOR DE ADMISSÃO (TRASEIRA)	1	1		
50925390	36815721	JUNTA DO CÂRTER (4236 / 4248 AGRÍCOLA)	1	1	1	1
50924890	70490311	JUNTA DA TAMPA DA DISTRIBUIÇÃO	1	1	1	1
RE01050S		RETENTOR DIANTEIRO DO VIRABREQUIM 60,4X79,35X9,3MM	1	1		
RE01972S		RETENTOR TRASEIRO DO VIRABREQUIM 133,3X158,8X13MM	1	1		
RE02590F		RETENTOR DA HASTE DAS VÁLVULAS 9,5X14,3X12,3MM	8		8	
50014120		ARRUELA DO BICO INJETOR 9,5 X 20,0 X 2,0 MM	4	4	4	4
50911498	70490402	JUNTA DA TAMPA DE INSPEÇÃO DA DISTRIBUIÇÃO	1	1	1	1
50913298	70490377	JUNTA DA CONEXÃO DE ÁGUA	1	1	1	1
50916098	70490063	JUNTA DO ACOPLAMENTO DA BOMBA INJETORA	1	1	1	1
50918398	70490379	JUNTA DA TAMPA TRASEIRA DO CABEÇOTE	1	1	1	1
50918798	70490368	JUNTA TRASEIRA DA DISTRIBUIÇÃO	1	1	1	1
50920898	36866722	JUNTA DA BOMBA DE ÓLEO				1 1
50923498	70490385	JUNTA DA CAIXA AO ADAPTADOR	1	1	1	1
50924412	70490414	JUNTA DO TUBO DE SAÍDA DO ESCAPAMENTO	1	1	1	1
50925590	36817136	JUNTA DA CARÇAÇA AO BLOCO				1 1
50925698	70490378	JUNTA DO ACIONAMENTO DO TAQUÍMETRO	1	1	1	1
50925790	70490408	JUNTA DO TERMOSTATO DO CABEÇOTE	1	1	1	1
50926198	70490380	JUNTA DA CONEXÃO DE ÁGUA	1	1	1	1
50926298	70490320	JUNTA DO BOCAL DE ABASTECIMENTO	1	1	1	1
50926498	70490383	JUNTA DO FILTRO DE ÓLEO	1	1	1	1
50926598	70490383	JUNTA DO CORPO DA BOMBA D'ÁGUA	1	1	1	1
50926698	70490316	JUNTA DA BOMBA ALIMENTADORA	1	1	1	1
50930198	0490734	JUNTA DO TERMOSTATO	1	1	1	1
50931757	36825107	JUNTA DA INSPEÇÃO DO TAQUÍMETRO				1 1
50931998	70490412	JUNTA DA BOMBA D'ÁGUA AO BLOCO	1	1	1	1
50934198	70490347	JUNTA DA CARÇAÇA AO BLOCO	1	1	1	1
50934616	70490373	JUNTA DO TUBO DE SAÍDA DO ESCAPAMENTO				2 2
50942198	36856102	JUNTA DA BOMBA DE ÓLEO	1	1	1	1
52111731		JUNTA DA BASE DA TURBINA	2	2		
50946494	36.87M.006	JUNTA DO BALANCEADOR DINÂMICO	1	1	1	1
50948890	70490713	JUNTA DA ENTRADA DE ÓLEO DA TURBINA	1	1	1	1
50950398	70490345	JUNTA SUPERIOR DO TERMOSTATO	1	1	1	1
50950890	70490314	JUNTA DA SAÍDA DE ÓLEO DA TURBINA	1	1	1	1
50951490	36832135	JUNTA DA FLANGE DO TUBO DE LUBRIFICAÇÃO	1	1	1	1
50954290	70490329	JUNTA DO TUBO DE SUCÇÃO DA BOMBA DE ÓLEO TURBO	1	1	1	1
50955198	70490334	JUNTA DA BOMBA D'ÁGUA	1	1	1	1
80977940		KIT DE BORRACHA	1	1	1	1

• VENDE-SE AVULSO

PERKINS P4236/P4248 4 CILINDROS 4.1 LITROS
PERKINS P4236 4 CILINDROS 3.9 LITROS TURBO

APLICAÇÃO



P4236/4248 4.1L - MASSEY FERGUSON TRACTOR MF 265 1984/00 ; MF275 1975/98 ; MF 272 1991/01 ; MF 290 1977/94

P4236 3.9L TURBO - MASSEY FERGUSON TRACTOR MF 292 1986/93

PERKINS P4236/P4248 4 CILINDROS 4.1 LITROS
PERKINS P4236 4 CILINDROS 3.9 LITROS TURBO

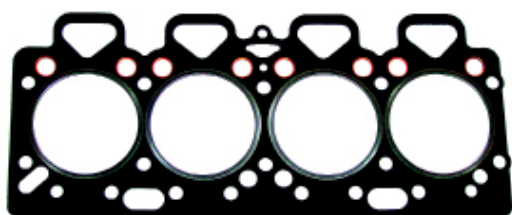

50965504



50918655



50924890

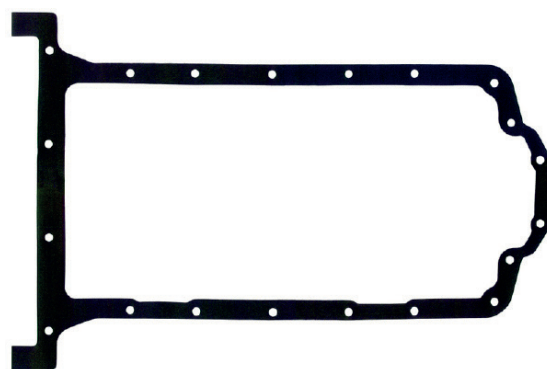

50925390



50955198



50931998



50920898



50925790



50918398



50944630

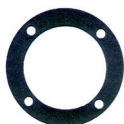

50911498



50946494

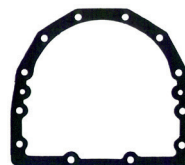

50934198



50925590



50930198



50925698



50951490



50913298



50925990

PERKINS P4236/P4248 4 CILINDROS 4.1 LITROS
 PERKINS P4236 4 CILINDROS 3.9 LITROS TURBO



52111731



50926698



50916098

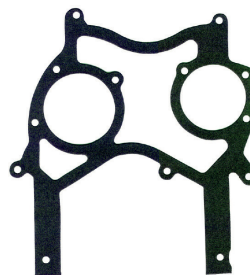

50918798



50948890



50954290



50950890



50950398



50926298



50917996



50944730



50944430



50925890



50934616



50951630



50926016



50942198



50926498



50926198



50926598



50931757



50923498



RE01972S



RE01050S



50924412



RE02590F

80977940 KIT DE BORRACHA		
Nº ABR	DESCRIÇÃO	QTD
	BASTÃO DE BORRACHA 5,33X18,8 MM	2
	VEDADOR DO BICO INJETOR	4
	VEDADOR 6,0X10,5X6,0 MM	1
	VEDADOR 47,0X2,6 MM	1

Nº JOGO		DESCRIÇÃO			
60916151	JOGO DE JUNTAS COMPLETO 4236/4248 SEM RETENTORES		1		
70916151	JOGO DE JUNTAS COMPLETO 4236/4248 COM RETENTORES		2		
70193031	JOGO DE JUNTAS SUPERIOR 4236/4248 COM RETENTORES		3		
70930051	JOGO DE JUNTAS SUPERIOR 4236/4248 COM RETENTORES		4		
Nº ABR	Nº ORIGINAL	DESCRIÇÃO			
RE02590F		RETENTOR DA HASTE DE VÁLVULAS	8	8	8
50050567	70730023	GAXETA			
50911498	70490402	JUNTA DA TAQUÍMETRO			1 1
50913298	70490377	JUNTA DA CONEXÃO ACIO ARR*			1 1
50916098	70490063	JUNTA BOMBA INJETORA			1 1
50917996	70490800	JUNTA DA COLETOR DE TRÁS DA ADMISSÃO	1		1 1
50918398	70490379	JUNTA DA TAMPA TRÁS CABEÇOTE	1	1	1 1
50918655	70490149	JUNTA DA TAMPA DE VÁLVULAS	1	1	1 1
50918798	70490368	JUNTA DA TAMPA DE TRÁS DISTRIBUIÇÃO			1 1
50920898	36866722	JUNTA DA BOMBA ÓLEO			1 1
50923498	70490385	JUNTA DA CAIXA DISTRIBUIÇÃO			1 1
50924412	70490414	JUNTA DA GAXETA ESCAPAMENTO	1	1	1 1
50924890	70490134	JUNTA DA TAMPA DISTRIBUIÇÃO			
50925390	70490312	JUNTA DA CARTER			1 1
50925590	36817136	JUNTA DA CARÇAÇA BLOCO			1 1
50925698	70490378	JUNTA DA ACIO TAQUIMETRO			1 1
50925790	70490408	JUNTA DA TERMOSTATO	1		1 1
50925890	70490796	JUNTA DA COLETOR ADMISSÃO FRONTAL	1		1 1
50925990	70490799	JUNTA DA COLETOR ADMISSÃO CENTRAL	1		1 1
50926016	36862134	JUNTA DA COLETOR ESCAPAMENTO	2		2 2
50926198	70490380	JUNTA DA CONEXÃO ÁGUA	1		1 1
50926298	70926298	JUNTA DA TAMPA BOCAL			1 1
50926498	70490383	JUNTA DA FILTRO DE ÓLEO			1 1
50926598	70490341	JUNTA DA CORPO BOMBA ÁGUA		1	1 1
50926698	70490316	JUNTA DA BOMBA ALIMENTADORA			1 1
50930198	70490267	JUNTA DA CARÇAÇA TERMOSTÁTICA	1		1 1
50931757	36825107	JUNTA			1 1
50931998	70490412	JUNTA DA BOMBA ÁGUA			1 1
50932090	70490100	JUNTA DA BOMBA INJETORA			1 1
50932598	70490386	JUNTA DA PLACA ALIVIO			1 1
50934198	70490347	JUNTA DA COBERTA DO RETENTOR			1 1
50934616	70490373	JUNTA DA SAÍDA ESCAPAMENTO			1 1
50936998	70490365	JUNTA DA TAMPA DISTRIBUIÇÃO	2		2 2
50937398	70490145	JUNTA DA CORPO DIANTEIRO			1 1
50942095	70490746	JUNTA DA BOMBA INJETORA			1 1
50942198	36856102	JUNTA DA BOMBA ALIMENTADORA			1 1
50942270	70490267	JUNTA DO ADAPTADOR DO EXAUSTOR			1 1
50944430	3688C003	JUNTA DA COLETOR ADMISSÃO FRONTAL			1 1
50944630	3688C002	JUNTA DA COLETOR ADMISSÃO CENTRAL		1	
50944730	3688C001	JUNTA DA COLETOR ADMISSÃO TRASEIRO		1	
50945032	36885008	JUNTA DA BASE TURBINA		1	
50946494	3687M006	JUNTA DA BLOCO		1	
50950098	70490398	JUNTA DA TUBO PESCADOR			
50950398	70490345	JUNTA DA CONEXÃO SAÍDA ÁGUA			
50950890	70490314	JUNTA DA TURBINA	1	1	1 1
50951490	70490376	JUNTA DA TUBO SUCÇÃO		1	
50951630	3688C007	JUNTA DA COLETOR DO ESCAPAMENTO			
50952790	70490317	JUNTA DA TURBINA		2	
50954298	70490329	JUNTA DA FILTRO DE ÓLEO		1	
50955198	70490334	JUNTA DA CONEXÃO DA BOMBA DE ÁGUA			1 1
50965504	70490304	JUNTA DA CABEÇOTE			
80977940		KIT DE ARRUELAS E BORRACHAS	1	1	1 1
RE01050S		RETENTOR DA POLIA	1	1	1 1
RE01972S		RETENTOR TRASEIRO		1	

4236/4248

APLICAÇÃO



PERKINS P4203 INJEÇÃO INDIRETA 4 CIL 3.3L

FORD TRACTOR 8BR 1961/67

PERKINS P4203 INJEÇÃO INDIRETA 4 CIL 3.3L

MASSEY FERGUSON TRACTOR MF 65 1965/82 CBT TRACTOR 1000 1975/...CASE TRACTOR 580E 1972/85

4236/4248

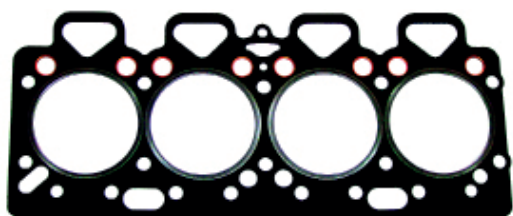

50965504



50918655



50924890

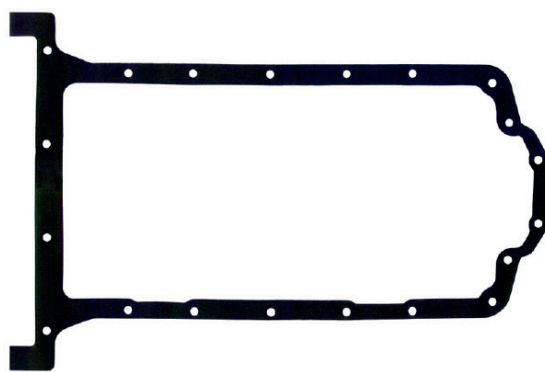

50925390

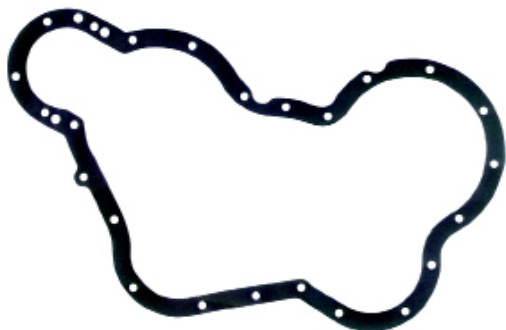

50936998

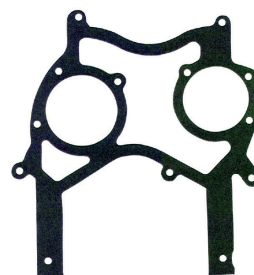

50918798



50955198



50931998



50920898



50925790



5091839



50945032



50944630



50925990



50911498

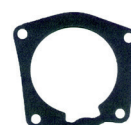

50942270

4236/4248



50932598



50937398



5094694

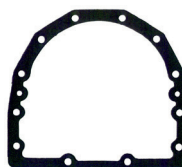

50934198



50925590



50930198



50942095



50926698



50932090



50916098



50925698



50950098



58311632



58317447



58317447



50952790



58318467



58311632



58317447



58317447



50917996



50944730



50944430



50925890



50934616



50951630



50926016



50942108



50922698



50926498



50926198



50926598



50931757



59331757



50923498



RE01972S



RE01050S



50924412



50050567



RE02590F

80903426		KIT DE BORRACHA	
Nº ABR	Nº ORIGINAL	DESCRIÇÃO	QTD
50937620	70920081	ARRUELA BICO INJETORA 10,0X19,2X2,0 MM	4
50962240	70730019	VEDADOR DA PORTA INJETORA	4
50972641	32811408	VEDADOR DA PLACA INTERMEDIARIA	2
50963941	33811113	ANEL DO TUBO LUBRIFICANTE DO CABEÇOTE	1

Nº JOGO		DESCRIÇÃO				
60910151		JOGO DE JUNTAS COMPLETO 4236/Q20B SEM RETENTORES				1
70910151		JOGO DE JUNTAS COMPLETO 4236/Q20B COM RETENTORES				2
60930051		JOGO DE JUNTAS SUPERIOR 4236/Q20B SEM RETENTORES				3
70930051		JOGO DE JUNTAS SUPERIOR 4236/Q20B COM RETENTORES				4
Nº ABR	Nº ORIGINAL	DESCRIÇÃO				
RE02590F		RETENTOR DA HASTE DE VÁLVULAS	8			8
50917996	70490800	JUNTA DO COLETOR DE ADMISSÃO TRASEIRO	1	1	1	1
50918398	70490379	JUNTA DA TAMPA DE TRASEIRO CABEÇOTE	1	1	1	1
50918655	70490149	JUNTA DA TAMPA DE VÁLVULA	1	1	1	1
50918798	70490368	JUNTA DA TAMPA DO TRASEIRO				1 1
50922198	70490352	JUNTA				1 1
50922398	70490370	JUNTA DO CARTER				1 1
50922498	70490375	JUNTA DO FILTRO DE ÓLEO				1 1
50922698	70490409	JUNTA DA PLACA DO BLOCO				1 1
50923398	70490407	JUNTA DA TAMPA DE DISTRIBUIÇÃO				1 1
50923498	70490385	JUNTA DA CAIXA DE DISTRIBUIÇÃO				1 1
50924412	70490414	GAXETA DO ESCAPAMENTO	1	1	1	1
50925698	70490378	JUNTA DO TAQUIMETRO				1 1
50925790	70490408	JUNTA DO TERMOSTATO DO CABEÇOTE	1	1	1	1
50925890	70490796	JUNTA DO COLETOR DE ADMISSÃO FRONTAL	1	1	1	1
50925990	70490799	JUNTA DO COLETOR DE ADMISSÃO CENTRAL	1	1	1	1
50926016	70490319	JUNTA DO COLETOR DO ESCAPAMENTO	2	2	2	2
50926198	70490380	JUNTA DA CONEXÃO DA SAÍDA DE ÁGUA	1	1	1	1
50926498	70490383	JUNTA DO FILTRO DE ÓLEO				1 1
50926698	70490316	JUNTA DA BOMBA ALIMENTADORA				1 1
50930198	70490746	JUNTA DA CARÇAÇA TERMOSTATO	1	1	1	1
50931757	36825107	JUNTA				1 1
50931998	70490412	JUNTA DA BOMBA DE ÁGUA				1 1
50932090	70490100	JUNTA DA BOMBA INJETORA				1 1
50932598	70490328	JUNTA DA PLACA DE ALIVIO				1 1
50934198	70490347	JUNTA DA COBERTA DO RETENTOR				1 1
50934616	70490373	JUNTA DA SAÍDA DO ESCAPAMENTO	2	2	2	2
50936898	70490328	JUNTA DA ACOPLAMENTO DA BOMBA INJETORA				1 1
50937398	70490145	JUNTA DO CORPO DIANTEIRO				1 1
50942095	70490315	JUNTA DA BOMBA INJETORA DO ADAPTADOR				1 1
50942198	36856102	JUNTA DA BOMBA ALIMENTADORA				1 1
50942270	70490267	JUNTA DO ADAPTADOR DO EXAUSTOR				1 1
50949698	70490339	JUNTA DO SUPORTE DA BOMBA DE ÁGUA				1 1
50949753	70490178	JUNTA DO CARTER				1 1
50950098	70490398	JUNTA DO TUBO DO PESCADOR	1	1	1	1
50950398	70490345	JUNTA DA CONEXÃO DA SAÍDA DE ÁGUA	1	1	1	1
50965504	70490304	JUNTA DO CABEÇOTE	1	1	1	1
80977940		KIT DE ARRUELAS E BORRACHAS				1 1
80979326		KIT DE ARRUELAS E BORRACHAS				1
RE01050S		RETENTOR DA POLIA				1
RE01972S		RETENTOR TRASEIRO				

• VENDE-SE AVULSO

4236/Q20B

APLICAÇÃO



PERKINS P4203 INJEÇÃO INDIRETA 4 CILINDROS 3.3LITROS

FORD TRACTOR 8BR 1961/67

PERKINS P4203 INJEÇÃO INDIRETA 4 CILINDROS 3.3LITROS

MASSEY FERGUSON TRACTOR MF 65 1965/82 CBT TRACTOR 1000 1975/...CASE TRACTOR 580E 1972/85

4236/Q20B

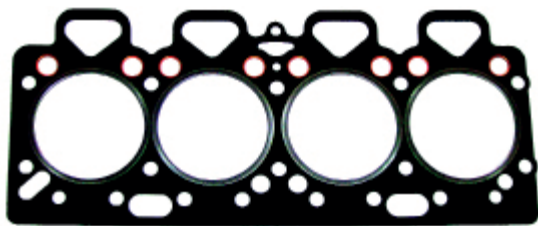

50965504

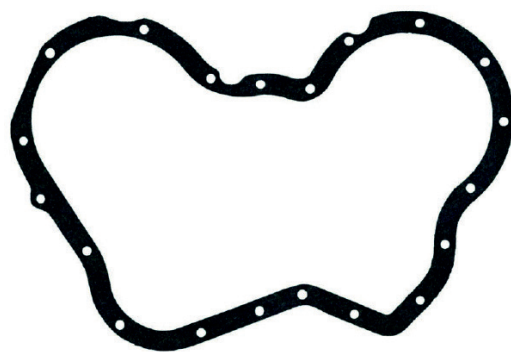

50918655

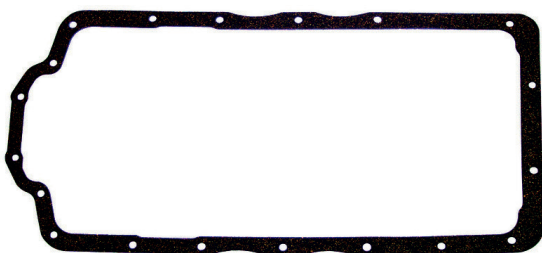

50965504



50918655

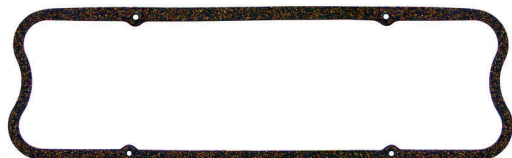

50915290

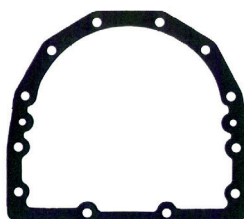

50923990

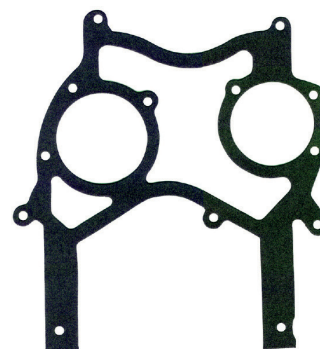

50914490

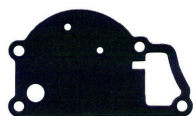

50923816

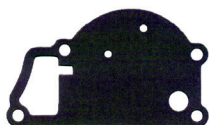

50910590



50916098



50914396



50923816

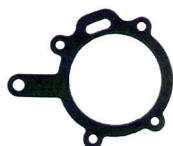

50910590



50916098



50914396

4236/Q20B



50923816



50910590



50916098



50914396



50923816



50910590



50916098



50914396



50923816



50910590



50916098



50914396



50923816



50910590



50916098



50914396



50923816



50910590



50916098



50914396



50923816



50910590



50916098



50914396



50923816

80979326 KIT DE BORRACHA D229 4 CILINDROS TURBO		
Nº ABR	DESCRIÇÃO	QTD
50028725	ARRUELA DE ALUMÍNIO 8,0X12,0X1,0 MM	1
50026929	ARRUELA DE ALUMÍNIO 14,0X18,0X1,5 MM	1
50023329	ARRUELA DE ALUMÍNIO 16,0X22,0X1,5 MM	4
50020025	ARRUELA DE ALUMÍNIO 16,0X20,0X1,5 MM	7
50015529	ARRUELA DE ALUMÍNIO 10,0X16,0X1,5 MM	14
50012929	ARRUELA DE ALUMÍNIO 22,0X27,0X2,0 MM	8
50009923	ARRUELA DE COBRE 7,2X15,2X2,0 MM	8

80977940 KIT DE BORRACHA D229 4 CILINDROS TURBO			
Nº ABR	Nº ORI	DESCRIÇÃO	QTD
50937620	70920081	ARRUELA BICO INJETORA 10,0X19,2X2,0 MM	4
50962240	70730019	VEDADOR DA PORTA INJETORA	4
50972641	32811408	VEDADOR DA PLACA INTERMEDIARIA	2
50963941	33811113	ANEL DO TUBO LUBRIFICANTE DO CABEÇOTE	1

Nº JOGO		DESCRIÇÃO						
60914763	JOGO DE JUNTAS COMPLETO P10066/6T ASPIRADO/TURBO SEM RETENTORES		1					
70914763	JOGO DE JUNTAS COMPLETO P10066/6T ASPIRADO/TURBO COM RETENTORES		2					
60934763	JOGO DE JUNTAS SUPERIOR P10066/6T ASPIRADO/TURBO SEM RETENTORES		3					
60914053	JOGO DE JUNTAS COMPLETO P10044/4T ASPIRADO/TURBO SEM RETENTORES		4					
70914053	JOGO DE JUNTAS COMPLETO P10044/4T ASPIRADO/TURBO COM RETENTORES		5					
60934053	JOGO DE JUNTAS SUPERIOR P10044/4T ASPIRADO/TURBO SEM RETENTORES		6					
Nº ABR	Nº ORIGINAL	DESCRIÇÃO						
50925390	368174007	JUNTA DO CARTER	1	1				
50932831	736882191	JUNTA DO COLETOR DO ESCAPAMENTO	2	2	2	2	2	2
50937620	70920081	ARRUELA	4	4	4	6	6	6
50938030	70490160	JUNTA DO COLETOR DE ADMISSÃO CENTRAL	2	2	2	2	2	2
50939300	3681E037	JUNTA DO CABEÇOTE	1	1	1			
50942941		RETENTOR DA HASTE DE VÁLVULAS	8	8	8	12	12	12
50944532	36866746	JUNTA DO COLETOR DE ESCAPAMENTO	1	1	1	1	1	1
50945032	36885008	JUNTA DA BASE DA TURBINA	1	1	1	1	1	1
50945431	70490161	JUNTA DO COLETOR DE ADMISSÃO	2	2	2	2	2	2
50947090	3681P009	JUNTA DA CAIXA DE DISTRIBUIÇÃO		1	1		1	1
50948067	3681P011	JUNTA DA TAMPA DE DISTRIBUIÇÃO		1	1		1	1
50949540	70490258	JUNTA DA TAMPA DE VÁLVULAS	1	1	1			
50967840	70920081	JUNTA DO VEDADOR DA PORTA INJETORA	4	4	4	6	6	6
50970150	3681C001	JUNTA DA TAMPA DE VÁLVULAS					1	1
50970290	3382P004	JUNTA DA BOMBA DE ÁGUA		1	1		1	1
50971190	3681H007	JUNTA DO CARTER					1	1
50971400	3681H218	JUNTA DO CABEÇOTE					1	1
50981967	3685N008	JUNTA DO TUBO DO ESCAPAMENTO	1	1	1	1	1	1
50982067	3685R005	JUNTA DO TERMOSTATO	1	1	1	1	1	1
50982167	3685F006	JUNTA DO TERMOSTATO DA CARÇAÇA	1	1	1	1	1	1
50982267	3683H006	JUNTA DA TURBINA	1	1	1	1	1	1
50982367	36832135	JUNTA DA ENTRADA DE ÓLEO	1	1	1	1	1	1
50982467	36832131	JUNTA DA SAÍDA DE ÓLEO	1	1	1	1	1	1
50982567	3686A004	JUNTA DO TERMOSTATO	1	1	1	1	1	1
50982667	3684R004	JUNTA DO FILTRO DE ÓLEO		1	1		1	1
50982767	3687W003	JUNTA DO FILTRO DE ÓLEO		1	1		1	1
50982867	3687Y002	JUNTA DO FILTRO DE ÓLEO		1	1		1	1
50982967		JUNTA DA TAMPA DA TOMADA DA FORÇA		1	1		1	1
50983067	3687H005	JUNTA DA TAMPA DO RETENTOR		1	1		1	1
50983167	36817181	JUNTA DA TAMPA DE INSPEÇÃO		1	1		1	1
50983267	3682H003	JUNTA DO FILTRO DE ÓLEO		1	1		1	1
50983367	368A511	JUNTA DA BOMBA DE ALIMENTADORA		1	1		1	1
50983467	33828108	JUNTA DA BOMBA INJETORA		1	1		1	1
50983567	3686T004/006	JUNTA DO FILTRO DE ÓLEO		1	1		1	1
50983667		JUNTA DO TUBO		1	1		1	1
50983767	36811115	JUNTA DO FILTRO DO RESPIRO DO ÓLEO		1	1		1	1
50983867		JUNTA DO TERMOSTATO		1	1		1	1
50983967	3683N004	JUNTA DA CARÇAÇA DO TERMOSTATO		1	1		1	1
50984067		JUNTA DO TERMOSTATO		1	1		1	1
50984167	36832143	JUNTA DA BOMBA DE ÓLEO		1	1		1	1
RE01050S		RETENTOR DA POLIA		1			1	
RE01972S		RETENTOR TRASEIRO		1			1	

• VENDE-SE AVULSO

1004/10044T/1006/10066T

APLICAÇÃO



PERKINS P4203 INJEÇÃO INDIRETA 4 CILINDROS 3.3LITROS

FORD TRACTOR 8BR 1961/67

PERKINS P4203 INJEÇÃO INDIRETA 4 CILINDROS 3.3LITROS

MASSEY FERGUSON TRACTOR MF 65 1965/82 CBT TRACTOR 1000 1975/...CASE TRACTOR 580E 1972/85

1004/10044T/1006/10066T



50939300

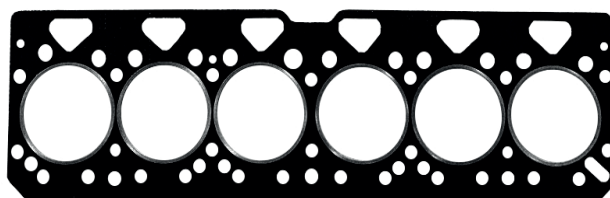

50971400



50949540



50970150

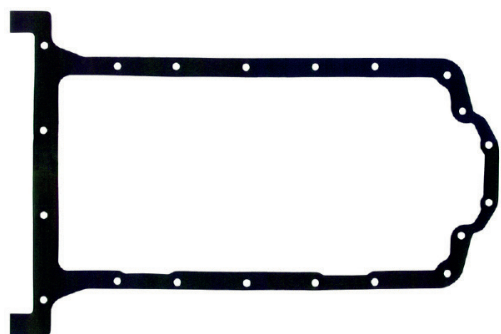

50925390*

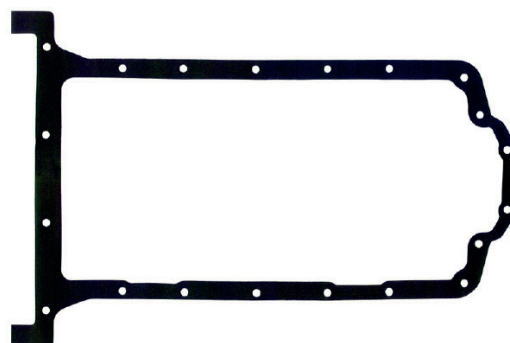

50925390

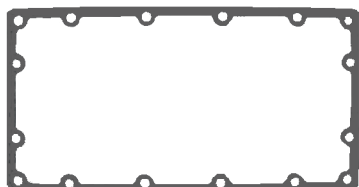

50982667

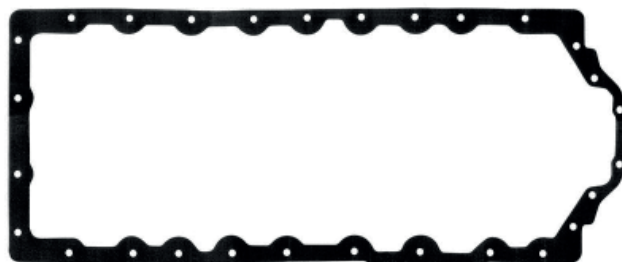

50971190

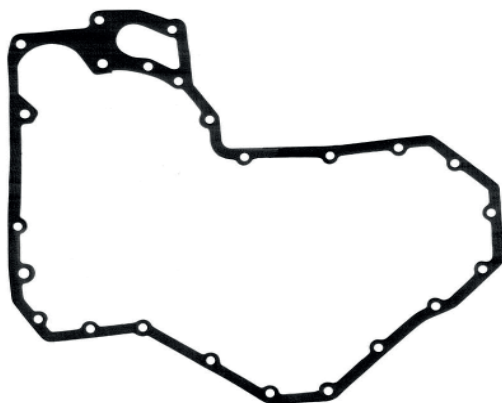

50948067

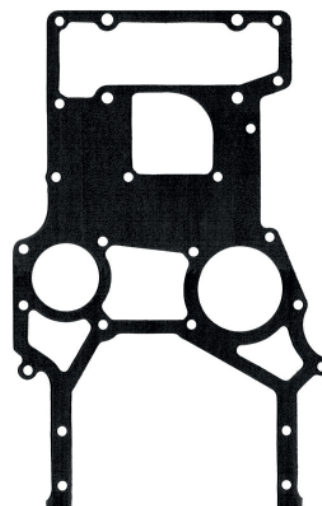

50947090

1004/10044T/1006/10066T

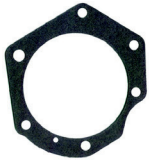

50982967

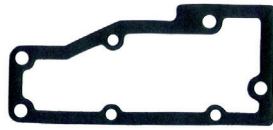

50982167

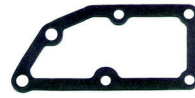

50982167

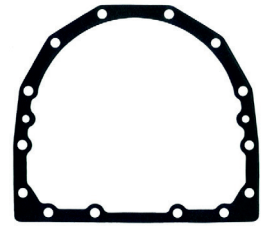

50983067

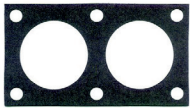

50982567



50945032

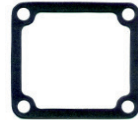

50981967

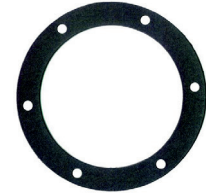

50914396



50983267



50944532



50938030



50983167



50983267



50983367



50982867



50982767



50932831



50945431



50983967



50982367



50983867



50910590



50982467



50982467



50982367



50984167



50916098



50914396



50967840



50937620



50942941

Nº JOGO		DESCRIÇÃO		
60914753		JOGO DE JUNTAS COMPLETO P4000/4000T ASPIRADO/TURBO SEM RETENTORES	1	
70914753		JOGO DE JUNTAS COMPLETO P4000/4000T ASPIRADO/TURBO COM RETENTORES	2	
70934751		JOGO DE JUNTAS SUPERIOR P4000/4000T ASPIRADO/TURBO COM RETENTORES COM HASTE DE VÁLVULA	3	
Nº ABR	Nº ORIGINAL	DESCRIÇÃO		
RE02590F		RETENTOR DA HASTE DE VÁLVULAS	2	2
50913298	70490377	JUNTA DO TUBO DE SUÇÃO DA BOMBA	1	1
50917996	70490800	JUNTA DO COLETOR DE ADMISSÃO	1	1
50924890	70490311	JUNTA DA TAMPA DE DISTRIBUIÇÃO	2	2
50925390	3681H007	JUNTA DO CARTER	1	1
50925698	70490378	JUNTA	1	1
50925790	70490408	JUNTA DA CARÇAÇA DO TERMOSTATO	1	1
50925890	70490796	JUNTA DO COLETOR DE ADMISSÃO FRONTAL	1	1
50925990	70490799	JUNTA DO COLETOR DE ADMISSÃO CENTRAL	1	
50926198	70460380	JUNTA DO COTOVELO DA SAÍDA DE ÁGUA DO RESFRIADOR	1	1
50926298	70490320	JUNTA DO BOCAL DO ABASTECIMENTO	1	1
50926498	70490383	JUNTA DA FLANGE DO FILTRO DE ÓLEO	1	1
50926598	70490341	JUNTA DA BOMBA DE ÁGUA	1	1
50931757	36825107	JUNTA DA TAMPA DO TAQUIMETRO	2	2
50931996	70490412	JUNTA DO SUPORTE DA BOMBA DE ÁGUA	1	1
50934198	70490347	JUNTA DA TAMPA TRASEIRA	1	1
50936898	70490328	JUNTA DO ADAPTADOR DA BOMBA INJETORA	1	1
50942198	36856102	JUNTA DA BOMBA ALIMENTADORA	1	1
50945032	36885008	JUNTA DA BASE DA TURBINA	1	1
50946494	3687M006	JUNTA DO BLOCO DO BALANCEADOR DIANTEIRO	1	1
50948890	70490713	JUNTA DA ENTRADA DO ÓLEO DA TURBINA	1	1
50949090	70490369	JUNTA DA CAIXA DE DISTRIBUIÇÃO	1	1
50949540	70490258	JUNTA DA TAMPA DE VÁLVULAS	1	1
50950398	70490345	JUNTA DA CARÇAÇA DE VÁLVULAS DO TERMOSTATO	1	1
50950890	70490314	JUNTA DA SAIDA DO ÓLEO DA TURBINA	1	1
50951490	70490376	JUNTA DA FLANGE DO TUBO DE ALIMENTAÇÃO	1	
50951630	3688C007	JUNTA DA COL ESCAPAMENTO	1	1
50953304	70490415	JUNTA DA CABEÇOTE	1	1
50954298	70490375	JUNTA DA TUBO SUÇÃO ÓLEO	1	1
50955198	70490334	JUNTA DA CONEXÃO DA BOMBA DE ÁGUA		
50971017	70490283	JUNTA DA CARÇAÇA DA TURBINA		
50918398	70490379	JUNTA DA TAMPA TRASEIRA DO CABEÇOTE		
60014756		KIT DE ARRUELAS E BORRACHAS		
RE01050S		RETENTOR DA POLIA		
RE01972S		RETENTOR TRASEIRO		

• VENDE-SE AVULSO

P4000/P4000T

APLICAÇÃO



PERKINS P4203 INJEÇÃO INDIRETA 4 CILINDROS 3.3LITROS

FORD TRACTOR 8BR 1961/67

PERKINS P4203 INJEÇÃO INDIRETA 4 CILINDROS 3.3LITROS

MASSEY FERGUSON TRACTOR MF 65 1965/82 CBT TRACTOR 1000 1975/...CASE TRACTOR 580E 1972/85

P4000/P4000T

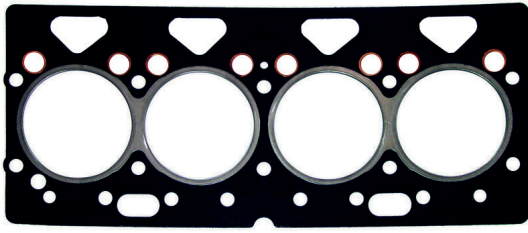

50953304

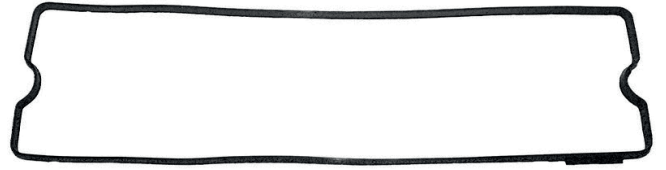

50949540

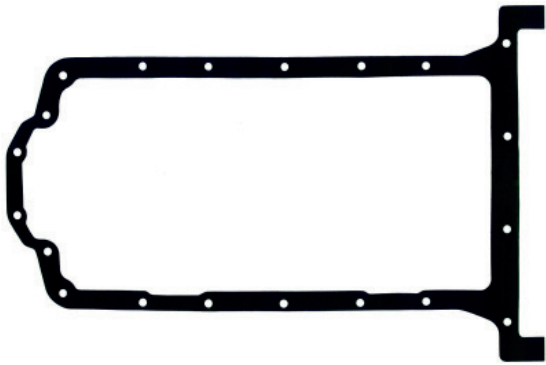

50925990



50924890

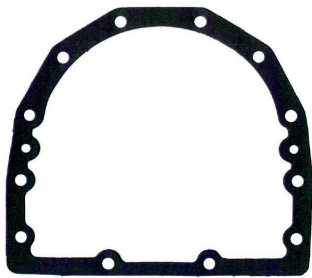

50934198



50949090



50946494



50918398



50925790

P4000/P4000T



50951630



50926298



50925990



50945032



50955198



50931996



50951490



50948890



50950890



50913298



50954298



50925698



50917996





50926198



50926498



50936898



50942198



50950398



50926598



50931757



50971017



RE01972S



RE01050S



RE02590F

60014756 KIT DE BORRACHA D229 4 CILINDROS TURBO		
Nº ABR	DESCRIÇÃO	QTD
50012325	ARRUELA DE ALUMÍNIO 8,0X12,0X1,0 MM	4
50016529	ARRUELA DE COBRE 14,0X18,0X1,5 MM	5
50937620	ARRUELA DE COBRE 16,0X22,0X1,5 MM	2
50010123	ARRUELA DE COBRE 16,0X20,0X1,5 MM	9
50917220	ARRUELA DE COBRE 10,0X16,0X1,5 MM	4
50963941	ANEL DO TUBO DE LUBRIFICANTE CABEÇOTE	1

Nº JOGO		DESCRIÇÃO			
60914733	JOGO DE JUNTAS COMPLETO S4/S4T SEM RETENTORES		1		
70914733	JOGO DE JUNTAS COMPLETO S4/S4T COM RETENTORES		2		
70934731	JOGO DE JUNTAS SUPERIOR S4/S4T COM RETENTORES COM HASTE VÁLVULAS		3		
Nº ABR	Nº ORIGINAL	DESCRIÇÃO			
RE02590F		RETENTOR DA HASTE DE VÁLVULAS	8	8	
50918398	70490379	JUNTA DA TAMPA TRASEIRA DO CABEÇOTE	1	1	1
50923498	70490385	JUNTA DA BOMBA DO VÁCUO		1	1
50925790	70490408	JUNTA DA CARÇAÇA DO TERMOSTATO	1	1	1
50934198	70490347	JUNTA DA TAMPA TRASEIRA		1	1
50936898	70490328	JUNTA DO ADAPTADOR DA BOMBA INJETORA		1	1
50942095	70490315	JUNTA DA BOMBA INJETORA		1	1
50942198	36856102	JUNTA DA CURVA DE ADMISSÃO		1	1
50943298	70490257	JUNTA DO FILTRO DE ÓLEO	1	1	1
50943398	70490335	JUNTA DA TAMPA DA CAIXA DE DISTRIBUIÇÃO		1	1
50943598	70490413	JUNTA DA ADMISSÃO FRONTAL		1	1
50944430	3688C003	JUNTA DA ADMISSÃO	1	1	1
50944630	3688C002	JUNTA DA ADMISSÃO TRASEIRA	1	1	1
50944730	3688C001	JUNTA DA BASE DA TURBINA	1	1	1
50945032	36885008	JUNTA DA CONEXÃO DO TERMOSTATO	1	1	1
50946398	70490337	JUNTA DA ENTRADA DE ÓLEO DA TURBINA	1	1	1
50948890	70490713	JUNTA DA BOMBA DE ÁGUA	1	1	1
50948998	70490336	JUNTA DA CAIXA DE DISTRIBUIÇÃO		1	1
50949090	7049090*	JUNTA DA TAMPA DE VÁLVULAS		1	1
50949540	70490358	JUNTA DO SUPORTE DA BOMBA DE ÁGUA	1	1	1
50949698	70490339	JUNTA DO CARTER		1	1
50949753	70490178	JUNTA DO PESCADOR		1	1
50950098	70490398	JUNTA DA SAÍDA DO ÓLEO VIRABREQUIM		1	1
50950890	70490314	JUNTA DO COLETOR DE ESCAPAMENTO	1	1	1
50951630	3688C007	JUNTA DO CABEÇOTE	2	2	2
50951832	3688A009	KIT DE BORRACHA	1	1	1
50953304	70490415	KIT DE ARRUELA	1	1	1
80964541		RETENTOR DA POLIA	1	1	1
80978020		RETENTOR TRASEIRO		1	1
RE01050S		RETENTOR DO VIRABREQUIM DIANTEIRO		1	
RE01972S		RETENTOR DO VIRABREQUIM TRASEIRO		1	

• VENDE-SE AVULSO

S4/S4T

APLICAÇÃO



PERKINS P4203 INJEÇÃO INDIRETA 4 CILINDROS 3.3LITROS

FORD TRACTOR 8BR 1961/67

PERKINS P4203 INJEÇÃO INDIRETA 4 CILINDROS 3.3LITROS

MASSEY FERGUSON TRACTOR MF 65 1965/82 CBT TRACTOR 1000 1975/...CASE TRACTOR 580E 1972/85

S4/S4T

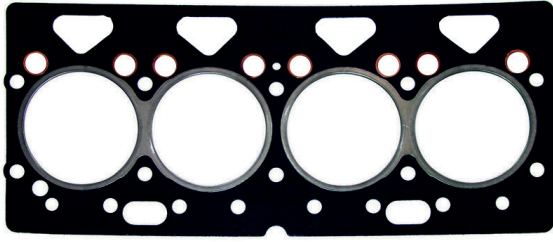

50953304



50949540

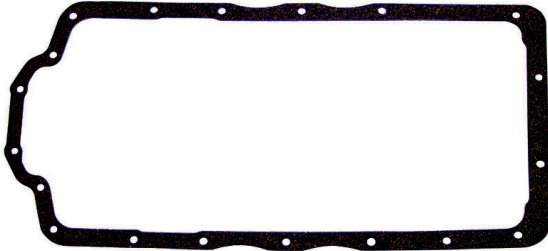

50949753

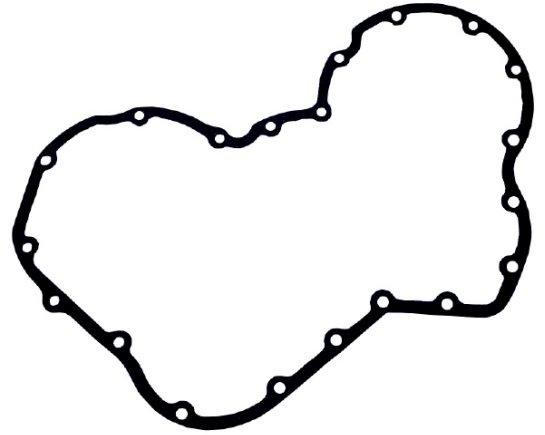

50943598

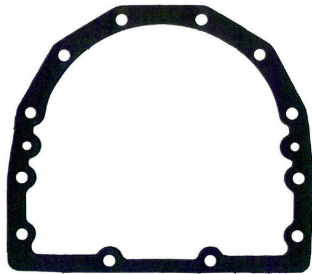

50934198

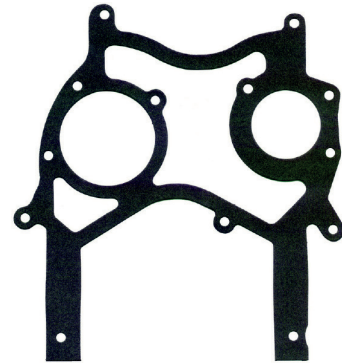

50949090

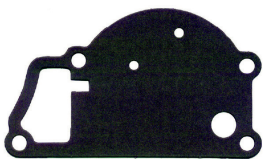

50949698



50948998

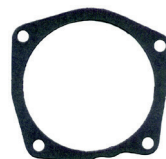

50923498



50945032

S4/S4T



50951630



50944630



50944730



50944430



50950890



50948890



50950098



50942095

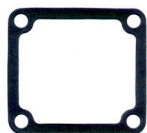

50943298



50918398



50925790



50943398

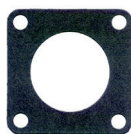

50946398



50936898

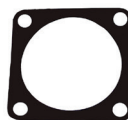

50951832



50942198



RE01972S



RE01050S



RE02590F

80964541 KIT DE BORRACHA D229 4 CILINDROS TURBO			
Nº ABR	Nº ORI	DESCRIÇÃO	QTD
50964141	70590007	ANEL BORRACHA DO CÂRTER	2
50964041	33817132	VEDADOR DA PORTA INJETORA	4
50964241	70590008	VEDADOR DO BICO INJETOR	4
50963941	33811113	ANEL DO TUBO LUBRIFICANTE DO CABEÇOTE	1
50964341	70590009	VEDADOR DA TAMPA DA CAIXA DISTRIBUIÇÃO	1
50964441	70590011	VEDADOR DA TAMPA DO CABEÇOTE	1

80978020 KIT DE BORRACHA D229 4 CILINDROS TURBO			
Nº ABR	DESCRIÇÃO		QTD
5009923	ARRUELA DE COBRE	6,2X10,2X1,0 MM	6
50011228	ARRUELA DE ALUMÍNIO	8,0X12,0X1,0 MM	2
	ARRUELA DE COBRE	8,0X12,0X2,0 MM	4
50021129	ARRUELA DE ALUMÍNIO	14,0X18,0X1,5 MM	8
50023329	ARRUELA DE ALUMÍNIO	16,0X22,0X1,5 MM	3
50023629	ARRUELA DE ALUMÍNIO	16,0X22,0X1,5 MM	4
50015529	ARRUELA DE ALUMÍNIO	10,0X16,0X1,5 MM	4
50028725	ARRUELA DE ALUMÍNIO	22,0X27,0X2,5 MM	2
50011024	ARRUELA DE COBRE	10,0X15,2X2,0 MM	4

Nº JOGO		DESCRIÇÃO		
60914773		JOGO DE JUNTAS COMPLETO HS 2.5 SEM RETENTORES		1
70914773		JOGO DE JUNTAS COMPLETO HS 2.5 COM RETENTORES		2
60934773		JOGO DE JUNTAS SUPERIOR HS 2.5 SEM RETENTORES		3
70934773		JOGO DE JUNTAS SUPERIOR HS 2.5 COM RETENTORES COM HASTE VÁLVULA		4
Nº ABR	Nº ORIGINAL	DESCRIÇÃO		
RE02396F		RETENTOR DA HASTE DE VÁLVULAS	8	8
RE05239F		RETENTOR TRASEIRO		1
509100650		JUNTA DO MANCAL		2 2
50946877	ERR4861	JUNTA DA TAMPA DO RETENTOR TRASEIRO		1 1
50947267	ERR1653	JUNTA DO DRENO DE ÓLEO		1 1
50947367	ERR1278	JUNTA DA BOMBA DE ÁGUA DO BLOCO		1 1
50947467	ERR2018	JUNTA DA BOMBA DO COMBUSTIVEL		1 1
50947567	ERR4860	JUNTA DA TAMPA FRONTAL DO BLOCO		1 1
50947667	ERR2027	JUNTA DA BOMBA DO VÁCUO		1 1
50947767	ERR2023	JUNTA DA BOMBA INJETORA		1 1
50947867	ERR1516	JUNTA DA TAMPA DE INSP DA DISTRIBUIÇÃO		1 1
50947967	ERR3284	JUNTA DA CARÇAÇA DA BOMBA DE ÁGUA		1 1
50948167	ERR2026	JUNTA DO FILTRO DO CABEÇOTE		1 1
50948267	ERR3490	JUNTA DO TERMOSTATO	1 1	1 1
50948367	ERR3283	JUNTA DO FILTRO DE ÓLEO		1 1
50948467	ERR4120	JUNTA DA CAIXA DE DISTRIBUIÇÃO		1 1
50948567		JUNTA DO RADIADOR DE ÓLEO		1 1
50962400	ERR5260	JUNTA DO CABEÇOTE		
50963644	70490309	JUNTA DA TAMPA DE VÁLVULAS	1 1	1 1
50965300	70490307	JUNTA DO CABEÇOTE	1 1	1 1
50977147	70490308	JUNTA DO COLETOR DE ADMISSÃO	1 1	1 1
80964650	70490300	JUNTA DO CARTER		1 1
80966826		KIT DE ARRUELAS		1 1
80967226		KIT DE ARRULA DO JOGO SUPERIOR	1 1	
RE05352S		RETENTOR ARVOVE DIAANTEIRO		1
RE05353S		RETENTOR DO EIXO DO COMANDO		1
RE05413N		RETENTOR DA GUARDA DO PÓ DA DISTRIBUIÇÃO		1

● VENDE-SE AVULSO

HS 2.5

APLICAÇÃO



FORD RANGER TD 1995/...

FORD RANGER TD 2.8 2002/...

CHEVROLET S10 TDI/BLAZER TDI 1995/...

LAND ROVER DEFENDER 90/110/130/RANGE ROVER/DISCOVERY TDI 1994/98

MERCEDES SPRINTER TDI 1997/...

FORD RANGER TD 2.8 2002/...

HS 2.5



50977147



50963644



RE05239F

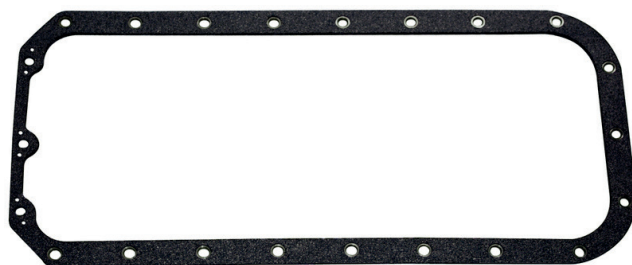

50918655



50947567



50948467



50947367



50947967



50947767



50946877

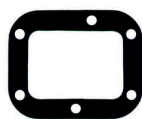

50948167



50947667



50948267



50948367

HS 2.5



50947267



50947467



50947867



509100650



50948567



RE05353S



RE05352S



RE05353S



RE02396F

80966826 KIT DE BORRACHA D229 4 CILINDROS TURBO		
Nº ABR	DESCRIÇÃO	QTD
50092529	ARRUELA DE ALUMÍNIO 12,0X18,0X1,5 MM	4
50009923	ARRUELA DE COBRE 6,4X10,0X1,0 MM	1
50011020	ARRUELA DE COBRE 7,3X15,2X1,0 MM	4
50011024	ARRUELA DE COBRE 7,3X15,2X2,0 MM	4
50070329	ARRUELA DE ALUMÍNIO 18,5X22,0X1,5 MM	7
50011228	ARRUELA DE ALUMÍNIO 8,0X12,0X1,0 MM	2
50022229	ARRUELA DE ALUMÍNIO 14,6X20,8X1,5 MM	6
50021529	ARRUELA DE ALUMÍNIO 14,0X20,0X1,5 MM	5
50026729	ARRUELA DE ALUMÍNIO 20,0X26,0X1,5 MM	8

80967226 KIT DE BORRACHA D229 4 CILINDROS TURBO		
Nº ABR	DESCRIÇÃO	QTD
50011020	ARRUELA DE COBRE 7,3X15,2X1,0 MM	4
50011024	ARRUELA DE COBRE 7,3X15,2X2,0 MM	4

Nº JOGO		DESCRIÇÃO		
60914873		JOGO DE JUNTAS COMPLETO HS 2.8 SEM RETENTORES		1
70914873		JOGO DE JUNTAS COMPLETO HS 2.8 COM RETENTORES		2
60934873		JOGO DE JUNTAS SUPERIOR HS 2.8 SEM RETENTORES		3
70934873		JOGO DE JUNTAS SUPERIOR HS 2.8 COM RETENTORES		4
Nº ABR	Nº ORIGINAL	DESCRIÇÃO		
RE02396F		RETENTOR DA HASTE DE VÁLVULAS	8	8
RE05239F		RETENTOR TRASEIRO		1
509100650		JUNTA DO MANCAL		2 2
50946877	ERR4861	JUNTA DA TAMPA DO RETENTOR TRASEIRO		1 1
50947267	ERR1653	JUNTA DO DRENO DE ÓLEO		1 1
50947367	ERR1278	JUNTA DA BOMBA DE ÁGUA DO BLOCO		1 1
50947467	ERR2018	JUNTA DA BOMBA DO COMBUSTIVEL		1 1
50947567	ERR4860	JUNTA DA TAMPA FRONTAL DO BLOCO		1 1
50947667	ERR2027	JUNTA DA BOMBA DO VÁCUO		1 1
50947767	ERR2023	JUNTA DA BOMBA INJETORA		1 1
50947867	ERR1516	JUNTA DA TAMPA DE INSP DA DISTRIBUIÇÃO *		1 1
50947967	ERR3284	JUNTA DA CARÇAÇA DA BOMBA DE ÁGUA		1 1
50948167	ERR2026	JUNTA DO FILTRO DO CABEÇOTE	1 1	1 1
50948267	ERR3490	JUNTA DO TERMOSTATO		1 1
50948367	ERR3283	JUNTA DO FILTRO DE ÓLEO		1 1
50948467	ERR4120	JUNTA DA CAIXA DE DISTRIBUIÇÃO		1 1
50948567		JUNTA DO RADIADOR DE ÓLEO		1 1
50962400	ERR5260	JUNTA DO CABEÇOTE	1 1	1 1
50963644	70490309	JUNTA DA TAMPA DE VÁLVULAS	1 1	1 1
50965300	70490307	JUNTA DO CABEÇOTE		
50977147	70490308	JUNTA DO COLETOR DE ADMISSÃO	1 1	1 1
80964650	70490300	JUNTA DO CARTER		1 1
80966826		KIT DE ARRUELAS		1 1
80967226		KIT DE ARRUELAS DO JOGO SUPERIOR		
RE05352S		RETENTOR ARVOVE DIANTEIRO		1
RE05353S		RETENTOR DO EIXO DO COMANDO		1
RE05413N		RETENTOR DA GUARDA DO PÓ DA DISTRIBUIÇÃO		1

● VENDE-SE AVULSO

HS 2.8

APLICAÇÃO

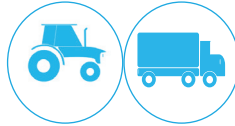

PERKINS P6354/P6354.4 6 CILINDROS.5.8LITROS VEICULAR/AGRÍCOLA

CHRYSLER TRUCK DODGE D700/750/900 1970/81

MASSEY FERGUSON TRACTOR MF 296 1976/89

PERKINS P6354.4/Q20B 6 CILINDROS.5.8LITROS TURBO VEICULAR/AGRÍCOLA

CHEVROLET TRUCK DS12000/14000 1992/96

MASSEY FERGUSON TRACTOR MF 500B 1982/87

PERKINS P6354.4 6 CILINDROS.5.8LITROS TURBO

MASSEY FERGUSON TRACTOR MF 297 1989/92 MF 299 1989/9

HS 2.8



50977147



5093644



50965504

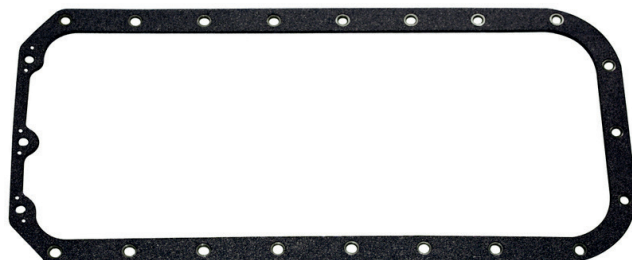

80964650



50947567



50948467



50947367



50947967



50947767



50946877



50948167

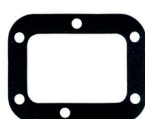

50947667



50948267



50948367

HS 2.8



50947267



50947467



50947867



509100650



50948567



RE05353S



RE05413N



RE05352S



RE02396F

80966826 KIT DE BORRACHA D229 4 CILINDROS TURBO		
Nº ABR	DESCRIÇÃO	QTD
50092529	ARRUELA DE ALUMÍNIO 12,0X18,0X1,5 MM	4
50009923	ARRUELA DE COBRE 6,4X10,0X1,0 MM	1
50011020	ARRUELA DE COBRE 7,3X15,2X1,0 MM	4
50011024	ARRUELA DE COBRE 7,3X15,2X2,0 MM	4
50070329	ARRUELA DE ALUMÍNIO 18,5X22,0X1,5 MM	7
50011228	ARRUELA DE ALUMÍNIO 8,0X12,0X1,0 MM	2
50022229	ARRUELA DE ALUMÍNIO 14,6X20,8X1,5 MM	6
50021529	ARRUELA DE ALUMÍNIO 14,0X20,0X1,5 MM	5
50026729	ARRUELA DE ALUMÍNIO 20,0X26,0X1,5 MM	8

80967226 KIT DE BORRACHA D229 4 CILINDROS TURBO		
Nº ABR	DESCRIÇÃO	QTD
50011020	ARRUELA DE COBRE 7,3X15,2X1,0 MM	4
50011024	ARRUELA DE COBRE 7,3X15,2X2,0 MM	4

Nº JOGO		DESCRIÇÃO			
60913761	JOGO DE JUNTAS COMPLETO P6354.4 ASPIRADO SEM RETENTORES		1		
70913761	JOGO DE JUNTAS COMPLETO P6354.4 ASPIRADO COM RETENTORES		2		
70933761	JOGO DE JUNTAS SUPEIOR P6354.4 ASPIRADO COM RETENTORES COM HASTE DE VÁLVULA		3		
60913763	JOGO DE JUNTAS COMPLETO P6354.4 TURBO SEM RETENTORES		4		
Nº ABR	Nº ORIGINAL	DESCRIÇÃO			
RE02590F		RET HASTE VALVULAS	12	12	
50909390	70490355	JUNTA DA TAMPA TRAS CABEÇOTE	1	1	1 1
50013349	02132	RET EIXO DA BOMBA INJETORA			1
50922198	70490352	JUNTA	1		1 1
50922298	36814124	JUNTA DA TAMPA DISTRIBUIÇÃO	1		1 1
50922898	36861745	JUNTA DA TERMOSTATO	1	1	1 1
50924190	70490363	JUNTA DA ACOMPLAMENTO BOMBA INJETORA	1		1 1
50924280	36831122	JUNTA DA BOMBA ÓLEO	1		1 1
50924412	70490414	GAXETA	1		1 1
50925570	36865532	JUNTA DA BOMBA ÓLEO	1		1 1
50925698	70490378	JUNTA DA ACIONAMENTO TAQUIMETRO	1		1 1
50931498	36867162	JUNTA DA BOMBA ÁGUA	1	1	1 1
50931757	36862507	JUNTA DA INSPEÇÃO DO TAQUIMETRO	1		1 1
50931850	36826107	JUNTA DA TAMPA INSPEÇÃO	1		1 1
50932453	70490177	JUNTA DA CARTER	1		1 1
50932490	70490371	JUNTA DA CARTER	1		1 1
50932831	36862191	JUNTA DA COL ESCAPAMENTO	2	2	2 2
50934098	70490346	JUNTA DA TUBULAÇÃO BOMBA ÓLEO	1		1 1
50934198	70490347	JUNTA DA CARÇAÇA VEDADOR TRASEIRO	1		1 1
50934616	70490373	JUNTA DA SAIDA ESCAPAMENTO	1	1	1 1
50937298	70490725	JUNTA DA BOMBA ÁGUA	1		1 1
50937798	70490725	JUNTA DA FILT AR	1	1	1 1
50938030	70490374	JUNTA DA COL ADMISSÃO	2	2	2 2
50938170	70490160	JUNTA DA SUPO EXAUSTOR	1		1 1
50940598	70490198	JUNTA DA BOCAL ÓLEO	3	3	3 3
50941055	70490265	JUNTA DA TAMPA VALVULAS	1	1	1 1
50942198	70490154	JUNTA DA BOMBA COMBUSTIVEL	1		1 1
50943398	36856102	JUNTA DA FILT ÓLEO	1		1 1
50944532	70490335	JUNTA DA COL ESCAPAMENTO	1	1	1 1
50945431	36866746	JUNTA DA COL ADMISSÃO	2	2	2 2
50945598	70490161	JUNTA DA BASE FILTRO ÓLEO	1		1 1
50945772	36866105	JUNTA DA ADAP BOMBA INJETORA	1		1 1
50945898	36822118	JUNTA DA ADAP COMPRESOR	1		1 1
50945998	36822118	JUNTA	1		1 1
50950716	36831127	JUNTA DA CARTER			
50954498	70490405	JUNTA DA TUBO SUCÇÃO BOMBA ÓLEO	1	1	1 1
50954598	36833144	JUNTA	1		2 2
50954698	36833148	JUNTA DA CARÇAÇA TERMOSTATO	1	1	1 1
50954798	70490330	JUNTA DA SUPO FILTRO	1	1	1 1
50954898	36861448	JUNTA DA SAÍDA ÁGUA	1		1 1
50958398	70490321	JUNTA DA ADAP FILT ÓLEO			
50958698	36866207	JUNTA DA BOMBA ÁGUA	1		1 1
50958698	70490410	JUNTA DA BOMBA ÁGUA			
50960096		JUNTA DA SAÍDA ÁGUA			
50971600	70490238	JUNTA DA CABEÇOTE	1	1	1 1
50976598	36814202	JUNTA DA CARÇAÇA FILTRO			
80963731	36866749	KIT TURBINA	1		
80977840		KIT ARR BRR	1	1	1 1
RE01050S		RET POLIA			1
RE01972S		RET TRASEIRO			1

• VENDE-SE AVULSO

P6354/P6354.4

APLICAÇÃO

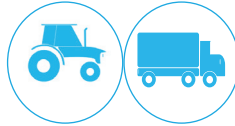

PERKINS P6354/P6354.4 6 CIL.5.8L VEICULAR/AGRÍCOLA

CHRYSLER TRUCK DODGE D700/750/900 1970/81

MASSEY FERGUSON TRACTOR MF 296 1976/89

PERKINS P6354.4/Q20B 6 CIL.5.8L TURBO VEICULAR/AGRÍCOLA

CHEVROLET TRUCK DS12000/14000 1992/96

MASSEY FERGUSON TRACTOR MF 500B 1982/87

PERKINS P6354.4 6 CIL.5.8L TURBO

MASSEY FERGUSON TRACTOR MF 297 1989/92 MF 299 1989/9

P6354/P6354.4

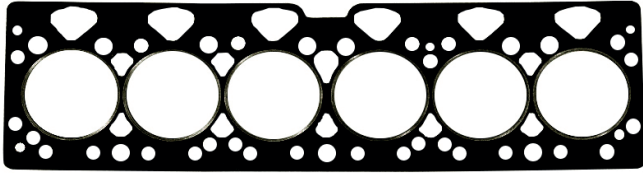

50971600

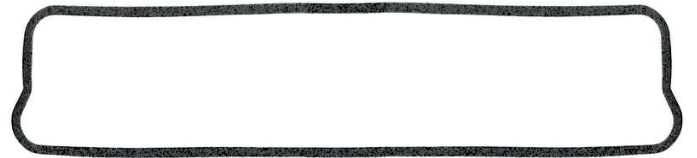

50941055

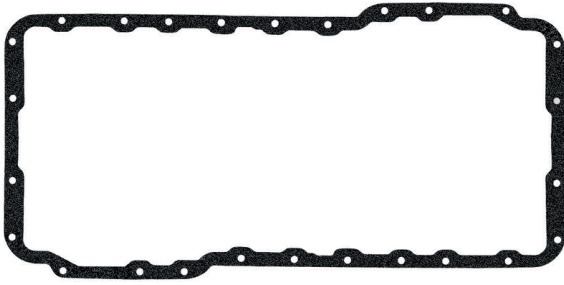

50932490

50932453

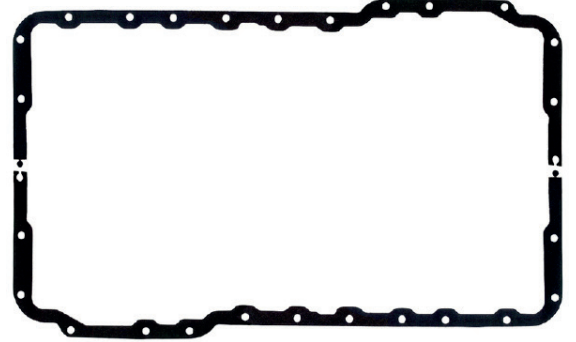

50950716

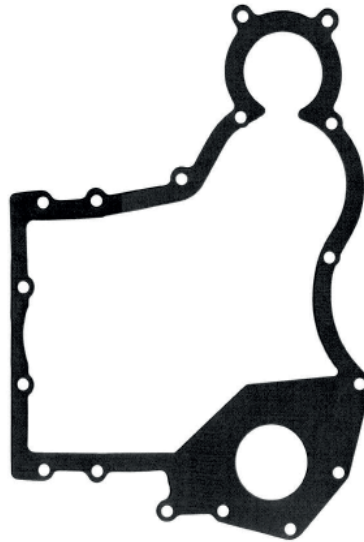

50922298

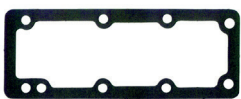

50954698

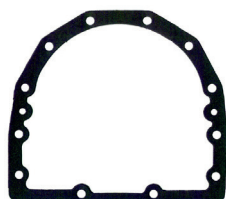

50934198

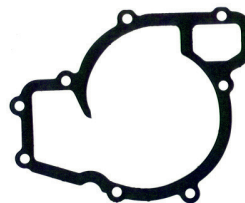

50931498

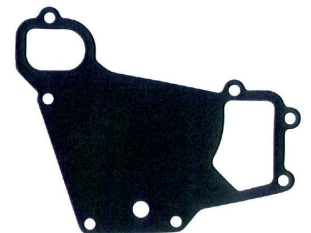

50958698

P6354/P6354.4

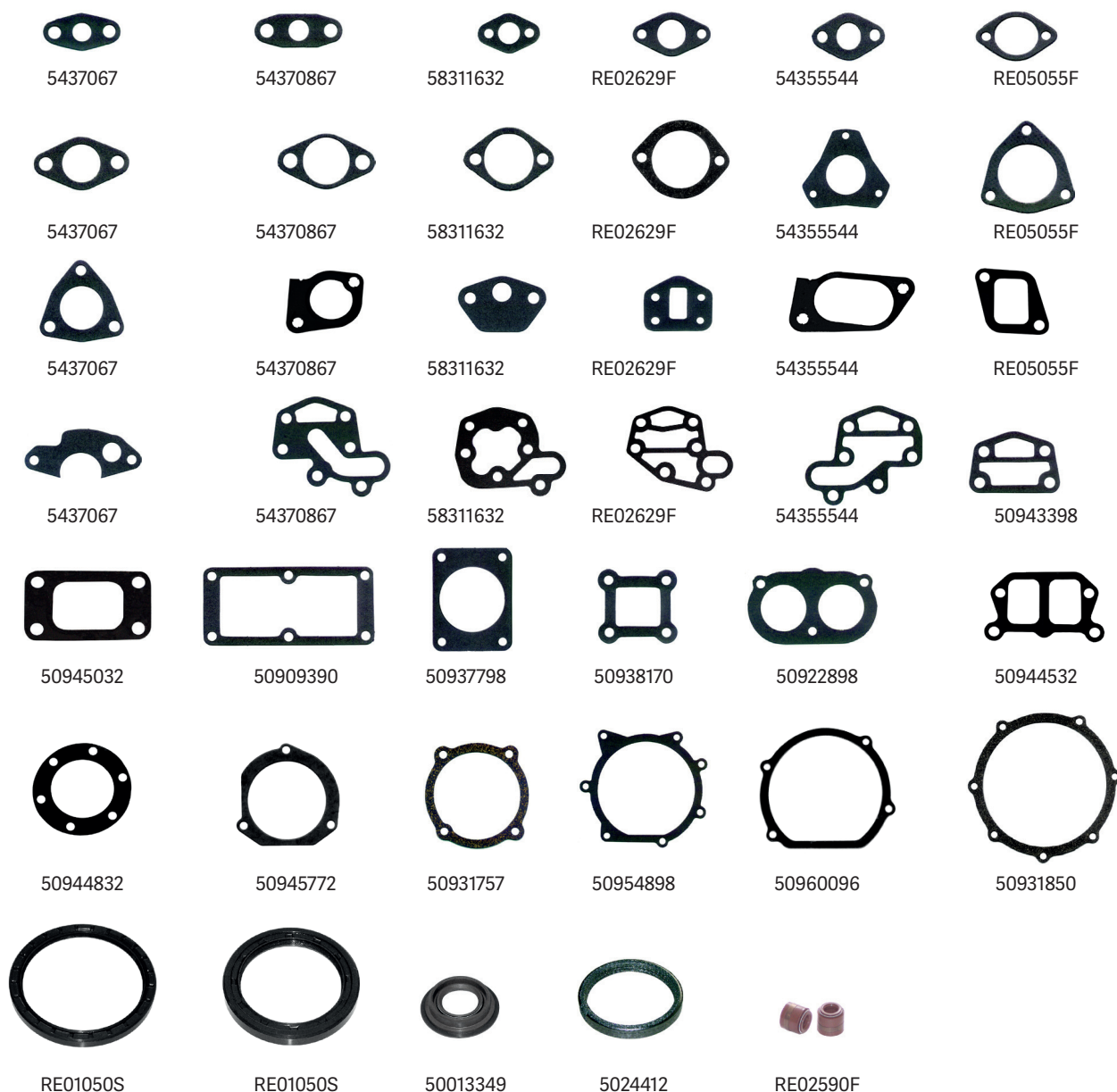

80977840		KIT DE BORRACHA D229 4 CILINDROS TURBO	
Nº ABR	Nº ORI	DESCRIÇÃO	QTD
50937620	70920081	ARRUELA DO BICO INJETOR 10,0X19,2X2,0 MM	6
50967840	70730046	VEDADOR DA PORTA INJETORA	6
50972641	32811408	VEDADOR DA PLACA INTERMEDIARIA	4
50963941	33811113	ANEL DO TUBO LUBRIFICANTE DO CABEÇOTE	1
50964041	33817132	VEDADOR DA TAMPA DE VALVULAS	4
50927541	2415813	VEDADOR 88,0X2,5 MM	1

Nº JOGO		DESCRIÇÃO			
60913761	JOGO DE JUNTAS COMPLETO P6354.4 TURBO SEM RETENTORES		1		
70913761	JOGO DE JUNTAS COMPLETO P6354.4 TURBO COM RETENTORES		2		
70933761	JOGO DE JUNTAS SUPERIOR P6354.4 TURBO COM RETENTORES		3		
60913763	JOGO DE JUNTAS COMPLETO P6354.4 TURBO SEM RETENTORES		4		
Nº ABR	Nº ORIGINAL	DESCRIÇÃO			
RE02590F		RETENTOR DA HASTE DE VÁLVULAS	12	12	12
50909390	70490355	JUNTA DA TAMPA TRASEIRA DO CABEÇOTE	1	1	1
50013349	02132	RETENTOR DO EIXO DA BOMBA INJETORA		1	1
50922198	70490352	JUNTA		1	1
50922298	36814124	JUNTA DA TAMPA DE DISTRIBUIÇÃO		1	1
50922898	36861745	JUNTA DO TERMOSTATO	1	1	1
50924190	70490363	JUNTA DO ACOMPLAMENTO DA BOMBA INJETORA		1	1
50924280	36831122	JUNTA DA BOMBA DE ÓLEO		1	1
50924412	70490414	GAXETA		1	1
50925570	36865532	JUNTA DA BOMBA DE ÓLEO		1	1
50925698	70490378	JUNTA DO ACIONAMENTO DE TAQUIMETRO		1	1
50931498	36867162	JUNTA DA BOMBA DE ÁGUA	1		1
50931757	36862507	JUNTA DA INSPEÇÃO DO TAQUIMETRO		1	1
50931850	36826107	JUNTA DA TAMPA DE INSPEÇÃO		1	1
50932453	70490177	JUNTA DO CARTER			1
50932490	70490371	JUNTA DO CARTER			1
50932831	36862191	JUNTA DO COLETOR DE ESCAPAMENTO	2	2	2
50934098	70490346	JUNTA DA TUBULAÇÃO DA BOMBA DO ÓLEO		1	1
50934198	70490347	JUNTA DA CARÇA DO VEDADOR TRASEIRO		1	1
50934616	70490373	JUNTA DA SAÍDA DO ESCAPAMENTO	1	1	1
50937298	70490725	JUNTA DA BOMBA ÁGUA		1	1
50937798	70490725	JUNTA DO FILTRO DE AR	1	1	1
50938030	70490374	JUNTA DO COLETOR DE ADMISSÃO	2	2	2
50938170	70490160	JUNTA DO SUPORTE DO EXAUSTOR		1	1
50940598	70490198	JUNTA DO BOCAL DE ÓLEO	3	3	3
50941055	70490265	JUNTA DA TAMPA DE VÁLVULAS		1	1
50942198	70490154	JUNTA DA BOMBA DO COMBUSTIVEL		1	1
50943398	36856102	JUNTA DO FILTRO DE ÓLEO		1	1
50944532	70490335	JUNTA DO COLETOR DE ESCAPAMENTO	1	1	1
50945431	36866746	JUNTA DO COLETOR DE ADMISSÃO	2	2	2
50945598	70490161	JUNTA DA BASE DO FILTRO DE ÓLEO		1	1
50945772	36866105	JUNTA DO ADAPTADOR DA BOMBA INJETORA		1	1
50945898	36822118	JUNTA DO ADAPTADOR DO COMPRESOR		1	1
50945998	36822118	JUNTA		1	1
50950716	36831127	JUNTA DO CARTER		1	1
50954498	70490405	JUNTA DO TUBO DE SUÇÃO DA BOMBA DE ÓLEO	1	1	1
50954598	36833144	JUNTA		1	1
50954698	36833148	JUNTA DA CARÇA DO TERMOSTATO	1	1	1
50954798	70490330	JUNTA DO SUPORTE DO FILTRO	1	1	1
50954898	36861448	JUNTA DA SAÍDA DE ÁGUA		1	1
50958398	70490321	JUNTA DO ADAPTADOR DO FILTRO DO ÓLEO		1	1
50958698	36866207	JUNTA DA BOMBA DE ÁGUA		1	1
50958698	70490410	JUNTA DA BOMBA DE ÁGUA		1	1
50960096		JUNTA DA SAÍDA DE ÁGUA		1	1
50971600	70490238	JUNTA DO CABEÇOTE	1	1	1
50976598	36814202	JUNTA DA CARÇA DO FILTRO		1	1
80963731	36866749	KIT DA TURBINA	1	1	1
80977840		KIT DE BORRACHA E ARRUELA		1	1
RE01050S		RETENTOR DA POLIA		1	1
RE01972S		RETENTOR TRASEIRO	1		1

• VENDE-SE AVULSO

P6354/P6354.4

APLICAÇÃO



PERKINS P4203 INJEÇÃO INDIRETA 4 CILINDROS 3.3LINDROS

FORD TRACTOR 8BR 1961/67

PERKINS P4203 INJEÇÃO INDIRETA 4 CILINDROS 3.3LITROS

MASSEY FERGUSON TRACTOR MF 65 1965/82 CBT TRACTOR 1000 1975/...CASE TRACTOR 580E 1972/85

P6354/P6354.

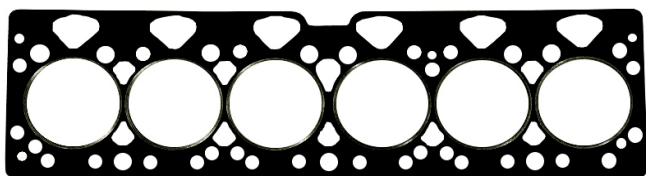

50971600

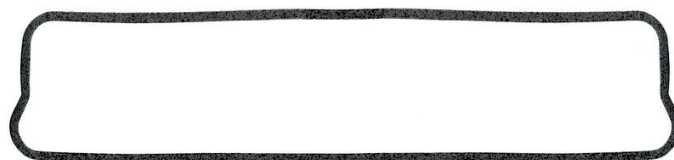

50941055

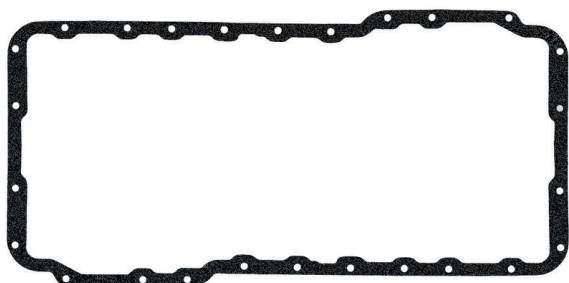

50932490

50932453

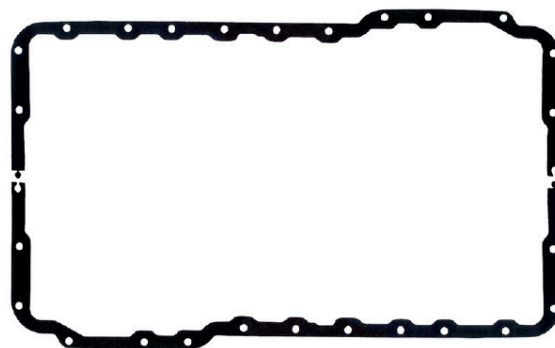

50950716

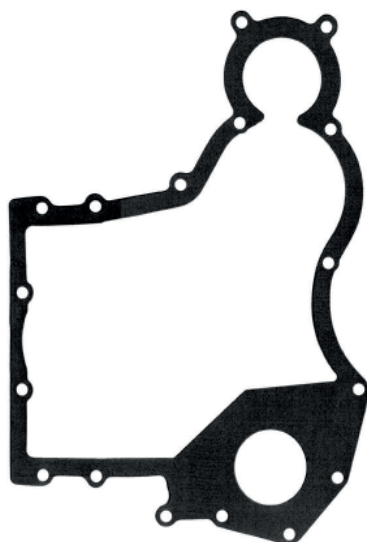

50922298

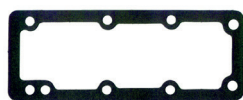

50954698

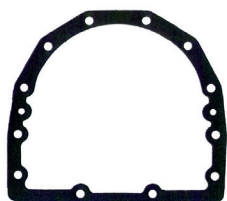

50934198

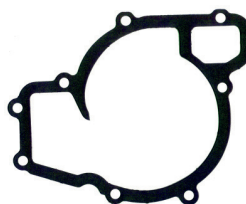

50931498

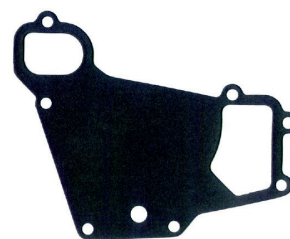

50958698

P6354/P6354.4

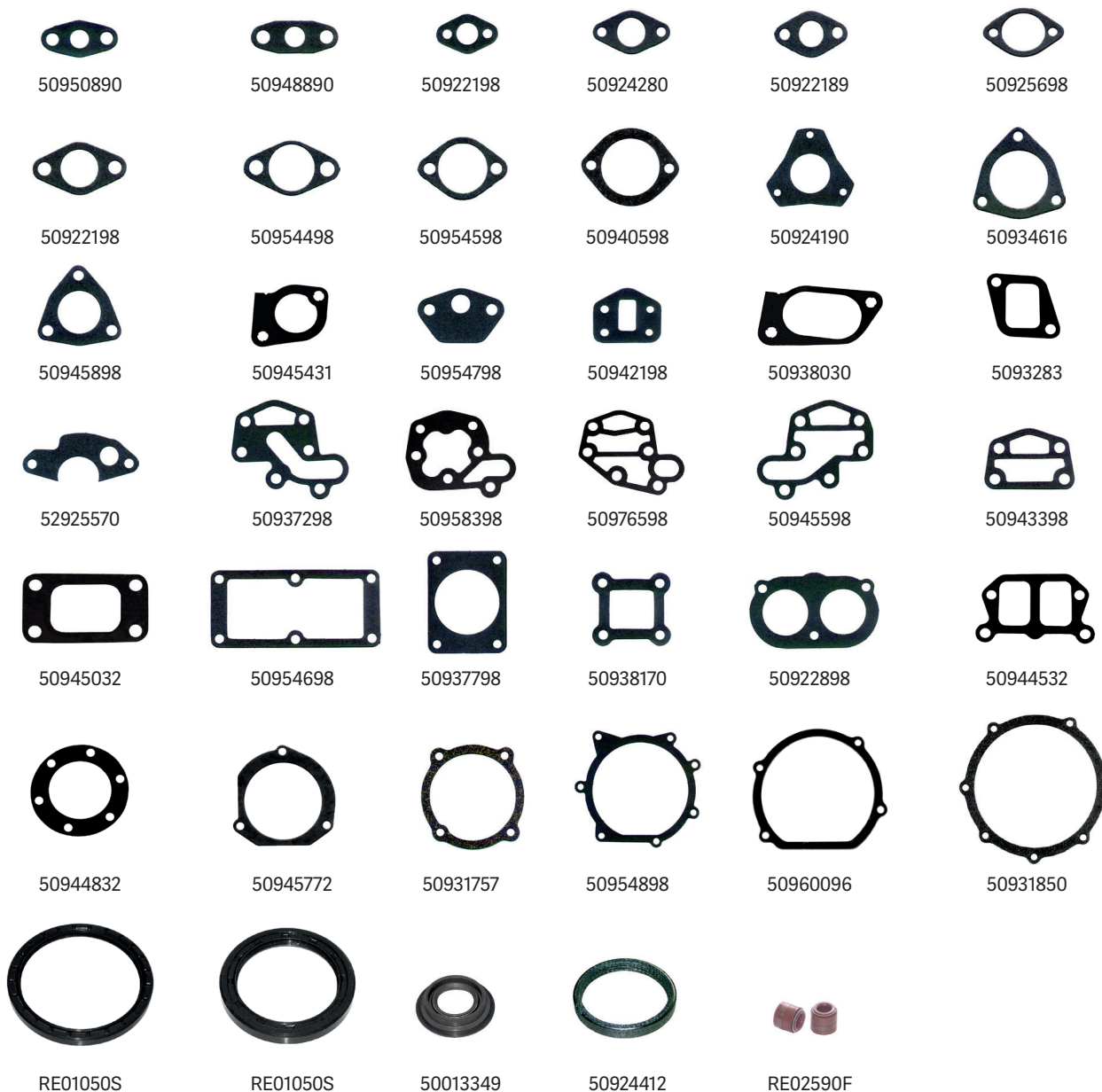

80977840		KIT DE BORRACHA D229 4 CILINDROS TURBO	
Nº ABR	Nº ORIG	DESCRIÇÃO	QTD
50937620	70920081	ARRUELA DO BICO INJETOR 10,0X19,2X2,0 MM	6
50967840	70730046	VEDADOR DA PORTA INJETORA	6
50972641	32811408	VEDADOR DA PLACA INTERMEDIARIA	4
50963941	33811113	ANEL DO TUBO LUBRIFICANTE DO CABEÇOTE	1
50964041	33817132	VEDADOR DA TAMPA DE VALVULAS	4
50927541	2415813	VEDADOR 88,0X2,5 MM	1

Nº JOGO		DESCRIÇÃO		
60912881	JOGO DE JUNTAS COMPLETO P6357 SEM RETENTORES		1	
70912881	JOGO DE JUNTAS COMPLETO P6357 COM RETENTORES		2	
70932881	JOGO DE JUNTAS SUPERIOR P6357 COM RETENTORES		3	
Nº ABR	Nº ORIGINAL	DESCRIÇÃO		
RE00586S		RETENTOR DA POLIA		1
50906217	70490020	JUNTA DO TUBO DO ESCAPAMENTO	1	1 1
50050567		GAXETA DE BANCADA		2 2
50906190	70490340	JUNTA DA TAMPA DO PACIONADOR DO TAQUIMETRO		1 1
50907390	70490349	JUNTA DA TAMPA DO RETENTOR		1 1
50907498	70490350	JUNTA DO TUBO DA SAÍDA DA BOMBA DE ÓLEO		1 1
50907850	70490201	JUNTA DA TAMPA DA CAMARA DE ÁGUA		2 2
50907998	70490288	JUNTA DO BOCAL DO BLOCO		1 1
50908390	70490351	JUNTA DA TAMPA TRASEIRA	1	1 1
50908498	70490723	JUNTA DO GARGALO DE ADMISSÃO	1	1 1
50908716	70490123	JUNTA DO COLETOR DE ADMISSÃO	1	1 1
50909616	70490358	JUNTA DO COLETOR DE ESCAPAMENTO	3	3 3
50909798	70490745	JUNTA DO TERMOSTATO DO CABEÇOTE	1	1 1
50909855	70490139	JUNTA DA TAMPA DE VÁLVULAS	1	1 1
509105067	70409393	JUNTA DO CARTER		1 1
50910998	70490336	JUNTA DO SUPORTE DA BOMBA DE ÁGUA		1 1
50914198	70490381	JUNTA DO SUPORTE DA BOMBA DE ALIMENTAÇÃO		1 1
50915401	70490743	JUNTA DO CABEÇOTE	1	1 1
50915698	70490049	JUNTA DO TUBO DA VAZÃO DA BOMBA DE ÓLEO		2 2
50915798	70490392	JUNTA DA CARÇA DA BOMBA DE ÁGUA		1 1
50915953	70490132	JUNTA DO CARTER		1 1
50916098	70490063	JUNTA DO ACOMPLAMENTO DA BOMBA DE ÁGUA		1 1
50916152	70490065	JUNTA DA TAMPA DE INSPEÇÃO DA DISTRIBUIÇÃO		2 2
50916298	70490071	JUNTA DA CONEXÃO DA SAÍDA DE ÁGUA	1	1 1
50916398	70490073	JUNTA DA CONEXÃO SUPERIOR DA SAÍDA ÁGUA	1	1 1
50916796	70490395	JUNTA DO COLETOR DE ADMISSÃO	1	1 1
50916898	70490092	JUNTA DA TAMPA DE DISTRIBUIÇÃO		1 1
50918998	70490136	JUNTA DA PLACA DA BOMBA ALIMENTADORA		1 1
50919098	70490397	JUNTA DA BOMBA DO COMBUSTIVEL		1 1
50924412	70490414	JUNTA DA SAÍDA DO ESCAPAMENTO	1	1
50927098	70490304	JUNTA DA INSPEÇÃO DA DISTRIBUIÇÃO		1 1
50930998	70490091	JUNTA DA SUCÇÃO DA BOMBA DE ÓLEO		1 1
50931698	70490143	JUNTA DO SUPORTE DO FILTRO DE ÓLEO		2 2

• VENDE-SE AVULSO

P6357

APLICAÇÃO



PERKINS P6357/P6357.2 6 CILINDROS 5.8LITROS VEICULAR/AGRÍCOLA

FORD TRUCK F11000/F12000/F13000 1981/81

M.FERGUSON TRACTOR MF 3366 1971/74 ; MF 400 1976/84 ; MF 500B 1974/82 ; MF 95X 1973/85

CHRYSLER TRUCK DODGE D700/750/900 1975/81

CHEVROLET TRUCK D60 1965/85 ; D79/75 1970/85

DS14 - LK140 / LK141 8 CILINDROS 1974

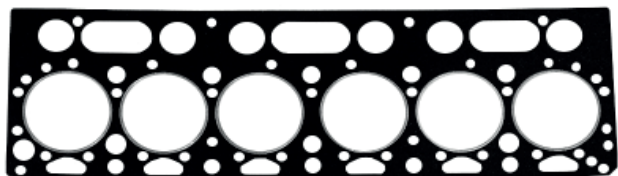

50915401

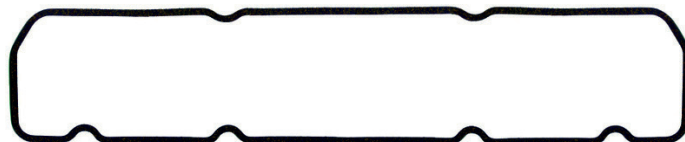

50909855



509105067



50915953

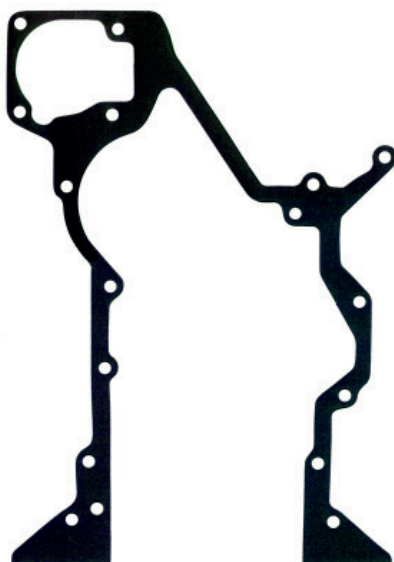

50916898

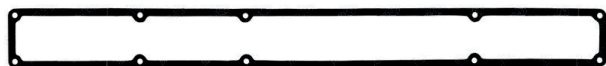

50916796



50907850

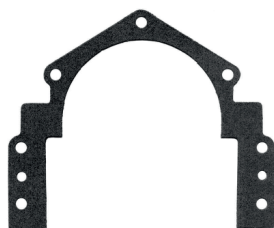

50907390



50916152

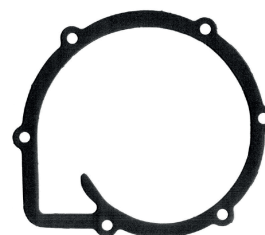

50915798

DS14 - LK140 / LK141 8 CILINDROS 1974



50907998



50915698



50908498



50907498



50908498



50906217



50916298



50916398



50931698



5090616



50914198



50919095



50916098



50906190



50908716

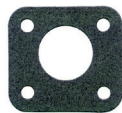

50910998



50918998



RE05055F

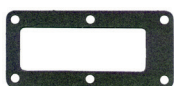

50908390



50927098



RE00586S



50924412



50050567

80956190 KIT DE BORRACHA D229 4 CILINDROS TURBO			
Nº ABR	DESCRIÇÃO		QTD
50022224	ARRUELA	14,0X20,8X1,5 MM	6
50035623	ARRUELA DE COBRE	40,3X46,7X1,0 MM	6
50945641	VEDADOR DA HASTE DE VÁLVULA		12

Nº JOGO		DESCRIÇÃO				
60913439		JOGO DE JUNTAS COMPLETO P6358 SEM RETENTORES				1
70913439		JOGO DE JUNTAS COMPLETO P6358 COM RETENTORES				2
70933431		JOGO DE JUNTAS SUPERIOR P6358 SEM RETENTORES				3
60933431		JOGO DE JUNTAS SUPERIOR P6358 SEM RETENTORES				4
Nº ABR	Nº ORIGINAL	DESCRIÇÃO				
RE02590F		RETENTOR DA HASTE DE VÁLVULAS	12	12		
50905650	70490096	JUNTA DA TAMPA DE VÁLVULAS	1	1	1	1
50906190	70490340	JUNTA DA TAMPA DO ACIONADOR DO TAQUIMETRO			1	1
50906217	70490020	JUNTA DA SAÍDA DO ESCAPAMENTO			1	1
50906716	70490106	JUNTA DO COLETOR DO ESCAPAMENTO	1	1	1	1
50907498	70490350	JUNTA DO TUBO DA SAÍDA DA BOMBA DE ÓLEO			1	1
50907850	70490101	JUNTA DA TAMPA DA CAMARA DA ÁGUA			2	2
50907998	70490288	JUNTA DO BOCAL DO BLOCO			1	1
50908498	70490421	JUNTA DO GARGALO DA ADMISSÃO	1	1	1	1
50908716	70490400	JUNTA DO COLETOR DA SAÍDA DO ESCAPAMENTO	1	1	1	1
509104967	70490393	JUNTA DO CARTER			1	1
50910998	70490734	JUNTA DO SUPORTE DA BOMBA DE ÁGUA			1	1
50914198	70490381	JUNTA DO SUPORTE DA BOMBA ALIMENTORA			1	1
50915698	70490049	JUNTA DO TUBO DA VAZÃO DA BOMBA DE ÓLEO			1	1
50915798	70490392	JUNTA DA CARÇAÇA DE ÁGUA			1	1
50915953	70490132	JUNTA DO CARTER			1	1
50916098	70490063	JUNTA DO ACOMPLAMENTO DA BOMBA			1	1
50916152	70490065	JUNTA DA TAMPA DA INSPEÇÃO DA DISTRIBUIÇÃO			2	2
50917098	704490097	JUNTA DA TAMPA DE DISTRIBUIÇÃO			1	1
50917116	70490107	JUNTA DA LATERAL DO COLETOR DE ESCAPAMENTO	2	2	2	2
50917398	70490114	JUNTA DA TAMPA TRASEIRA		1	1	1
50917598	70490128	JUNTA DA PLACA DE DISTRIBUIÇÃO			1	1
50918995	70490112	JUNTA DA *AMP BOMBA ALIMENTADORA			1	1
50919098	70490397	JUNTA DA BOMBA DE COMBUSTIVEL			1	1
50924412	70490414	JUNTA DA SAÍDA DO ESCAPAMENTO		1	1	1
50926950	70490026	JUNTA DA TAMPA DO TAQUIMETRO			1	1
50927098	70490394	JUNTA DA INSPEÇÃO DE DISTRIBUIÇÃO			1	1
50927198	70490069	JUNTA DO TUBO DE ESCAPAMENTO			1	1
50930409	70490196	JUNTA DO CABEÇOTE		1	1	1
50930590	70490809	JUNTA DA TAMPA DA CAMARA DE ÁGUA		2	2	2
50930690	70490117	JUNTA DO COLETOR DE ADMISSÃO		2	2	2
50930790	70490201	JUNTA DO COLETOR CENTRAL DE ADMISSÃO		2	2	2
50930890	70490119	JUNTA DA CONEXÃO SUPERIOR DO TERMOSTATO		1	1	1
50930998	70490091	JUNTA DA SUCÇÃO DA BOMBA DE ÓLEO			1	1
50931698	70490143	JUNTA DO SUPORTE DO FILTRO DE ÓLEO			1	1
50934598	70490116	JUNTA DA TAMPA TRASEIA DO CABEÇOTE		1	1	1
50959967	70490153	JUNTA DO COLETOR DE ESCAPAMENTO		4	4	4
80978126		KIT DE ARRUELAS E BORRACHAS		1	1	1
RE01050S		RETENTOR POLIA				1
RE01972S		RETENTOR TRASEIRO				

• VENDE-SE AVULSO

P6358

APLICAÇÃO



PERKINS P6358 6 CIL.5.8L VEICULAR/AGRÍCOLA

FORD TRUCK F11000/F12000/F13000 1982/92

M.FERGUSON TRACTOR MF 295 1976/89 MF 400C 1971/74

CHEVROLET TRUCK D11000/D13000/19000/21000/22000 1985/91 D12000 1991/96

P6358

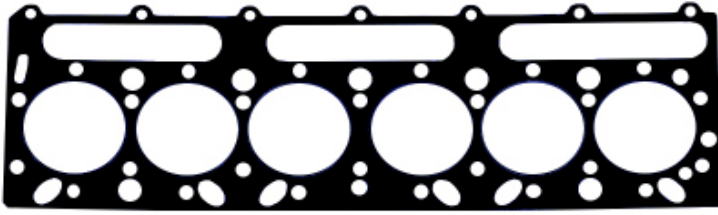

50930409



50905650

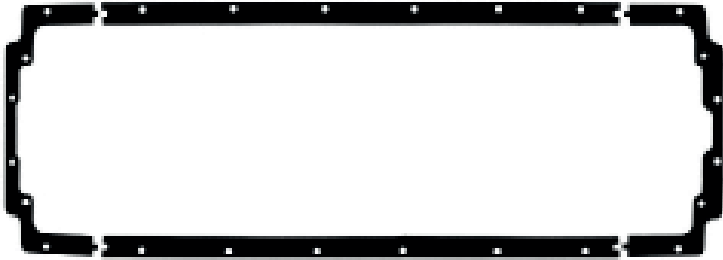

509104967



50915953

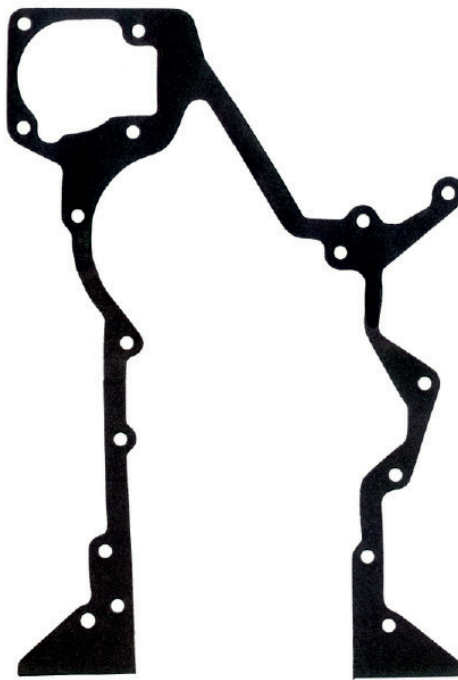

50917098

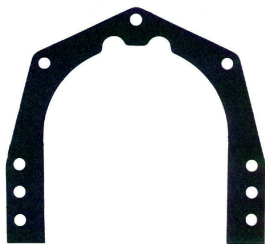

50917598



50916152

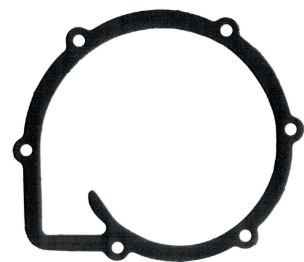

50915798

P6358



50906716

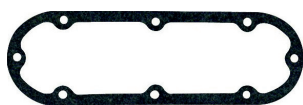

50907850

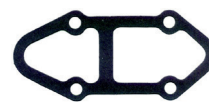

50927198



50907998



50907498



50915698



50930998



50908498



50906217



50916098



50930590



50930690



50931698



50914198



50919095



50906190

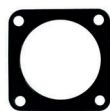

50908716



50926950



50910998



50918995



RE05055F



50930890



509030790



50917116



50934598



50917390



50927098



RE01972S



RE01050S



50924412



50959967



RE02590F

80978126 KIT DE BORRACHA D229 4 CILINDROS TURBO		
Nº ABR	DESCRIÇÃO	QTD
50011228	ARRUELA DE ALUMÍNIO 8,0X12,8X1,0 MM	13
50019725	ARRUELA DE ALUMÍNIO 13,2X17,1X2,0 MM	12
50014029	ARRUELA DE ALUMÍNIO 10,0X14,1X1,5 MM	12
50014024	ARRUELA DE COBRE 9,6X18,0X1,5 MM	6
50937620	ARRUELA DE COBRE 10,0X19,2X2,0 MM	6

The IVECO logo is centered on the page. It consists of a stylized graphic of three parallel diagonal lines on the left, followed by the word "IVECO" in a bold, uppercase, sans-serif font. The entire logo is rendered in a solid blue color. The logo is positioned in the center of the page, which is framed by a blue border that has a gap at the top and bottom.

IVECO

Nº ABR	MOTOR	DESCRIÇÃO		PÁGINA
63510101	DUCATO 2.5/2.8	JOGO DE JUNTAS COMPLETO	SEM RETENTORES	180
73510121	DUCATO 2.5/2.8	JOGO DE JUNTAS COMPLETO	COM RETENTORES	180
63510121	DUCATO 2.5/2.8	JOGO DE JUNTAS SUPERIOR	SEM RETENTORES	180
73510121	DUCATO 2.5/2.8	JOGO DE JUNTAS SUPERIOR	COM RETENTORES	180
73530101	DUCATO 2.5/2.8	JOGO DE JUNTAS INFERIOR	SEM RETENTORES	180
73510131	DUCATO 2.8	JOGO DE JUNTAS INFERIOR	COM INJEÇÃO INDIRETA E COM RETENTORES	184
63540131	DUCATO 2.8	JOGO DE JUNTAS COMPLETO	COM INJEÇÃO INDIRETA E SEM RETENTORES	184
73540131	DUCATO 2.8	JOGO DE JUNTAS SUPERIOR	COM INJEÇÃO INDIRETA E SEM RETENTORES	184
73530101	DUCATO 2.5/2.8	JOGO DE JUNTAS INFERIOR	COM INJEÇÃO INDIRETA E SEM RETENTORES	184
73510162	JTD 2.3	JOGO DE JUNTAS COMPLETO	SEM RETENTORES	188
73530162	JTD 2.3	JOGO DE JUNTAS COMPLETO	COM RETENTORES	188
73510182	F1CE0481D	JOGO DE JUNTAS SUPERIOR	SEM RETENTORES	190
73530182	F1CE0481D	JOGO DE JUNTAS SUPERIOR	COM RETENTORES	190
73510202	CURSOR 8	JOGO DE JUNTAS INFERIOR	SEM RETENTORES	192
73530202	CURSOR 8	JOGO DE JUNTAS INFERIOR	COM RETENTORES	192
73510252	CURSOR 9	JOGO DE JUNTAS COMPLETO	SEM RETENTORES	194
73530252	CURSOR 9	JOGO DE JUNTAS COMPLETO	COM RETENTORES	194
73510352	CURSOR 10	JOGO DE JUNTAS SUPERIOR	SEM RETENTORES	196
73530352	CURSOR 10	JOGO DE JUNTAS SUPERIOR	COM RETENTORES	196
73510302	CURSOR 13	JOGO DE JUNTAS INFERIOR	SEM RETENTORES	198
73530302	CURSOR 13	JOGO DE JUNTAS INFERIOR	COM RETENTORES	198

Nº JOGO	DESCRIÇÃO				
63510101	JOGO DE JUNTAS COMPLETO IVECO 2.5/2.8 INJEÇÃO DIRETA SEM RETENTORES				1
73510101	JOGO DE JUNTAS COMPLETO IVECO 2.5/2.8 INJEÇÃO DIRETA COM RETENTORES				2
63510121	JOGO DE JUNTAS COMPLETO IVECO 2.5 INJEÇÃO INDIRETA(DAILY 30.8/35.8/40.8/FIAT DUCATO/RENAULT MASTER)SEM RETENTORES				3
73510121	JOGO DE JUNTAS COMPLETO IVECO 2.5 INJEÇÃO INDIRETA(DAILY 30.8/35.8/40.8/FIAT DUCATO/RENAULT MASTER)COM RETENTORES				4
73530101	JOGO DE JUNTAS SUPERIOR IVECO 2.5/2.8 INJEÇÃO DIRETA(FIAT DUCATO/RENAULT MASTER)COM RETENTORES				5

Nº ABR	Nº ORIGINAL	DESCRIÇÃO					
50945032	36885008	JUNTA DA BASE DA TURBINA	1	1	1		
50951832	3688A004	JUNTA DO CARACOL DA TURBINA	1	1	1		
53500300	99432354	JUNTA DO CABEÇOTE					1
53500530	99436990	JUNTA DO COTOVELO DA TURBINA					1
53501940	500388382	JUNTA DA TAMPA DE VÁLVULAS	1				1
53502018	98434020	JUNTA DO COLETOR DE ESCAPE	4	4	4	4	
53502330	93255173	JUNTA DO COTOVELO DA TURBINA					1
53502418	98484659	JUNTA DO COLETOR DA TURBINA					1
53502547	98425767	JUNTA DO COLETOR DE ADMISSÃO	4	4	4	4	
53502750		JUNTA DO BOCAL DE ÓLEO	1	1	1	1	
53502967	500310543	JUNTA DA BOMBA DO VACUO	1	1	1		
53503067	53503067	JUNTA DO FILTRO DE ÓLEO	1	1	1		
53503167		JUNTA DA TAMPA TRASEIRA	1	1	1		
53503267		JUNTA DO REGULADOR DE TEMPERATURA	1	1	1		
53503367		JUNTA DA ENTRADA DE ÓLEO DA TURBINA	1	1	1		
53503467		JUNTA DA BOMBA DO COMBUSTIVEL	1	1	1		
53503567		JUNTA DO CANO DE ÁGUA	4	4	4		
53503667		JUNTA DA SAÍDA ÓLEO TURBINA	1	1	1		
53503767		JUNTA DO CANO DE ÁGUA	1	1	1	1	1
53503867	98421275	JUNTA DA TAMPA DIANTEIRA	1	1	1	1	1
53503967	500329904	JUNTA DO TERMOSTATO	1	1	1	1	1
53504067	500349423	JUNTA DA BASE DO FILTRO	1	1	1	1	1
53504167	500329970	JUNTA DA TAMPA DE INSPEÇÃO	1	1	1	1	1
53504367	98421263	JUNTA DE DISTRIBUIÇÃO	1	1	1	1	1
53504467		JUNTA TRASEIRA	1	1	1	1	1
53504567	4851923	JUNTA DA BOMBA INJETORA	1	1	1	1	1
53504667		JUNTA DA TAMPA TRASEIRA	1	1	1	1	1
53504767	98444187	JUNTA DO TURBO DO COLETOR DE ADMISSÃO	1	1	1	1	1
53504940	99432807	JUNTA DO INT DO BLOCO ESQUERDO	1	1	1	1	1
53505040	99432808	JUNTA DO INT DO BLOCO DIRETO	1	1	1	1	1
53505367		JUNTA DE DISTRIBUIÇÃO	1	1	1	1	1
53505467	99436992	JUNTA DO TUBO LUBRIFICANTE	1	1	1		
53505500	98492580	JUNTA DO CABEÇOTE	1	1	1		
53505640	500316259	JUNTA DA TAMPA DE VÁLVULAS	1	1	1		
54424136	4834948	JUNTA DA BASE DA TURBINA		1	1		
83500120		KIT DE ARRUELAS					1
83500241		KIT DE BORRACHAS	1	1	1		
83500320		KIT DE ARRUELAS	1	1	1		
83500441		KIT DE BORRACHAS					1
53502650		JUNTA DO CARTER +					1
53502850		JUNTA DO CARTER +	1	1	1	1	1
RE05537F	99433995	RETENTOR DO COMANDO DE VÁLVULAS	1	1	1	1	1
RE09038F	99457401	RETENTOR DIANTEIRO +		1			1
RE09039F	99483227	RETENTOR TRASEIRO DO VIRABREQUIM +		1			1
RE09284F	9060530358	RETENTOR DA HASTE DE VÁLVULAS		1			1

● VENDE-SE AVULSO

IVECO DUCATO 2.5 / 2.8 TURBO DIESEL

APLICAÇÃO



IVECO TURBODAILY 1996/...
FIAT DUCATO 14 1998/01 MAXI 18 1996/02
CITROEN JUMPER II HDI 2004/...JUMPER HDI 2000/06
PEUGEOT BOXER HDI/TDI 2000/01 BOXER 4X4 HDI 2002/...
RENAULT MASTER II 1998/03
IVECO TURBODAILY 1987/89
FIAT DUCATO TD 1985/88
RENAULT TRAFIC 1997/...
IVECO DAILY 30.8/35.8 1996/...
FIAT DUCATO 14/MAXI 18 1998/01
CITROEN JUMPER 2001/02
PEUGEOT BOXER 2000/02

IVECO DUCATO 2.5 / 2.8 TURBO DIESEL

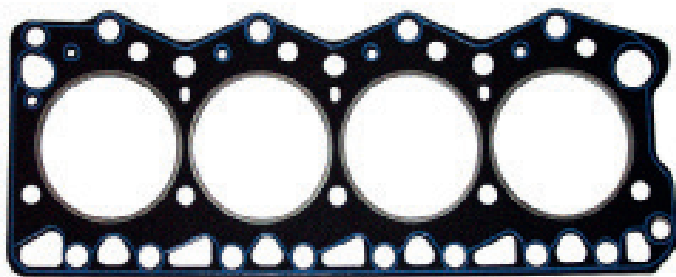

53500300

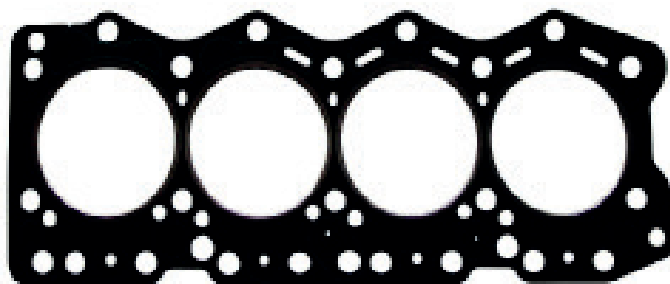

53505500



53501940



53505640

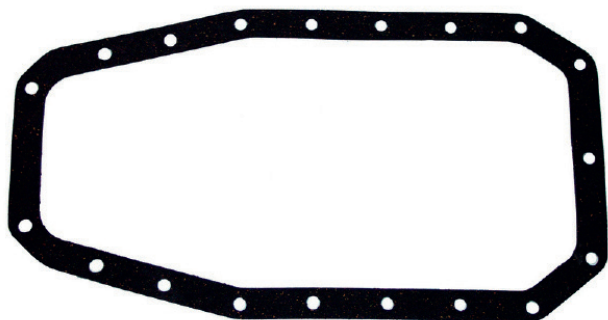

53502650

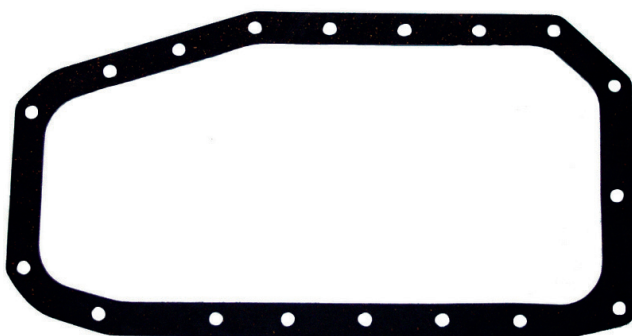

53502850



53505040



53505367

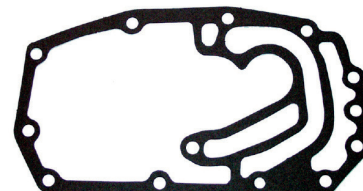

53504367



53502330



53502418

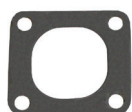

53500530



53503567



53503767



53502547



54424136



50945032



50951832



53504767



53504567



53502018



53503967

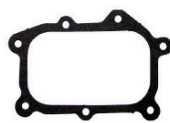

53503167



53504067



53503267



53504167



53503067

IVECO DUCATO 2.5 / 2.8 TURBO DIESEL



83500441		KIT DE BORRACHA	
Nº ABR	DESCRIÇÃO	QTD	
17281881	VEDADOR 17,2X2,6 MM	2	
17264381	VEDADOR 47,2X3,5 MM	3	
17229881	VEDADOR 9,2X1,8 MM	3	
17288481	VEDADOR 17,2X1,8 MM	4	
17281981	VEDADOR 18,7X2,6 MM	2	
14462881	VEDADOR 18,0X3,5 MM	1	
17282780	VEDADOR 22,0X1,8 MM	2	
17282281	VEDADOR 23,4X2,7 MM	1	
17282681	VEDADOR 29,7X2,7 MM	1	
17282681	VEDADOR 37,8X2,7 MM	1	
17289681	VEDADOR 44,0X3,5 MM	1	
17283881	VEDADOR 49,0X2,7 MM	1	
17280280	VEDADOR 56,9X1,8 MM	1	
17274281	VEDADOR 55,0X2,6 MM	1	
17290180	VEDADOR 59,92X3,6MM	1	
17284880	VEDADOR 64,7X2,7 MM	1	
17291381	VEDADOR 94,8X3,5 MM	1	
17291381	VEDADOR 98,0X3,5 MM	1	
14464880	VEDADOR 62,9X3,5 MM	1	
14471780	VEDADOR 66,0X5,4 MM	1	

83500241		KIT DE BORRACHA	
Nº ABR	DESCRIÇÃO	QTD	
17281881	VEDADOR 17,2X2,6 MM	1	
17281383	VEDADOR 9,2X2,6 MM	3	
17282082	VEDADOR 19,7X2,0 MM	2	
17288581	VEDADOR 18,5X1,8 MM	2	
17286882	VEDADOR 20,6X1,8 MM	2	
17282281	VEDADOR 23,4X2,7 MM	1	
17282083	VEDADOR 20,0X2,7 MM	16	
17282681	VEDADOR 29,7X2,7 MM	2	
17283881	VEDADOR 49,0X2,7 MM	1	
17280281	VEDADOR 56,9X1,8 MM	2	
17282181	VEDADOR 21,9X2,6 MM	1	
17284880	VEDADOR 64,7X2,7 MM	1	
17291381	VEDADOR 98,0X3,5 MM	1	

83500320		KIT DE BORRACHA	
Nº ABR	DESCRIÇÃO	QTD	
50015423	ARRUELA DE COBRE 10,0X13,8X1,0 MM	4	
50013022	ARRUELA DE COBRE 8,0X13,8X0,80 MM	4	
	ARRUELA DE ALUMINIO 7,0X12,6X1,6 MM	4	
50018724	ARRUELA DE COBRE 12,0X18,0X1,6 MM	4	
50021224	ARRUELA DE COBRE 14,0X20,0X1,5 MM	4	
50070324	ARRUELA DE COBRE 18,0X22,0X1,5 MM	1	
50026723	ARRUELA DE COBRE 20,0X26,0X1,0 MM	1	
	ARRUELA DE COBRE 20,0X26,0X0,70MM	1	
50072424	ARRUELA DE COBRE 22,0X27,0X1,5 MM	1	

83500120		KIT DE BORRACHA	
Nº ABR	DESCRIÇÃO	QTD	
50018723	ARRUELA DE COBRE 12,0X18,0X1,0 MM	4	
	ARRUELA DE COBRE 9,1X13,8X0,5 MM	5	
50026724	ARRUELA DE COBRE 20,0X26,0X1,5 MM	3	
50021124	ARRUELA DE ALUMINIO 14,0X18,0X1,5 MM	4	
50028724	ARRUELA DE COBRE 22,3X27,9X1,5 MM	4	
50030724	ARRUELA DE COBRE 28,3X37,4X1,5 MM	1	
50015423	ARRUELA DE COBRE 10,0X13,8X1,0 MM	2	
50015428	ARRUELA DE ALUMINIO 10,0X13,8X1,0 MM	1	

Nº JOGO		DESCRIÇÃO			
73510131	JOGO DE JUNTAS COMPLETO IVECO 2.8 INJEÇÃO INDIRETA (DAILY 30.8/35.8/ FIAT DUCATO 14/18) COM RETENTORES		1		
63540131	JOGO DE JUNTAS SUPERIOR IVECO 2.8 INJEÇÃO INDIRETA (DAILY 30.8/35.8/ FIAT DUCATO 14/18) SEM RETENTORES		2		
73540131	JOGO DE JUNTAS SUPERIOR IVECO 2.8 INJEÇÃO INDIRETA (DAILY 30.8/35.8/ FIAT DUCATO 14/18) COM RETENTORES		3		
73530101	JOGO DE JUNTAS SUPERIOR IVECO 2.5/2.8 INJEÇÃO DIRETA (FIAT DUCATO/RENAULT MASTER) COM RETENTORES		4		
Nº ABR	Nº ORIGINAL	DESCRIÇÃO			
50945032	36885008	JUNTA DA BASE DA TURBINA	1	1	1
50951832	3688A004	JUNTA DO CARACOL DA TURBINA	1	1	1
53500300	99432354	JUNTA DO CABEÇOTE	1		
53500530	99436990	JUNTA DO COTOVELO DA TURBINA	1		
53501940	500388382	JUNTA DA TAMPA DE VÁLVULA	1	1	1
53502018	98434020	JUNTA DO COLETOR DE ESCAPE	4	4	4
53502330	93255173	JUNTA DO COTOVELO DA TURBINA	1		
53502418	98484659	JUNTA DO COLETOR DA TURBINA	1		
53502547	98425767	JUNTA DO COLETOR DE ADMISSÃO	4		
53502750		JUNTA DO BOCAL DE ÓLEO	1	1	1
53502967	500310543	JUNTA DA BOMBA DO VACUO	1	1	1
53503067	53503067	JUNTA DO FILTRO DE ÓLEO	1	1	1
53503167		JUNTA DA TAMPA TRASEIRA	1	1	1
53503267		JUNTA DO REGULADOR DE TEMPERATURA	1	1	1
53503367		JUNTA DA ENTRADA DE ÓLEO DA TURBINA	1	1	1
53503467		JUNTA DA BOMBA DO COMBUSTIVEL	1	1	1
53503567		JUNTA DO CANO DE ÁGUA	1	1	1
53503667		JUNTA DA SAÍDA ÓLEO TURBINA	4	4	4
53503767		JUNTA DO CANO DE ÁGUA			1
53503867	98421275	JUNTA DA TAMPA DIANTEIRA	1		1
53503967	500329904	JUNTA DO TERMOSTATO	1		1
53504067	500349423	JUNTA DA BASE DO FILTRO	1		1
53504167	500329970	JUNTA DA TAMPA DE INSPEÇÃO	1		1
53504367	98421263	JUNTA DE DISTRIBUIÇÃO	1		1
53504467		JUNTA TRASEIRA			1
53504567	4851923	JUNTA DA BOMBA INJETORA	1		1
53504667		JUNTA DA TAMPA TRASEIRA	1	1	1
53504767	98444187	JUNTA DO TURBO DO COLETOR DE ADMISSÃO	1	1	1
53504940	99432807	JUNTA DO INT DO BLOCO ESQUERDO	1	1	1
53505040	99432808	JUNTA DO INT DO BLOCO DIREITO	1	1	1
53505367		JUNTA DE DISTRIBUIÇÃO	1	1	1
53505467	99436992	JUNTA DO TUBO LUBRIFICANTE	1	1	1
53505500	98492580	JUNTA DO CABEÇOTE	1	1	1
53505640	500316259	JUNTA DA TAMPA DE VÁLVULA			1
54424136	4834948	JUNTA DA BASE DA TURBINA			1
83500120		KIT DE ARRUELA			
83500241		KIT DE BORRACHA	1		
83500320		KIT DE ARRUELA	1	1	1
83500441		KIT DE BORRACHA	1	1	1
53502650		JUNTA DO CARTER +			
53502850		JUNTA DO CARTER +	1		
RE05537F	99433995	RETENTOR DO COMANDO DE VÁLVULAS	1		
RE09038F	99457401	RETENTOR DIANTEIRO +			
RE09039F	99483227	RETENTOR TRASEIRO DO VIRABREQUIM +	1		
RE09284F	9060530358	RETENTOR DA HASTE DE VÁLVULA	1		

• VENDE-SE AVULSO

APLICAÇÃO



IVECO TURBODAILY 1996/...
FIAT DUCATO 14 1998/01 MAXI 18 1996/02
CITROEN JUMPER II HDI 2004/...JUMPER HDI 2000/06
PEUGEOT BOXER HDI/TDI 2000/01 BOXER 4X4 HDI 2002/...
RENAULT MASTER II 1998/03
IVECO TURBODAILY 1987/89
FIAT DUCATO TD 1985/88
RENAULT TRAFIC 1997/...
IVECO DAILY 30.8/35.8 1996/...
FIAT DUCATO 14/MAXI 18 1998/01
CITROEN JUMPER 2001/02
PEUGEOT BOXER 2000/02

IVECO DUCATO 2.5 / 2.8 TURBO DIESEL

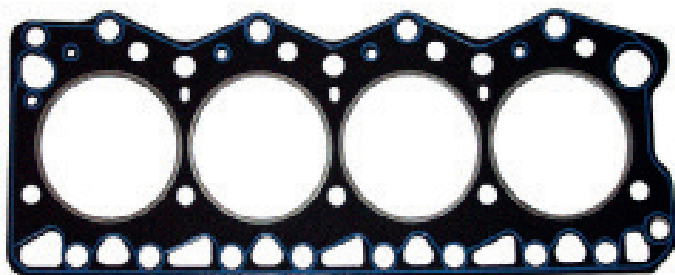

53500300

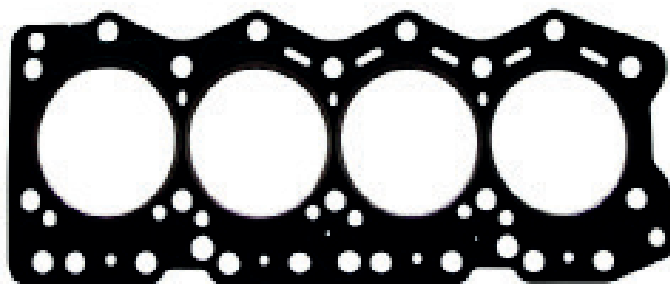

53505500

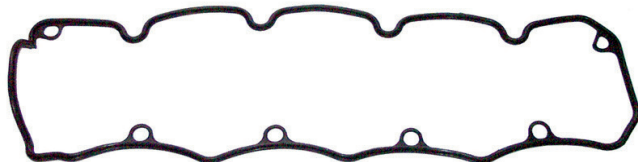

53501940



53505640

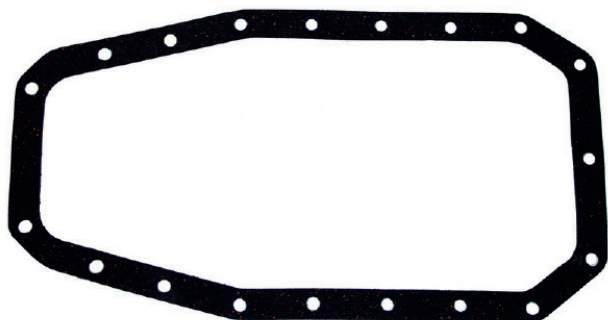

53502650

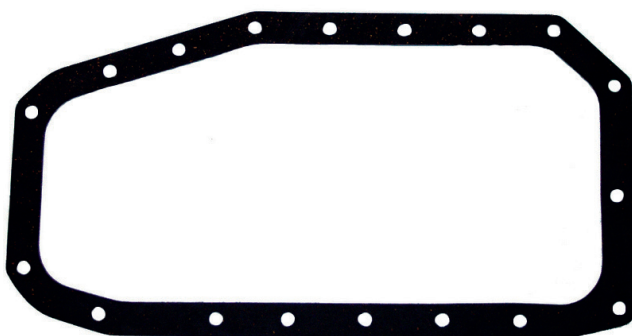

53502850



53505040



53505367

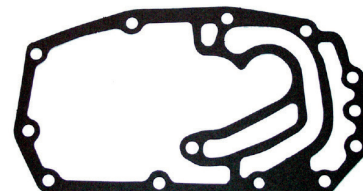

53504367



53502330

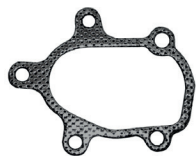

53502418

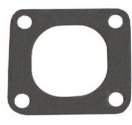

53500530



53503567



53503767



53502547



54424136



50945032



50951832



53504767



53504567



53502018



53503967

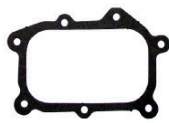

53503167

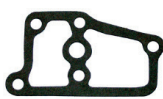

53504067



53503267



53504167



53503067

IVECO DUCATO 2.5 / 2.8 TURBO DIESEL



83500441		KIT DE BORRACHA	
Nº ABR	DESCRIÇÃO	QTD	
17281881	VEDADOR 17,2X2,6 MM	2	
17264381	VEDADOR 47,2X3,5 MM	3	
17229881	VEDADOR 9,2X1,8 MM	3	
17288481	VEDADOR 17,2X1,8 MM	4	
17281981	VEDADOR 18,7X2,6 MM	2	
14462881	VEDADOR 18,0X3,5 MM	1	
17282780	VEDADOR 22,0X1,8 MM	2	
17282281	VEDADOR 23,4X2,7 MM	1	
17282681	VEDADOR 29,7X2,7 MM	1	
17282681	VEDADOR 37,8X2,7 MM	1	
17289681	VEDADOR 44,0X3,5 MM	1	
17283881	VEDADOR 49,0X2,7 MM	1	
17280280	VEDADOR 56,9X1,8 MM	1	
17274281	VEDADOR 55,0X2,6 MM	1	
17290180	VEDADOR 59,92X3,6MM	1	
17284880	VEDADOR 64,7X2,7 MM	1	
17291381	VEDADOR 94,8X3,5 MM	1	
17291381	VEDADOR 98,0X3,5 MM	1	
14464880	VEDADOR 62,9X3,5 MM	1	
14471780	VEDADOR 66,0X5,4 MM	1	

83500241		KIT DE BORRACHA	
Nº ABR	DESCRIÇÃO	QTD	
17281881	VEDADOR 17,2X2,6 MM	1	
17281383	VEDADOR 9,2X2,6 MM	3	
17282082	VEDADOR 19,7X2,0 MM	2	
17288581	VEDADOR 18,5X1,8 MM	2	
17286882	VEDADOR 20,6X1,8 MM	2	
17282281	VEDADOR 23,4X2,7 MM	1	
17282083	VEDADOR 20,0X2,7 MM	16	
17282681	VEDADOR 29,7X2,7 MM	2	
17283881	VEDADOR 49,0X2,7 MM	1	
17280281	VEDADOR 56,9X1,8 MM	2	
17282181	VEDADOR 21,9X2,6 MM	1	
17284880	VEDADOR 64,7X2,7 MM	1	
17291381	VEDADOR 98,0X3,5 MM	1	

83500320		KIT DE BORRACHA	
Nº ABR	DESCRIÇÃO	QTD	
50015423	ARRUELA DE COBRE 10,0X13,8X1,0 MM	4	
50013022	ARRUELA DE COBRE 8,0X13,8X0,80 MM	4	
	ARRUELA DE ALUMINIO 7,0X12,6X1,6 MM	4	
50018724	ARRUELA DE COBRE 12,0X18,0X1,6 MM	4	
50021224	ARRUELA DE COBRE 14,0X20,0X1,5 MM	4	
50070324	ARRUELA DE COBRE 18,0X22,0X1,5 MM	1	
50026723	ARRUELA DE COBRE 20,0X26,0X1,0 MM	1	
	ARRUELA DE COBRE 20,0X26,0X0,70MM	1	
50072424	ARRUELA DE COBRE 22,0X27,0X1,5 MM	1	

83500120		KIT DE BORRACHA	
Nº ABR	DESCRIÇÃO	QTD	
50018723	ARRUELA DE COBRE 12,0X18,0X1,0 MM	4	
	ARRUELA DE COBRE 9,1X13,8X0,5 MM	5	
50026724	ARRUELA DE COBRE 20,0X26,0X1,5 MM	3	
50021124	ARRUELA DE ALUMINIO 14,0X18,0X1,5 MM	4	
50028724	ARRUELA DE COBRE 22,3X27,9X1,5 MM	4	
50030724	ARRUELA DE COBRE 28,3X37,4X1,5 MM	1	
50015423	ARRUELA DE COBRE 10,0X13,8X1,0 MM	2	
50015428	ARRUELA DE ALUMINIO 10,0X13,8X1,0 MM	1	

MOTOR F1AE0481C FIAT DUCATO JTD 2.3 16V

Nº JOGO		DESCRIÇÃO		
73510162		JOGO DE JUNTAS COMPLETO F1A DUCATO/PEUGEOT BOXER/RENAULT MASTER JTD 2.3 16V COM RETENTORES	1	
73530162		JOGO DE JUNTAS SUPERIOR F1A DUCATO/PEUGEOT BOXER/RENAULT MASTER JTD 2.3 16V COM RETENTORES	2	
Nº ABR	Nº ORIGINAL	DESCRIÇÃO		
53501602	500387069	JUNTA DO CABEÇOTE	1	1
53508940	504019494	JUNTA DA TAMPA DE VÁLVULA	1	1
53509040	504018307	JUNTA DO CARTER	1	1
53509130	504037859	JUNTA DO COLETOR DE ADMISSÃO	1	1
53509247	500376626	JUNTA DO COLETOR DE ESCAPAMENTO	1	1
RE09089F	RE09089F	RETENTOR COMANDO	1	1
RE09088F	RE09088F	RETENTOR DA HASTE DE VÁLVULA	16	16
RE09090T	RE09090T	RETENTOR TRASEIRO		1
RE09091T	RE09091T	RETENTOR DIANTEIRO		1
53509347	53509347	JUNTA DO TERMOSTATO	1	1
53509430	50438902	JUNTA DA TAMPA FRONTAL		1
53511640		JUNTA DA TAMPA LATERAL	1	1
53509530	53509530	JUNTA DA BASE DA TURBINA	1	1
53510130	53510130	JUNTA DO CARACOL DA TURBINA	1	1
53510231	53510231	JUNTA DO COLETOR DA TURBINA	5	5
83500740	83500740	KIT DE ARRUELAS E BORRACHAS	1	1
83500746		KIT DE BORRACHAS	1	
53511540		JUNTA DO TERMOSTATO	1	1

• VENDE-SE AVULSO

APLICAÇÃO



IVECO DAILY IV/DAILY IV COMBI/DAILY III/DAILY III COMBI 2006/...DAILY III 2002/...DAILY III/DAILY III COMBI 2005/06.

FIAT DUCATO JTD 2002/06 DUCATO JTD/DUCATO COMBI D 2006/...DUCATO JTD/DUCATO D 2009/...DUCATO D/DUCATO COMBI D 2011/...

MOTOR F1AE0481C FIAT DUCATO JTD 2.3 16V

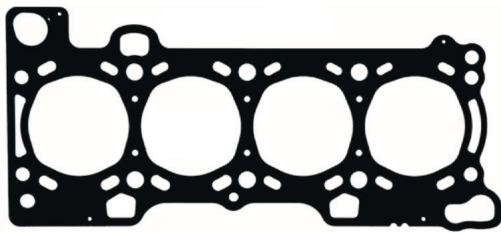

53501602



53509130

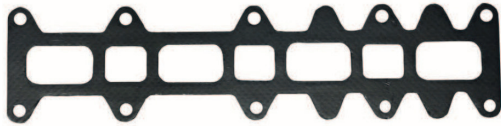

53509247

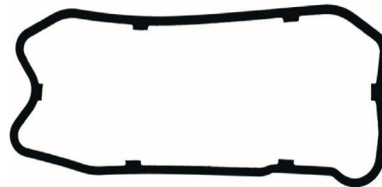

53509040

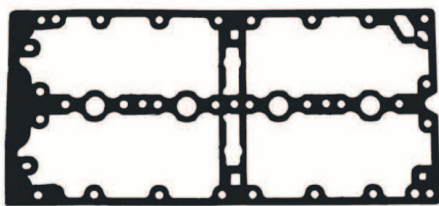

53508940



53511640



53509430



53511540



53510231



53509347



53509530



RE09090T



RE09091T



RE09089F

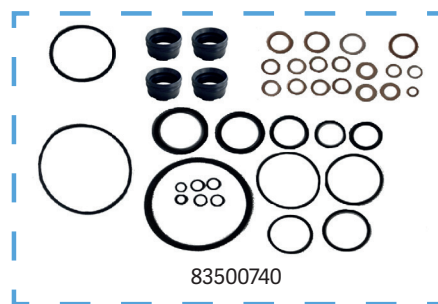

83500740



53510130



83500746



RE09088F

Nº JOGO		DESCRIÇÃO		
73510182		JOGO DE JUNTAS COMPLETO FIA DUCATO/PEUGEOT BOXER/RENAULT MASTER JTD 3.0 16V COM RETENTORES	1	
73530182		JOGO DE JUNTAS SUPERIOR FIA DUCATO/PEUGEOT BOXER/RENAULT MASTER JTD 3.0 16V COM RETENTORES	2	
Nº ABR	Nº ORIGINAL	DESCRIÇÃO		
53501302	R515273	JUNTA DO CABEÇOTE	1	1
53509640	R75729	JUNTA DO CARTER		1
53509740	R97341	JUNTA DA TAMPA DE VÁLVULA	1	1
53509847	R521439	JUNTA DO ESCAPAMENTO	1	1
53509930	R81275	JUNTA DE ADMISSÃO	1	1
53510330	R90737	JUNTA DO TUBO DO ESCAPAMENTO	2	2
RE09092T	R97352	RETENTOR DIANTEIRO		1
RE09093T	R123570	RETENTOR TRASEIRO		1
RE09088T	R135896	RETENTOR DA HASTE DE VÁLVULA	16	16
53510430	T20219	JUNTA DA TAMPA FRONTAL		1
53510231	T20243	JUNTA DO TERMOSTATO	1	1
53509347	T20273	JUNTA DA CURVA DO ESCAPAMENTO	1	1
53510547	R27285	JUNTA DO CORPO DA BORBOLETA	1	1
53510630	R97350	JUNTA DO RESFRIADOR DE ÓLEO	1	1
53510730	R97351	JUNTA DA BOMBA DE ÁGUA		1
53510830	R97354	JUNTA DA BOMBA DE ÁGUA		1
53510930	R97454	JUNTA DA TAMA DE INSPEÇÃO		1
53511030	R97455	JUNTA DO FILTRO DE ÓLEO	1	1
53511130	R90648	JUNTA DO FILTRO DE ÓLEO	1	1
53511330	T20328	JUNTA DO RESFRIGERADOR		1
53511430		JUNTA VAL ERGONOMICA	1	2
83500840		KIT DE ARRUELA E BORRACHA	1	1
53511830		JUNTA DA BOMBA DE ÁGUA		1
53511540		JUNTA DO TERMOSTATO	1	

• VENDE-SE AVULSO

APLICAÇÃO



IVECO DAILY IV/DAILY IV COMBI 2007/...

FIAT DUCATO JTD 2006/...DUCATO/DUCATO COMBI 2010/...

CITROEN JUMPER III HDI 2008/...

PEUGEOT BOXER 3 HDI 2006/...MANAGER HDI 2010/...

MT F1CE0481D FIAT DUCATO 3.0 16V

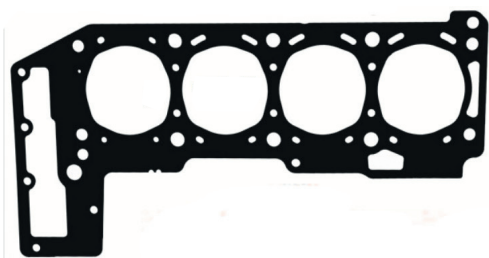

53501302



53509930

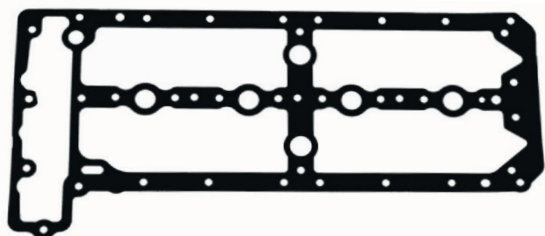

53509740



53509847

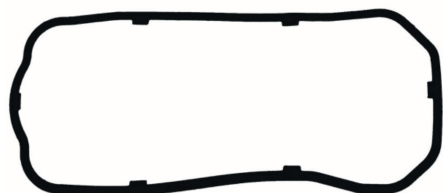

53509640



53511540

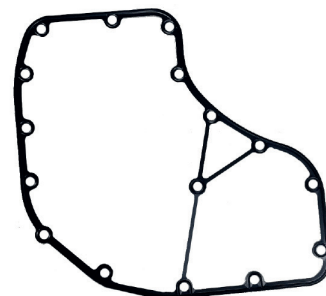

53510430



53510830



53511130



53511830



53510930



53510730



53511030



53511330



53510547



53510630



53510547



535511430



53510330



53509347



RE09093T



RE09092T



RE09088F

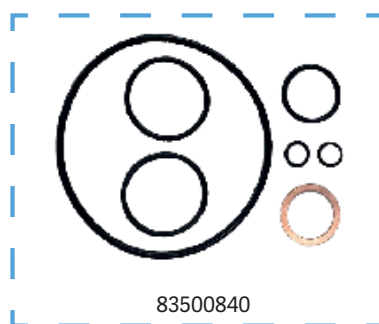

83500840

Nº JOGO		DESCRIÇÃO		
73510202		JOGO DE JUNTAS COMPLETO IVECO CURSOR 8 COM RETENTORES	1	
73530202		JOGO DE JUNTAS SUPERIOR IVECO CURSOR 8 COM RETENTORES	2	
Nº ABR	Nº ORIGINAL	DESCRIÇÃO		
53516702	504385500	JUNTA DO CABEÇOTE	1	1
RE09126	40101573	RETENTOR HASTE DA VÁLVULA	24	24
53512440	99446692	JUNTA DA TAMPA DE VÁLVULA	1	1
53515640	504200838	JUNTA DO CARTER		1
RE09131T	504042683	RETENTOR VIRABREQUIM TRASEIRO		1
RE09132T	504042684	RETENTOR VIRABREQUIM DIANTEIRO		1
53515030	504045791	JUNTA DA DISTRIBUIÇÃO	1	1
53514404	500383043	JUNTA DO RESPIRO DO FILTRO DE ÓLEO		2
53512130	98451118	JUNTA DO TURDO		1
53516530	504375264	JUNTA DO COLETOR DE ADMISSÃO	2	2
53516647	504380076	JUNTA DA COLETOR DE ESCAPE	6	6
53515367	504149689	JUNTA DO TUBO DA BOMBA DE ÓLEO		1
53517230	500364380	JUNTA DO TUBO DE SUCÇÃO		1
53517330	500364892	JUNTA DO TUBO DE SUCÇÃO		2
53514830	504045785	JUNTA DO TERMOSTATO	1	1
53512730	98497873	JUNTA DO RESPIRADOE DO ÓLEO		1
53513940	500383038	JUNTA DA DISTRIBUIÇÃO		1
53514930	504045790	JUNTA DA TAMPA DO BLOCO	1	1
53512530	99447382	JUNTA DA TAMPA TRASEIRA		1
53513130	9944779999	JUNTA DA TUBULAÇÃO DE ÁGUA		1
53513630	500364603	JUNTA DA CONEXÃO DA BOMBA DE ÁGUA		1
53514730	504015752	JUNTA SUPERIOR DO FILTRO DE ÓLEO		1
53512330	99442502	JUNTA SUPERIOR DO FILTRO DE ÓLEO		1
53512067	504360820	JUNTA DA ENTRADA DE ÓLEO DO TURBO		2
RE09134T	504045790	RETENTOR DO TERMOSTATO		1
83500940		KIT DE BORRCHA		1
83501040		KIT DE BORRACHA SUPEIOR	1	1
83501426		KIT DE ARRUELAS		1

• VENDE-SE AVULSO

APLICAÇÃO



IVECO FPT F2B CURSOR 8 6 CIL 7.8L EURO 5

IVECO TRUCK EURO CARGO CAVALLINO 450E32 2007/12 180E32 2006/...

MOTOR IVECO CURSOR 8

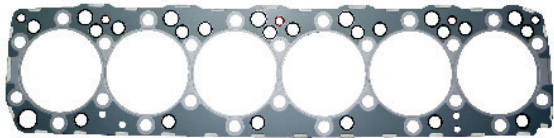

53516702



53515640

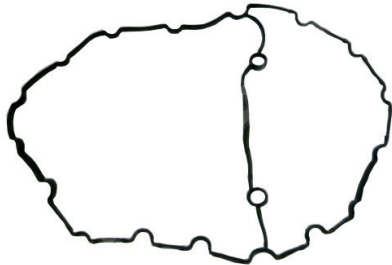

53513940

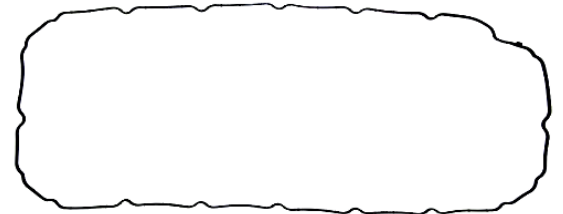

53512440



53512330



53514730



53514930



53515030



53514830



53513130

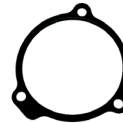

53512530



53513630



53512130



53516647



53516530

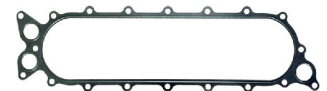

53512730



53515367



53517230



53517330



53512067



RE09132T



RE09134T



RE09131T



RE09126

Nº JOGO		DESCRIÇÃO		
73510252		JOGO DE JUNTAS COMPLETO IVECO CURSOR 9 COM RETENTORES	1	
73530252		JOGO DE JUNTAS SUPERIOR IVECO CURSOR 9 COM RETENTORES	2	
Nº ABR	Nº ORIGINAL	DESCRIÇÃO		
53516702	504385500	JUNTA DO CABEÇOTE	1	1
53516702	504366703	RETENTOR DA HASTE DE VÁLVULA	24	24
53512440	99446692	JUNTA DA TAMPA DE VÁLVULA	1	1
53516440	504346309	JUNTA DO CARTER		1
RE09130T	40102693	RETENTOR DO VIRABREQUIM TRASEIRO		1
RE09132T	504042684	RETENTOR DO VIRABREQUIM DIANTEIRO		1
53516230	504314384	JUNTA DO NÍVEL DE ÓLEO		1
53516130	504312666	JUNTA DO FREIO DO MOTOR		1
53515230	504147366	JUNTA DO FILTRO DE ÓLEO		1
53517040	336432A1	JUNTA DO FILTRO DO SEPARADOR DE ÓLEO		1
53512130	98451118	JUNTA DO TURBO		1
53516530	504375264	JUNTA DO COLETOR DE ADMISSÃO	2	2
53516647	504380076	JUNTA DO COLETOR DO ESCAPE	6	6
53515367	504149689	JUNTA DO TUBO DA BOMBA DE ÓLEO		1
53516330	504331011	JUNTA DO RETORNO DE ÓLEO DO TURBO		1
53512067	504360820	JUNTA DA ENTRADA DE ÓLEO DO TURBO		1
53514830	504045785	JUNTA DO TERMOSTATO	1	1
53514930	504054790	JUNTA DA TAMPA DO BLOCO	1	1
53515130	504128027	JUNTA DO RESFRIADOR DE ÓLEO		1
RE09134T	98494952	RETENTOR TERMOSTATO		1
53512530	99447382	JUNTA DA TAMPA TRASEIRA		1
53516830	5801596032	JUNTA DA BOMBA DE ALTA PRESSÃO		1
83500940		KIT DE BORRACHA		1
83501040		KIT DE BORRACHA SUPERIOR	1	1
83501426		KIT DE ARRUELAS		1

• VENDE-SE AVULSO

APLICAÇÃO



IVECO FPT F2C CURSOR 9 6 CIL 8.7L EURO 5

IVECO TRUCK CURSOR 450E33 2009/12 STRALLIS 450S33/500S33 2013/15 460S36 2012/...530S36 2013/15

NEW HOLLAND TRACTOR T8270/T8295/T8325/T8355/T8385 2011/...COLHEITADEIRA CR9060 2010/16 CR6.80 EVO/CR7.80 EVO 2017/...

CASE TRACTOR STEIGER 370 2012/...MAGNUM 235/240/260/270/290/315 2006/...340/380 2011/...

CASE COLHEITADEIRA AF7120 2010/14 AF6130/AF7130 2016/...AF7230 2013/...A8000/A8800 2009/...

IVECO CURSOR 9

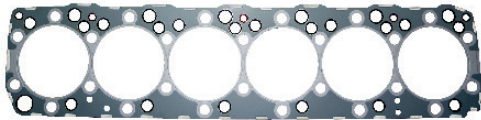

53516702



53515130

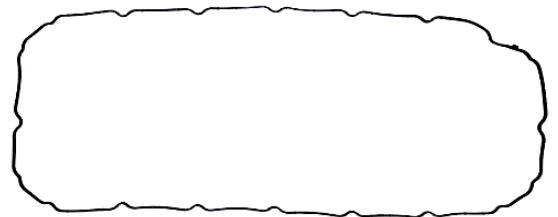

53512440



53516440

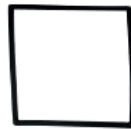

53517040



53516130



53515367



53516230



53516330



53512067



53516830



53516447



53512130

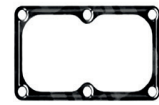

53516530



53514830



53514830



53512530



5351230



RE09130T



RE09132T



RE09134T



RE09133F

Nº JOGO		DESCRIÇÃO		
73510352		JOGO DE JUNTAS COMPLETO IVECO CURSOR 10 COM RETENTORES		1
73530352		JOGO DE JUNTAS SUPERIOR IVECO CURSOR 10 COM RETENTORES		2
Nº ABR	Nº ORIGINAL	DESCRIÇÃO		
53515740	504262851	JUNTA DO CARTER		1
RE09130T	40102693	RETENTOR VIRABREQUIM TRASEIRO		1
53512630	99448739	JUNTA DO TERMOSTATO	1	1
RE09129T	40102683	RETENTOR VIRABREQUIM DIANTERIO		1
53513840	500382999	JUNTA DA DISTRIBUIÇÃO		1
53513940	500383038	JUNTA DA DISTRIBUIÇÃO		1
53514147	500383189	JUNTA DA TAMPA TRASEIRA		1
53514540	500398649	JUNTA DO RESPIRO FILTRO ÓLEO		1
53514040	500383043	JUNTA DO RESPIRO FILTRO ÓLEO		2
53514402	500396535	JUNTA DO CABEÇOTE		1
RE09127F	40101584	RETENTOR DA HASTE DE VÁLVULA	24	24
53513340	500323989	JUNTA DA TAMPA DE VÁLVULA	1	1
53515547	504154279	JUNTA DO COLETOR DE ESCAPE	6	6
53513730	500370033	JUNTA DO TERMOSTATO	1	1
53516530	504375264	JUNTA DO COLETOR DE ADMISSÃO	2	2
53512130	98451118	JUNTA DO TURBO		1
53513030	99475979	JUNTA DO RETORNO DE ÓLEO DO TURBO		1
53512830	99452273	JUNTA DA CONEXÃO DA BOMBA DE ÓLEO		1
53514730	504015752	JUNTA DO SUPERIOR DO FILTRO DE ÓLEO		1
53513430	500343518	JUNTA DO TUBO DA BOMBA DE ÓLEO		1
53512730	98497873	JUNTA DO RESFRIADOR DE ÓLEO		1
53512930	99466940	JUNTA DA TUBULAÇÃO DE ÁGUA		1
53513530	500362150	JUNTA DO TERMOSTATO	1	1
53512530	99447382	JUNTA DA BOMBA DE ÓLEO		1
RE09134T	98494952	RETENTOR DO TERMOSTATO		2
53515367	504149689	JUNTA DO TUBO DA BOOMBA DE ÓLEO		1
83501140		KIT DE BORRACHA		1
83501240		KIT DE BORRACHA SUPERIOR	1	1
83501626		KIT DE ARRUELAS		1

● VENDE-SE AVULSO

APLICAÇÃO



IVECO FPT F3A CURSOR 10 6 CIL 10.3L EURO 5

FORD TRUCK CARGO 2042E/2842E 2013/...

NEW HOLLAND COLHEITADEIRA CR7.90 EVO 2017/...

CASE COLHEITADEIRA 8120 2010/15

MOTOR IVECO CURSOR 10

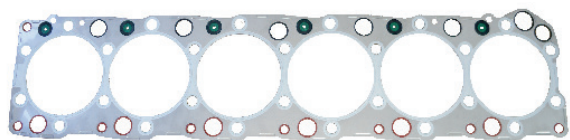

53514402

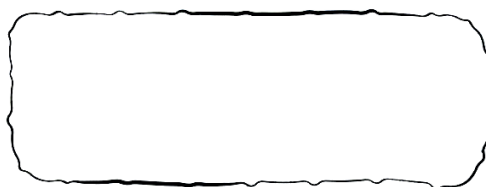

53513340

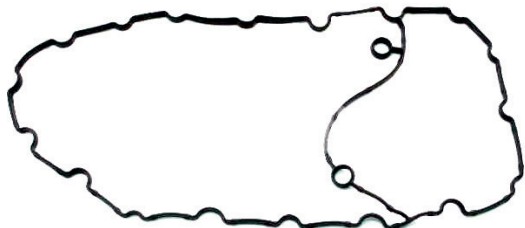

53513840

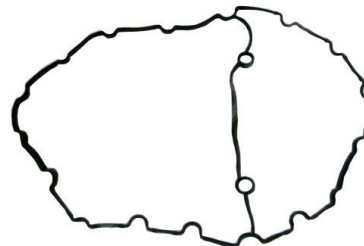

53513940



53514040

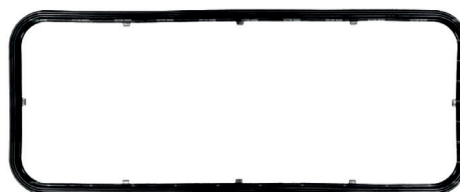

53515740



53512730



53514147



53514730

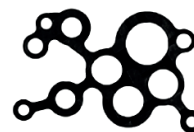

53512830



53513530



53513730



53512130



53516530



53512930

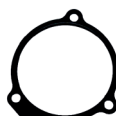

53512530



53512630



53514540



53515367



53513030



53513430



53515547



RE09129T



RE09130T



RE03134T



RE09129T

Nº JOGO		DESCRIÇÃO		
73510302		JOGO DE JUNTAS COMPLETO IVECO CURSOR 13 COM RETENTORES		1
73530302		JOGO DE JUNTAS SUPERIOR IVECO CURSOR 13 COM RETENTORES		2
Nº ABR	Nº ORIGINAL	DESCRIÇÃO		
503814840	504024777	JUNTA DO CARTER		1
RE09130T	40102693	RETENTOR VIRABREQUIM TRASEIRO		1
53512630	99448739	JUNTA DO TERMOSTATO		1 1
RE09129T	40102683	RETENTOR VIRABREQUIM DIANTEIRO		1
53513840	500382999	JUNTA DA DISTRIBUIÇÃO		1
53514147	500383189	JUNTA DA TAMPA TRASEIRA		1
53514540	500398649	JUNTA DO RESPIRO DO FILTRO DE ÓLEO		1
53514040	500383043	JUNTA DO RESPIRO DO FILTRO DE ÓLEO		2
53514602	504007514	JUNTA DO CABEÇOTE		1 1
RE09128F	40101874	RETENTOR DA HÁSTE DE VÁLVULAS		24 24
53513240	500309014	JUNTA DA TAMPA DE VÁLVULA		1 1
53515447	504154280	JUNTA DO COLETOR DE ESCAPE		6 6
53513730	500370033	JUNTA DO TERMOSTATO		1 1
53516530	504375264	JUNTA DO COLETOR DE ADMISSÃO		2 3
53512230	98453300	JUNTA DO TURBO		1
53514230	500387050	JUNTA DO TURBO		1
53511967	61318303	JUNTA DO RETORNO DE ÓLEO DO TURBO		1
53513030	99475979	JUNTA DO RETORNO DE ÓLEO DO TURBO		1
53512830	99452273	JUNTA DA CONEXÃO DA BOMBA DE ÓLEO		1
53514330	500387958	JUNTA DA CONEXÃO DA BOMBA DE ÓLEO		1
53514730	504015752	JUNTA SUPERIOR DO FILTRO DE ÓLEO		1
53513430	500343518	JUNTA DO TUBO DA BOMBA DE ÓLEO		1
53517130	500388968	JUNTA DA CONEXÃO DA BOMBA DE ÓLEO		1
53512730	98497873	JUNTA DO RESFRIADOR DE ÓLEO		1
53512930	9946640	JUNTA DA TUBULAÇÃO DE ÁGUA		1
53513530	500362150	JUNTA DO TERMOSTATO		1 1
53512530	99447382	JUNTA DABOMBA DE ÓLEO		1
RE09134T	98494952	RETENTOR DO TERMOSTATO		2
53515367	504149689	JUNTA DO TUBO DA BOMBA DE ÓLEO		1
53512067	504360820	JUNTA DA ENTRADA DE ÓLEO DO TURBO		1
83501340		KIT DE BORRACHA		1
83501240		KIT DE BORRACHA SUPERIOR		1 1
83501526		KIT DE ARRUELAS		1

• VENDE-SE AVULSO

MOTOR IVECO CURSOR 13

APLICAÇÃO



IVECO FPT F3B CURSOR 13 6 CIL 12.9L EURO 5

IVECO TRUCK EUROTECH 740E42 2002/06 TRACKER 380T38 2008/11 380T42/720T42 2008/12 410T48/740T48 2013/17

STRALLIS 450S38 2005/09 490S38 2008/12 570S38 2006/12 490S40 2012/...600S40 2013/...490S41/570S41/740S41 2010/12

450S42 2006/07 490S42 2008/10 570S42 2006/10 740S42 2006/10 490S44/600S44/800S44 2013/...490S46/570S46/740S46 2010/12

490S48T 2013/15 600S48/800S48 2013/...600S56 2013/15 800S/56 2013/...EUOTRAKKER 380E38 2004/09 720E42 2004/09

NEW HOLLAND TRACTOR T9480/T9530/T9560/T9600/T9700 2012/...COLHEITADEIRA CR8090 2011/17 CR9090 2013/16

CR9080 2011/16 CR8.90 EVO 2017/...

CASE TRACTOR STEIGER 420/470/500/540/550/580/620 2012/...COLHEITADEIRA AF8230/9230 2013/...

MOTOR IVECO CURSOR 13



53514602

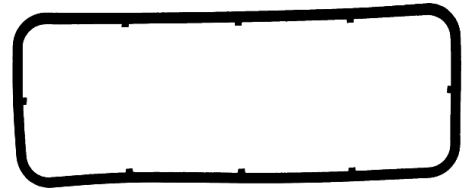

53514840

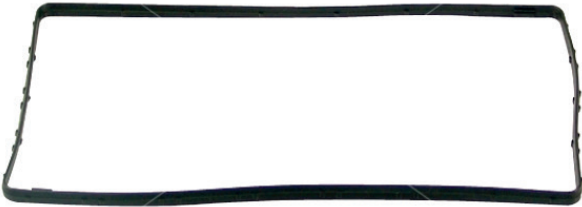

53514040

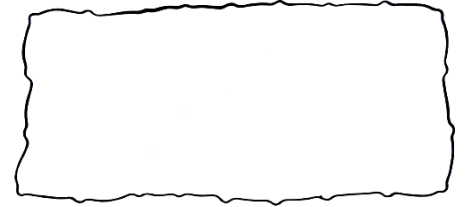

50918655

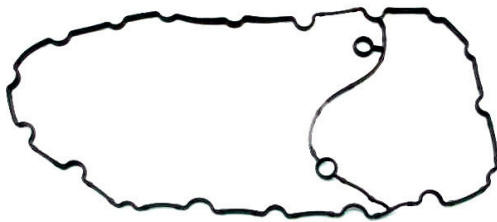

53514147



53514540



53514730



53512830



53514330



53513530



53512230



53512230



53513730



53512630

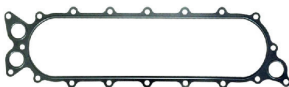

53512730



53513840



53512530



53514230

MOTOR IVECO CURSOR 13



53515367



53513030



53511967



53512067



53513430



53517130



53512930



53515447



RE09129T



RE09130T



RE09134T



RE09128F

The Scania logo is centered on the page. It consists of a stylized symbol on the left, which is a blue parallelogram with two white diagonal lines, followed by the word "SCANIA" in a bold, blue, sans-serif typeface.

SCANIA

SCANIA

Nº ABR	MOTOR	DESCRIÇÃO		PÁGINA
73716300	DN11/DS11	JOGO DE JUNTAS COMPLETO	COM RETENTORES COM ANÉIS DE CAMISA	204
63714745	DN11/DS11	JOGO DE JUNTAS COMPLETO	SEM RETENTORES SEM ANÉIS DE CAMISA	204
73714745	DN11/DS11	JOGO DE JUNTAS COMPLETO	COM RETENTORES COM ANÉIS DE CAMISA	204
63734745	DN11/DS11	JOGO DE JUNTAS SUPERIOR	SEM RETENTORES SEM ANÉIS DE CAMISA	204
73796310	DS11/DSC11	JOGO DE JUNTAS COMPLETO	SEM RETENTORES SEM ANÉIS DE CAMISA	208
63796315	DS11/DSC11	JOGO DE JUNTAS COMPLETO	COM RETENTORES SEM ANÉIS DE CAMISA	208
73796315	DS11/DSC11	JOGO DE JUNTAS SUPERIOR	COM RETENTORES COM ANÉIS DE CAMISA	208
63736345	DS11/DSC11	JOGO DE JUNTAS SUPERIOR	SEM RETENTORES SEM ANÉIS DE CAMISA	208
73710430	DN11/DS11/DSC11	JOGO DE JUNTAS COMPLETO	COM RETENTORES COM ANÉIS DE CAMISA	212
63710435	DN11/DS11/DSC11	JOGO DE JUNTAS COMPLETO	SEM RETENTORES SEM ANÉIS DE CAMISA	212
73710435	DN11/DS11/DSC11	JOGO DE JUNTAS COMPLETO	COM RETENTORES SEM ANÉIS DE CAMISA	216
63730435	DN11/DS11/DSC11	JOGO DE JUNTAS SUPERIOR	SEM RETENTORES SEM ANÉIS DE CAMISA	216
63710129	DC11	JOGO DE JUNTAS COMPLETO	SEM RETENTORES COM ANÉIS DE CAMISA	220
73710129	DC11	JOGO DE JUNTAS COMPLETO	COM RETENTORES COM ANÉIS DE CAMISA	220
63710429	DSC12	JOGO DE JUNTAS COMPLETO	SEM RETENTORES COM ANÉIS DE CAMISA	220
73710429	DSC12	JOGO DE JUNTAS COMPLETO	COM RETENTORES COM ANÉIS DE CAMISA	220
63710109	DSC12	JOGO DE JUNTAS COMPLETO	SEM RETENTORES COM ANÉIS DE CAMISA	220
73710109	DSC12	JOGO DE JUNTAS COMPLETO	COM RETENTORES COM ANÉIS DE CAMISA	220
63730121	DC11	JOGO DE JUNTAS MONOCILÍNDRICO	SEM RETENTORES SEM ANÉIS DE CAMISA	224
73730121	DC11	JOGO DE JUNTAS MONOCILÍNDRICO	COM RETENTORES SEM ANÉIS DE CAMISA	224
63730421	DSC12	JOGO DE JUNTAS MONOCILÍNDRICO	SEM RETENTORES SEM ANÉIS DE CAMISA	224
73730421	DSC12	JOGO DE JUNTAS MONOCILÍNDRICO	COM RETENTORES SEM ANÉIS DE CAMISA	224
63730101	DSC12	JOGO DE JUNTAS MONOCILÍNDRICO	SEM RETENTORES SEM ANÉIS DE CAMISA	224
73730101	DSC12	JOGO DE JUNTAS MONOCILÍNDRICO	COM RETENTORES SEM ANÉIS DE CAMISA	224
73712535	DS14/LK140/LK141	JOGO DE JUNTAS COMPLETO	COM RETENTORES SEM ANÉIS DE CAMISA	226
63732535	DS14/LK140/LK141	JOGO DE JUNTAS MONOCILÍNDRICO	SEM RETENTORES SEM ANÉIS DE CAMISA	226

DN11/DS11 6 CILINDROS 11 LITROS (SERIE 2)

Nº JOGO	DESCRIÇÃO	
73716300	JOGO DE JUNTAS COMPLETO DN11 / DS11 COM RETENTORES COM ANÉIS DE CAMISA	1
63714745	JOGO DE JUNTAS COMPLETO DN11 / DS11 SEM RETENTORES SEM ANÉIS DE CAMISA	2
73714745	JOGO DE JUNTAS COMPLETO DN11 / DS11 COM RETENTORES SEM ANÉIS DE CAMISA	3
63734745	JOGO DE JUNTAS COMPLETO DN11 / DS11 SEM RETENTORES SEM ANÉIS DE CAMISA	4

Nº ABR	Nº ORIGINAL	DESCRIÇÃO				
53702867	35161	JUNTA DO CANO DE ÁGUA	1	1	1	1
53702967	35309	JUNTA DO RESPIRO DO TUCHOS	1	1	1	1
53704850	131103	JUNTA DA TAMPA DE VÁLVUVAS	2	2	2	2
53704990	131131	JUNTA DA FLANGE DO CABEÇOTE	1	1	1	1
53705090	131133	JUNTA DO TERMOSTATO	2	2	2	2
53705167	131166	JUNTA DA TAMPA LATERAL	2	2	2	2
53705267	287554	JUNTA DA TRASEIRA DA DISTRIBUIÇÃO	1	1	1	1
53705667	139274	JUNTA DA CARÇAÇA DA DISTRIBUIÇÃO	1	1	1	1
53705790	277632	JUNTA DO COLETOR DE ADMISSÃO	2	2	2	2
53706567	287555	JUNTA DO CARÇAÇA DO VOLANTE	1	1	1	1
53706667	139044	JUNTA DA TAMPA DA CARÇAÇA DO TERMOSTATO	1	1	1	1
53706867	277637	JUNTA DO ABAFADOR	1	1	1	1
53706985	139123	JUNTA DO SUPORTE DO BALANCINS	6	6	6	6
53707090	139144	JUNTA DA TAMPA DE DISTRIBUIÇÃO	1	1	1	1
53707165	139146	JUNTA DA DIANTEIRA DO VIRABREQUIM	1	1	1	1
53707265	139149	JUNTA DA TRASEIRO DO VIRABREQUIM	1	1	1	1
53707567	1675602	JUNTA DA TAMPA DE DISTRIBUIÇÃO	1	1	1	1
53708667	162142	JUNTA DO TAMPA DE FIXAÇÃO	1	1	1	1
53709490	2155242	JUNTA DO CARTER	1	1	1	1
53709770	238775	JUNTA DA TAMPA DA BOMBA DE ÓLEO	1	1	1	1
53710030		JUNTA DO TRAVA DO VOLANTE PEQUENO	3	3	3	3
53710130		JUNTA DO TRAVA DAS BIELAS	1	1	1	1
53710630		JUNTA DA TRAVA DO VOLANTE	1	1	1	1
53710967	131236	JUNTA DO CARÇAÇA DA BOMBA DE ÁGUA	1	1	1	1
53714867	170765	JUNTA DO FILTRO ROTATIVO	1	1	1	1
53715067	232961	JUNTA DO FILTRO DE ÓLEO	1	1	1	1
53715117	131294	JUNTA DO COLETOR DO ESCAPAMENTO	2	2	2	2
53715217	131295	JUNTA DO COLETOR DO ESCAPAMENTO	2	2	2	2
53715367	235610	JUNTA DO VEDAÇÃO	1	1	1	1
53715467	238148	JUNTA DO TAMPA DO TERMOSTATO	1	1	1	1
53715567	283403	JUNTA DO FILTRO ROTATIVO ÓLEO	1	1	1	1
53717467	238309	JUNTA DO ABAFADOR	1	1	1	1
53717667	272793	JUNTA DA TAMPA LATERAL DO CARTER				
53723616	1109288	JUNTA DO COLETOR DE ESCAPAMENTO		2		
53723716	378264	JUNTA DO COLETOR DE ESCAPAMENTO		2		
53725105	373472	JUNTA DO CABEÇOTE	2	2	2	2
53725267	292759	JUNTA DO TUBO DA EANTRADA DE ÁGUA	1	1	1	1
53725790	1675584	JUNTA DO COLETOR DE ADMISSÃO				
53725890	1675583	JUNTA DO COLETOR DE ADMISSÃO				
53725967	295050	JUNTA DO TERMOSTATO				
53726067		JUNTA DA VEDAÇÃO				
53726167	371238	JUNTA DO COMPRESSOR	1	1	1	1
53726267	338332	JUNTA DO CONJUNTO DE ADMISSÃO				
53726367	277633	JUNTA DA TAMPA LATERAL				
53726467	287334	JUNTA DO TERMOSTATO				
53726567	287559	JUNTA DO RESPIRO DO MOTOR				
53726667		JUNTA DA VEDAÇÃO				
53726767		JUNTA DA VEDAÇÃO	1	1	1	1
53729245		JUNTA DO ANÉL DE CAMISA	18			18
53754440	1302828	JUNTA DA CINTA DE CAMISA				
83727526		KIT DE ARRUELAS SUPERIOR				
83727629		KIT DE ARRUELAS	1	1	1	1
83727741		KIT DE BORRACHAS	1	1	1	1
RE02069S		RETENTOR TRASEIRO	1	1		1
RE02235S		RETENTOR DIANTEIRO	1	1		1

● RVENDE-SE AVULSO

DN11/DS11 6 CILINDROS 11 LITROS (SERIE 2)

APLICAÇÃO

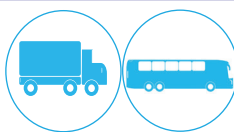

SCANIA DN11/DS11 6 CIL 11L(SERIE 2)

SCANIA CAMINHÃO 112H 1982/86 ; 112HS 1987/89 ; 112HW 1989/91

SCANIA ÔNIBUS S112/K112 1983/91

SCANIA DS11/DSC11 6 CIL 11L(SERIE 3)

SCANIA CAMINHÃO R113E/R113H 1991/98 ; T113E/T113H 1991/98

SCANIA ÔNIBUS S113 1991/93 ; L113 1993/98 ; K113 1994/98

DN11/DS11 6 CILINDROS 11 LITROS (SERIE 2)

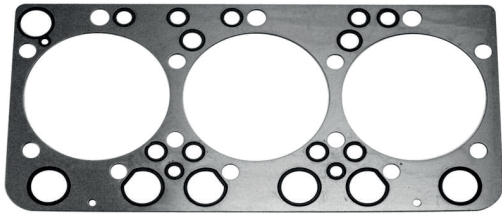

54725105

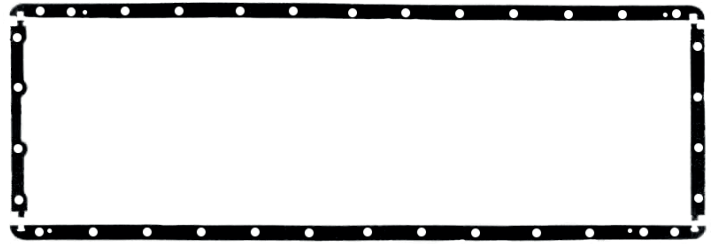

53709490

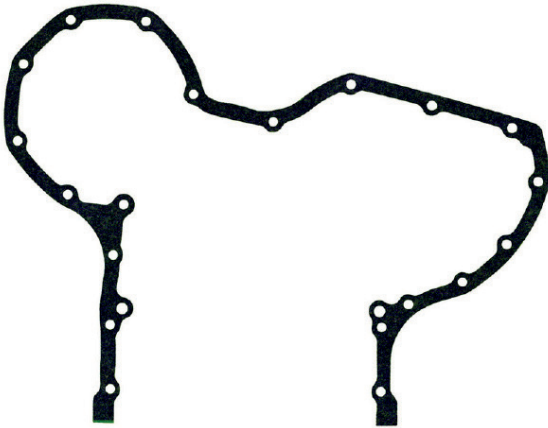

53707567

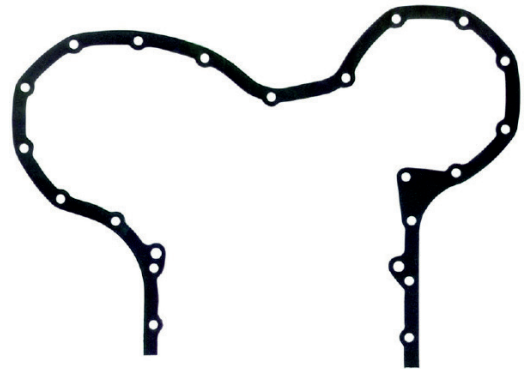

53707090

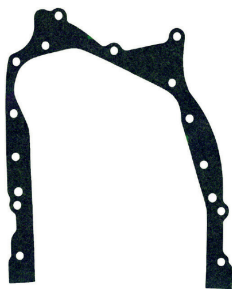

53705267



53706567

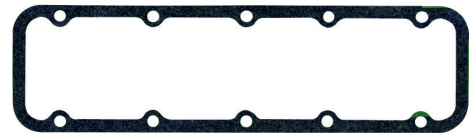

53704850

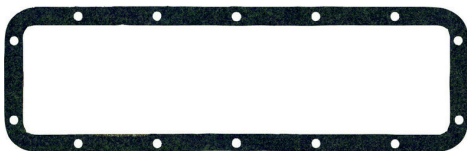

53705167

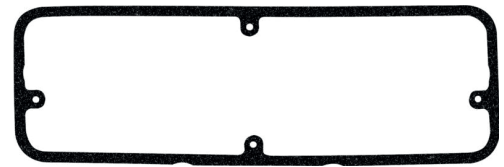

53704850

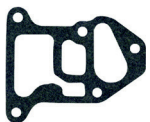

53715567



53705090



53710030



53710130



53710630



53725790

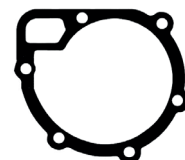

53710967

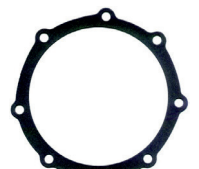

53708667



RE02235S



53707165



RE02069S



53707265

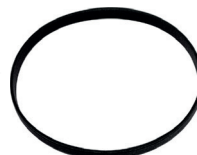

53754440

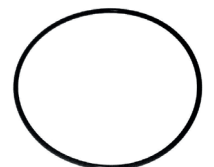

53729245

DN11/DS11 6 CILINDROS 11 LITROS (SERIE 2)

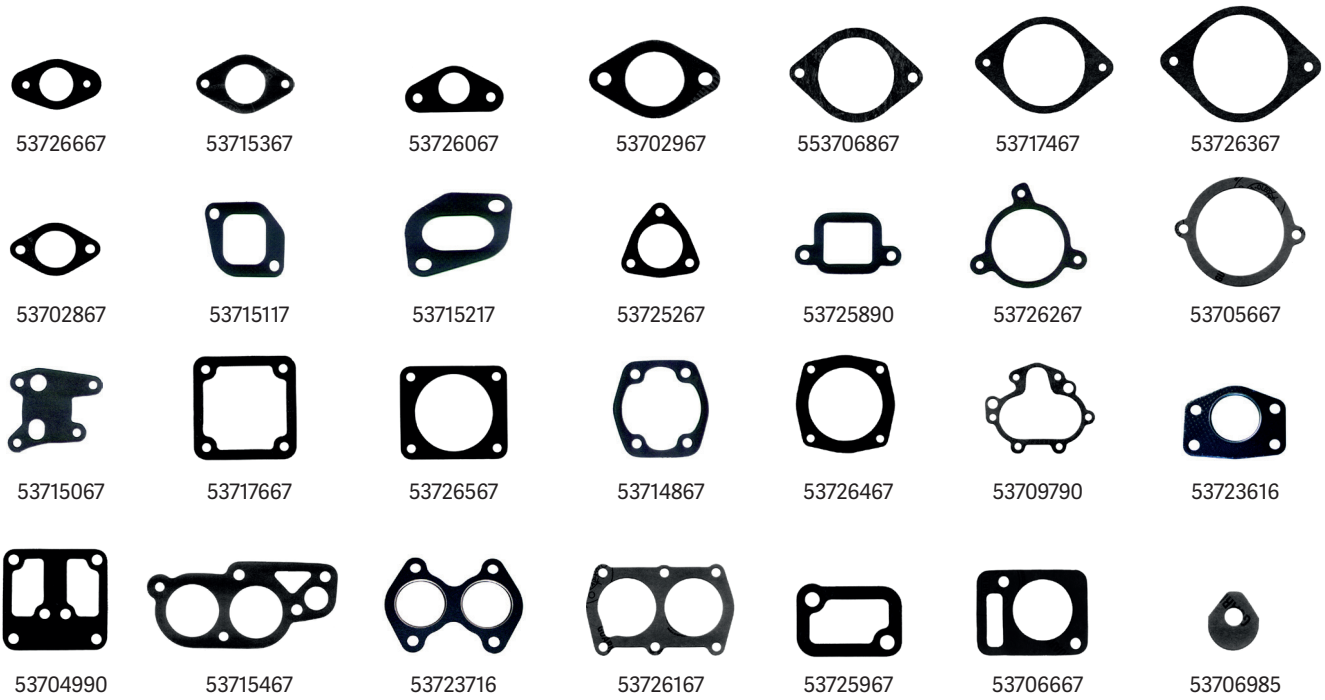

83727741 KIT DE BORRACHAS			
Nº ABR	DESCRIÇÃO	QTD	
50028141	VEDADOR 106,7 X 3,5 MM	1	
50027941	VEDADOR 106,5 X 2,1 MM	1	
50005741	VEDADOR 20,0 X 4,0 MM	3	
50010941	VEDADOR 26,0 X 3,2 MM	2	
50009141	VEDADOR 59,0 X 3,4 MM	1	
50028841	VEDADOR 126,0 X 5,0 MM	1	
50029141	VEDADOR 135,0 X 2,8 MM	2	
50030741	VEDADOR 43,5,0 X 3,4 MM	2	
50031441	VEDADOR 53,0 X 3,3 MM	2	
50034241	VEDADOR 10,2 X 3,2 MM	1	
50035841	VEDADOR 41,5 X 56,3 X 3,5 MM	1	
50036941	VEDADOR 13,0 X 2,5 MM	2	
50039641	VEDADOR 16,0 X 2,4 MM	1	
50040541	VEDADOR 19,0 X 3,2 MM	3	
50054541	VEDADOR 34,5 X 46,0 X 2,5 MM	1	
50055141	VEDADOR 18,0 X 29,0 X 4,3 MM	4	
50026841	VEDADOR 74,2 X 3,5 MM	2	
53702441	VEDADOR TERMOSTATO	1	
53751041	VEDADOR TAMPA VÁLVULA	4	

83727629 KIT DE ARRUELAS			
Nº ABR	DESCRIÇÃO	QTD	
50011323	ARRUELA COBRE 8,3 X 13,8 X 1,0 MM	1	
50083330	ARRUELA AÇO 9,5 X 20,0 X 2,0 MM	6	
50021229	ARRUELA ALUMÍNIO 14,0 X 20,0 X 1,5 MM	10	
50018529	ARRUELA ALUMÍNIO 12,0 X 16,0 X 1,5 MM	8	
50012223	ARRUELA COBRE 8,0 X 12,0 X 1,0 MM	14	
50071228	ARRUELA ALUMÍNIO 26,4 X 33,7 X 1,0 MM	1	
50025829	ARRUELA ALUMÍNIO 18,0 X 24,0 X 1,0 MM	1	
50015528	ARRUELA ALUMÍNIO 10,0 X 16,0 X 1,0 MM	12	
	ARRUELA COBRE 10,2 X 21,3 X 1,8 MM	6	
50015429	ARRUELA ALUMÍNIO 10,0 X 14,0 X 1,5 MM	4	
50026728	ARRUELA ALUMÍNIO 20,0 X 26,0 X 1,0 MM	2	

83727526 KIT DE ARRUELA SUPERIOR			
Nº ABR	DESCRIÇÃO	QTD	
50014123	ARRUELA COBRE 9,5 X 20,0 X 1,0 MM	6	
50002129	ARRUELA ALUMÍNIO 14,0 X 20,0 X 1,5 MM	4	
50018529	ARRUELA ALUMÍNIO 12,0 X 16,0 X 1,5 MM	8	
50012223	ARRUELA COBRE 8,0 X 12,0 X 1,0 MM	14	

DS11/DSC11 6 CILINDROS 11 LITROS (SÉRIE 3)

Nº JOGO	DESCRIÇÃO	
73796310	JOGO DE JUNTAS COMPLETO DS11/DSC11 SEM RETENTORES SEM ANÉIS DE CAMISA	1
63796315	JOGO DE JUNTAS COMPLETO DS11/DSC11 COM RETENTORES SEM ANÉIS DE CAMISA	2
73796315	JOGO DE JUNTAS SUPERIOR DS11/DSC11 COM RETENTORES COM ANÉIS DE CAMISA	3
63736345	JOGO DE JUNTAS SUPERIOR DS11/DSC11 SEM RETENTORES SEM ANÉIS DE CAMISA	4

Nº ABR	Nº ORIGINAL	DESCRIÇÃO				
53702867	35161	JUNTA DO CANO DE ÁGUA	1	1	1	1
53702967	35309	JUNTA DO RESPIRO TUCHOS	1	1	1	1
53704850	131103	JUNTA DA TAMPA DE VÁLVUVAS	2	2	2	2
53704990	131131	JUNTA FLANGE DO CABEÇOTE	1	1	1	1
53705090	131133	JUNTA DO TERMOSTATO	2	2	2	2
53705167	131166	JUNTA DA TAMPA LATERAL	2	2	2	2
53705267	287554	JUNTA DA TRASEIRA DE DISTRIBUIÇÃO	1	1	1	1
53705667	139274	JUNTA DA CARÇAÇA DE DISTRIBUIÇÃO	1	1	1	1
53705790	277632	JUNTA DO COLETOR DE ADMISSÃO	2	2	2	2
53706567	287555	JUNTA DA CARÇAÇA DO VOLANTE	1	1	1	1
53706667	139044	JUNTA DA TAMPA DA CARÇAÇA DO TERMOSTATO		1	1	
53706867	277637	JUNTA DO ABAFADOR	1	1	1	1
53706985	139123	JUNTA DO SUPORTE DE BALANCINS	6	6	6	6
53707090	139144	JUNTA DA TAMPA DE DISTRIBUIÇÃO		1	1	
53707165	139146	JUNTA DA DIANTEIRA DO VIRABREQUIM	1	1	1	1
53707265	139149	JUNTA DO TRASEIRO DO VIRABREQUIM	1	1	1	1
53707567	1675602	JUNTA DA TAMPA DE DISTRIBUIÇÃO	1	1	1	1
53708667	162142	JUNTA DA TAMPA DE FIXAÇÃO	1	1	1	1
53709490	2155242	JUNTA DO CARTER	1	1	1	1
53709770	238775	JUNTA DA TAMPA DA BOMBA DE ÓLEO	1	1	1	1
53710030		JUNTA DA TRAVA DO VOLANTE PEQUENO	3	3	3	3
53710130		JUNTA DA TRAVA DE BIELAS	1	1	1	1
53710630		JUNTA DA TRAVA DO VOLANTE	1	1	1	1
53710967	131236	JUNTA DA CARÇAÇA DA BOMBA DE ÁGUA	1	1	1	1
53714867	170765	JUNTA DO FILTRO ROTATIVO	1	1	1	1
53715067	232961	JUNTA DO FILTRO DE ÓLEO	1	1	1	1
53715117	131294	JUNTA DO COLETOR DE ESCAPAMENTO		2	2	
53715217	131295	JUNTA DO COLETOR DE ESCAPAMENTO		2	2	
53715367	235610	JUNTA DA VEDAÇÃO	1	1	1	1
53715467	238148	JUNTA DA TAMPA TERMOSTATO		1	1	
53715567	283403	JUNTA DO FILTRO ROTATIVO DE ÓLEO	1	1	1	1
53717467	238309	JUNTA DO ABAFADOR	1	1	1	1
53717667	272793	JUNTA DA TAMPA LATERAL DO CARTER	1			1
53723616	1109288	JUNTA DO COLETOR ESCAPAMENTO	2	2		2
53723716	378264	JUNTA DO COLETOR ESCAPAMENTO	2	2		2
53725105	373472	JUNTA DO CABEÇOTE	2	2	2	2
53725267	292759	JUNTA DO TUBO EANTRADA ÁGUA	1	1	1	1
53725790	1675584	JUNTA DO COLETOR ADMISSÃO	2			2
53725890	1675583	JUNTA DO COLETOR ADMISSÃO	4			4
53725967	295050	JUNTA DO TERMOSTATO	1			1
53726067		JUNTA DA VEDAÇÃO	2			2
53726167	371238	JUNTA DO COMPRESSOR	1	1	1	1
53726267	338332	JUNTA DO CONJUNTO DE ADMISSÃO	1			1
53726367	277633	JUNTA DA TAMPA LATERAL	1			1
53726467	287334	JUNTA DO TERMOSTATO	1			1
53726567	287559	JUNTA DO RESPIRO DO MOTOR	1			1
53726667		JUNTA DA VEDAÇÃO	1			1
53726767		JUNTA DA VEDAÇÃO	1	1	1	1
53729245		JUNTA DO ANÉL DE CAMISA	12			12
53754440	1302828	JUNTA DA CINTA DE CAMISA	6			6
83727526		KIT DE ARRUELAS SUPERIOR				
83727629		KIT DE ARRUELAS	1	1	1	1
83727741		KIT DE BORRACHAS	1	1	1	1
RE02069S		RETENTOR TRASEIRO	1	1		1
RE02235S		RETENTOR DIANTEIRO	1	1		1

• VENDE-SE AVULSO

DS11/DSC11 6 CILINDROS 11 LITROS (SÉRIE 3)

APLICAÇÃO

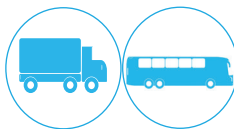

SCANIA DN11/DS11 6 CIL 11L(SERIE 2)

SCANIA CAMINHÃO 112H 1982/86 ; 112HS 1987/89 ; 112HW 1989/91

SCANIA ÔNIBUS S112/K112 1983/91

SCANIA DS11/DSC11 6 CIL 11L(SERIE 3)

SCANIA CAMINHÃO R113E/R113H 1991/98 ; T113E/T113H 1991/98

SCANIA ÔNIBUS S113 1991/93 ; L113 1993/98 ; K113 1994/98

DS11/DSC11 6 CILINDROS 11 LITROS (SÉRIE 3)

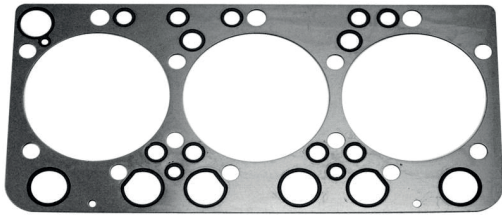

54725105

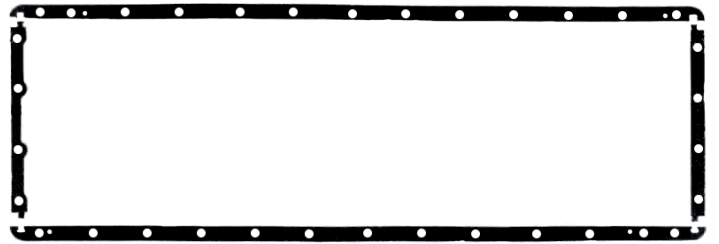

53709490

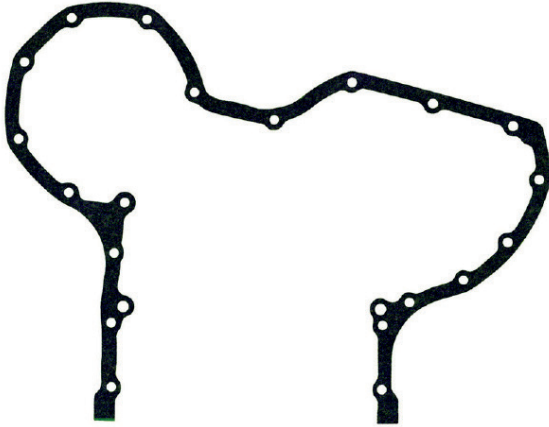

53707567

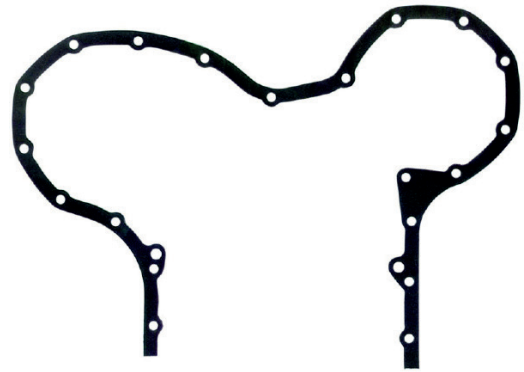

53707090

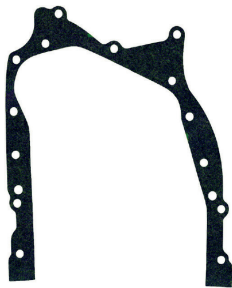

53705267



53706567

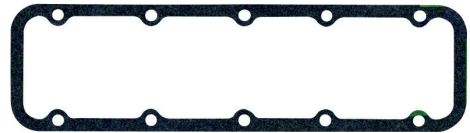

53704850

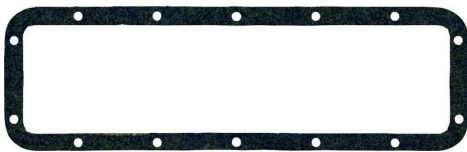

53705167

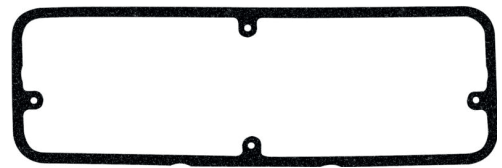

53704850



53715567



53705090



53710030



53710130



53710630



53725790

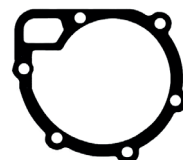

53710967

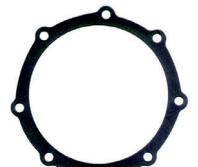

53708667



RE02235S



53707165



RE02069S

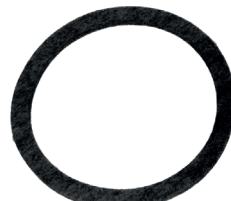

53707265

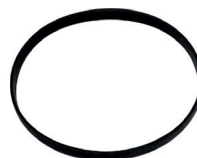

53754440

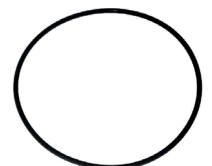

53729245

DS11/DSC11 6 CILINDROS 11 LITROS (SÉRIE 3)



83727741 KIT DE BORRACHAS			
Nº ABR	DESCRIÇÃO	QTD	
50028141	VEDADOR 106,7 X 3,5 MM	1	
50027941	VEDADOR 106,5 X 2,1 MM	1	
50005741	VEDADOR 20,0 X 4,0 MM	3	
50010941	VEDADOR 26,0 X 3,2 MM	2	
50009141	VEDADOR 59,0 X 3,4 MM	1	
50028841	VEDADOR 126,0 X 5,0 MM	1	
50029141	VEDADOR 135,0 X 2,8 MM	2	
50030741	VEDADOR 43,5,0 X 3,4 MM	2	
50031441	VEDADOR 53,0 X 3,3 MM	2	
50034241	VEDADOR 10,2 X 3,2 MM	1	
50035841	VEDADOR 41,5 X 56,3 X 3,5 MM	1	
50036941	VEDADOR 13,0 X 2,5 MM	2	
50039641	VEDADOR 16,0 X 2,4 MM	1	
50040541	VEDADOR 19,0 X 3,2 MM	3	
50054541	VEDADOR 34,5 X 46,0 X 2,5 MM	1	
50055141	VEDADOR 18,0 X 29,0 X 4,3 MM	4	
50026841	VEDADOR 74,2 X 3,5 MM	2	
53702441	VEDADOR TERMOSTATO	1	
53751041	VEDADOR TAMPA VÁLVULA	4	

83727629 KIT DE ARRUELAS			
Nº ABR	DESCRIÇÃO	QTD	
50011323	ARRUELA COBRE 8,3 X 13,8 X 1,0 MM	1	
50083330	ARRUELA AÇO 9,5 X 20,0 X 2,0 MM	6	
50021229	ARRUELA ALUMÍNIO 14,0 X 20,0 X 1,5 MM	10	
50018529	ARRUELA ALUMÍNIO 12,0 X 16,0 X 1,5 MM	8	
50012223	ARRUELA COBRE 8,0 X 12,0 X 1,0 MM	14	
50071228	ARRUELA ALUMÍNIO 26,4 X 33,7 X 1,0 MM	1	
50025829	ARRUELA ALUMÍNIO 18,0 X 24,0 X 1,0 MM	1	
50015528	ARRUELA ALUMÍNIO 10,0 X 16,0 X 1,0 MM	12	
	ARRUELA COBRE 10,2 X 21,3 X 1,8 MM	6	
50015429	ARRUELA ALUMÍNIO 10,0 X 14,0 X 1,5 MM	4	
50026728	ARRUELA ALUMÍNIO 20,0 X 26,0 X 1,0 MM	2	

83727526 KIT DE ARRUELA SUPERIOR			
Nº ABR	DESCRIÇÃO	QTD	
50014123	ARRUELA COBRE 9,5 X 20,0 X 1,0 MM	6	
50002129	ARRUELA ALUMÍNIO 14,0 X 20,0 X 1,5 MM	4	
50018529	ARRUELA ALUMÍNIO 12,0 X 16,0 X 1,5 MM	8	
50012223	ARRUELA COBRE 8,0 X 12,0 X 1,0 MM	14	

DN11/DS11/DSC11 6 CILINDROS 24 VÁLVULAS 11 LITROS UNIFICADO (SÉRIE 2 E 3)

Nº JOGO		DESCRIÇÃO		
73710430		JOGO DE JUNTAS COMPLETO DN11/DS11/DSC11 COM RETENORES COM ANÉIS DE CAMISA	1	
63710435		JOGO DE JUNTAS COMPLETO DN11/DS11/DSC11 SEM RETENORES SEM ANÉIS DE CAMISA	2	
Nº ABR	Nº ORIGINAL	DESCRIÇÃO		
53725105	373472	JUNTA DO CABEÇOTE Ø148MM	2	2
53704850	131103	JUNTA DA TAMPA DAS VÁLVULAS	2	2
53715117	131294	JUNTA DO COLETOR DE ESCAPAMENTO	2	2
53715217	131295	JUNTA DO COLETOR DE ESCAPAMENTO	2	2
53723616	1109288	JUNTA DO COLETOR DE ESCAPAMENTO	2	2
53723716	378264	JUNTA DO COLETOR DE ESCAPAMENTO	2	2
53725790	1675584	JUNTA DO COLETOR DE ADMISSÃO	2	2
53725890	1675583	JUNTA DO COLETOR DE ADMISSÃO	2	4
53705785	277632	JUNTA DO COLETOR DE ADMISSÃO	2	2
53709490	2155242	JUNTA DO CÂRTER	1	1
53707085	139144	JUNTA DA TAMPA FRONTAL DE DISTRIBUIÇÃO	1	1
53707598	1675602	JUNTA DA TAMPA FRONTAL DE DISTRIBUIÇÃO	1	1
53706567	287555	JUNTA DA CARÇAÇA DO VOLANTE	1	1
53705267	287554	JUNTA DA TAMPA TRASEIRA DE DISTRIBUIÇÃO	1	1
RE02069S		RETENTOR TRASEIRO DO VIRABREQUIM 130X160X15MM		1
RE02235S		RETENTOR DIANTEIRO DO VIRABREQUIM 80X100X12MM		1
52161231		JUNTA DO CARACOL DA TURBINA	1	1
53702867	35161	JUNTA DA TUBULAÇÃO DE ÁGUA	1	1
53702967	35309	JUNTA DO TUBO DO RESPIRO	1	1
53704990	131131	JUNTA DA FLANGE DO CABEÇOTE	1	1
53705090	131133	JUNTA DO TERMOSTATO	2	2
53705167	131166	JUNTA DA TAMPA LATERAL	2	2
53705667	139274	JUNTA DA CARÇAÇA DE DISTRIBUIÇÃO	1	1
53706667	139044	JUNTA DA TAMPA DO TERMOSTATO	1	1
53706867	277637	JUNTA DO ABAFADOR	1	1
53706985	139123	JUNTA DO SUPORTE DOS BALANCINS	6	6
53707165	139146	JUNTA DIANTEIRA DO VIRABREQUIM	1	1
53707265	139149	JUNTA TRASEIRO DO VIRABREQUIM	1	1
53707367	131305	JUNTA DO EIXO DA BOMBA INJETORA	1	1
53708231		JUNTA DO CARACOL DA TURBINA	1	1
53708667	162142	JUNTA DA FIXAÇÃO DE POLIA	1	1
53709770	238775	JUNTA DA TAMPA DA BOMBA DE ÓLEO	1	1
53710030	131043	TRAVA DO VOLANTE (MENOR)	3	3
53710130		TRAVA DAS BIELAS	1	1
53710630	139493	TRAVA DO VOLANTE (MAIOR)	1	1
53710967	131236	JUNTA DA CARÇAÇA DA BOMBA DE ÁGUA	1	1
53711331		JUNTA DA MESA DA TURBINA	1	1
53714767		JUNTA DA VEDAÇÃO	1	1
53714867	170765	JUNTA DO FILTRO ROTATIVO	1	1
53714967		JUNTA DA VEDAÇÃO	1	1
53715067	232961	JUNTA DO RADIADOR DE ÓLEO À CARÇAÇA DO ROTATIVO	1	1
53715367	235610	JUNTA DO TUBO DE RETORNO DO ÓLEO	1	1
53715467	238148	JUNTA DA TAMPA DO TERMOSTATO	1	1
53715567	283403	JUNTA DO FILTRO ROTATIVO DE ÓLEO	1	1
53715967		JUNTA DO TUBO DE RETORNO DO ÓLEO	1	1
53717467	238309	JUNTA DA BOMBA HIDRÁULICA	1	1
53717667	272793	JUNTA DA TAMPA DO MEDIADOR DE ÓLEO	1	1
53720496	142972	JUNTA DO COMPRESSOR	1	1
53720767		JUNTA DA ENTRADA DE ÓLEO DA TURBINA	1	1
53725267	292759	JUNTA DO TUBO E ENTRADA DE ÁGUA	1	1
53725967	295050	JUNTA DO TERMOSTATO	1	1
53726067	287559	JUNTA DO RESPIRO	2	2
53726167	271238	JUNTA DO TERMOSTATO	1	1
53726267	338332	JUNTA DO COLETOR DE ADMISSÃO	1	1
53726367	277633	JUNTA DA TAMPA LATERAL DO CABEÇOTE	1	1
53726467	287334	JUNTA DO TERMOSTATO	1	1
53726567	287559	JUNTA DO TUBO DO COLETOR DE ESCAPAMENTO	1	1
53726667		JUNTA DA VEDAÇÃO	1	1
53726767		JUNTA DA VEDAÇÃO	1	1
50029243		ANEL DE CAMISA		18
53754440	1302828	CINTA DA CAMISA		6
83727526		KIT DE ARRUELAS DO JOGO SUPERIOR		
83727629		KIT DE ARRUELAS	1	1
83727741		KIT DE BORRACHAS	1	1

● VENDE-SE AVULSO

DN11/DS11/DSC11 6 CILINDROS 24 VÁLVULAS 11 LITROS UNIFICADO (SÉRIE 2 E 3)

APLICAÇÃO

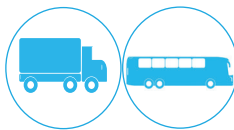

CAMINHÃO 112H 1982/86 ; 112HS 1987/89 ; 112HW 1989/91 ; R113E/R113H 1991/98 ; T113E/T113H 1991/98

ÔNIBUS S112/K112 1983/91 ; S113 1993/98 ; L113 1993/98 ; K113 1994/98 ;

DN11/DS11/DSC11 6 CILINDROS 24 VÁLVULAS 11 LITROS UNIFICADO (SÉRIE 2 E 3)

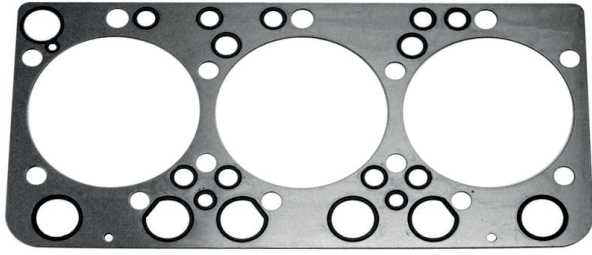

53725105

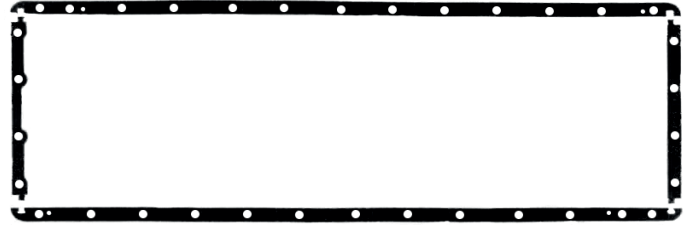

53709490

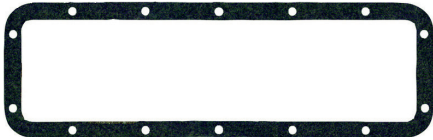

53705167

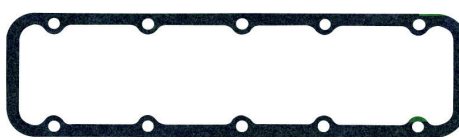

53705790



53704850

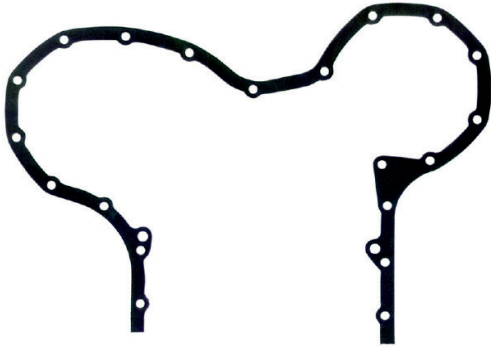

53707085

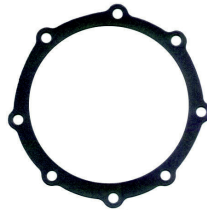

53708667

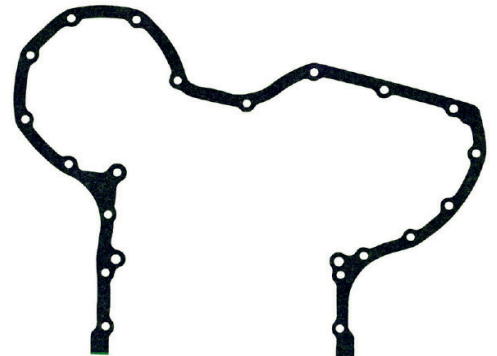

53707567

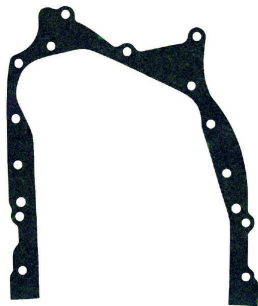

53705267

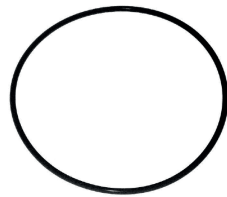

50029243

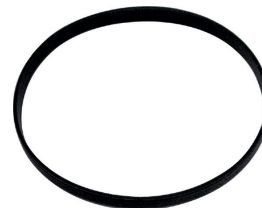

53754440



53706567



53704990



53723616



53725890



53725790



53715117



53715217



53725967



53705090

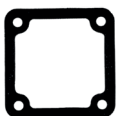

53717667



53726467



53714867



53726267



53715067



53706867



53717467



53726367

DN11/DS11/DSC11 6 CILINDROS 24 VÁLVULAS 11 LITROS UNIFICADO (SÉRIE 2 E 3)

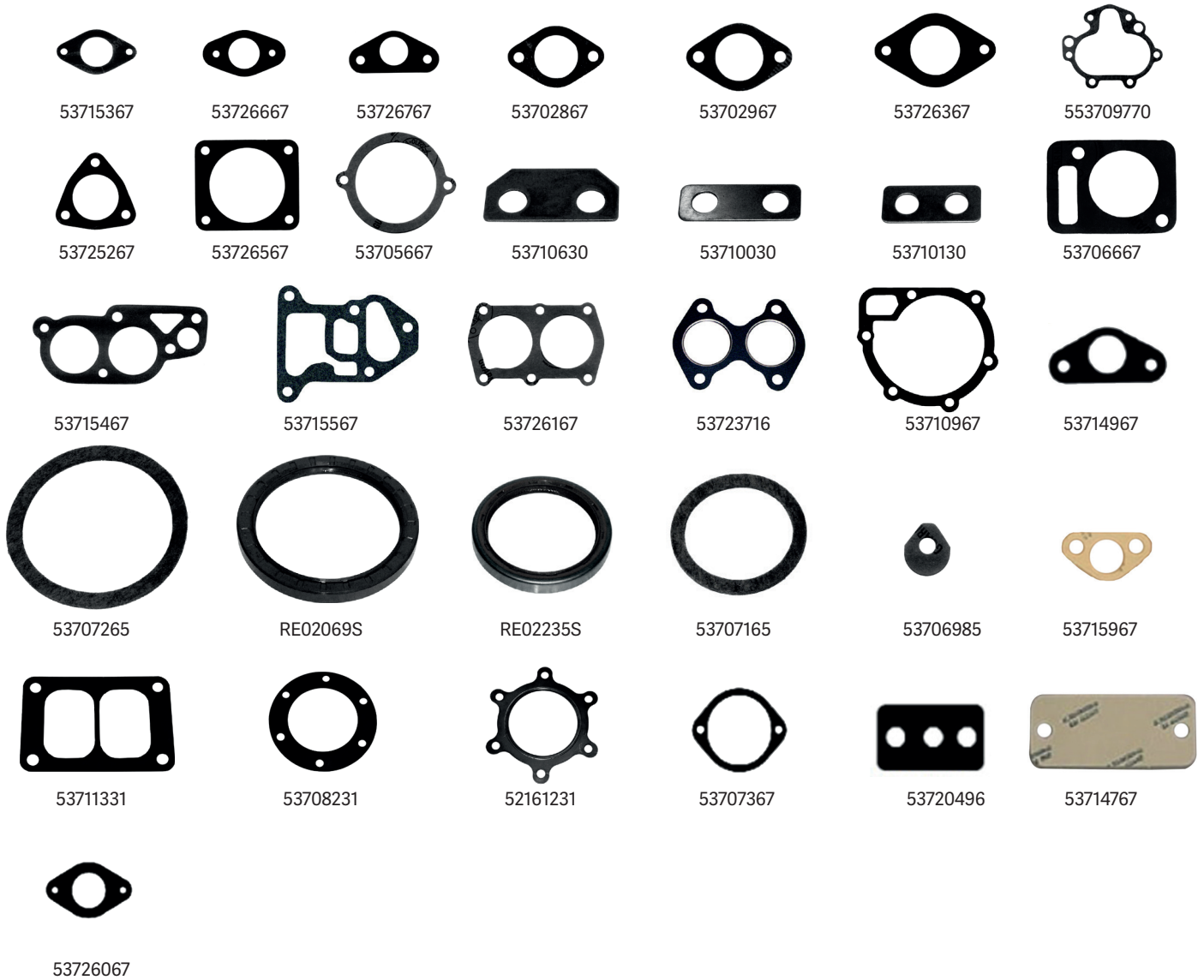

83727741		KIT DE BORRACHA	
Nº ABR	DESCRIÇÃO		QTD
50028141	VEDADOR 106,7 X 3,5 MM		1
50027941	VEDADOR 106,5 X 2,1 MM		1
50005741	VEDADOR 20,0 X 4,0 MM		3
50010941	VEDADOR 26,0 X 3,2 MM		2
50009141	VEDADOR 59,0 X 3,4 MM		1
50028841	VEDADOR 126,0 X 5,0 MM		1
50029141	VEDADOR 135,0 X 2,8 MM		2
50030741	VEDADOR 43,5 X 3,4 MM		2
50031441	VEDADOR 53,0 X 3,3 MM		2
50034241	VEDADOR 10,2 X 3,2 MM		1
50035841	VEDADOR 41,5 X 56,3 X 3,5 MM		1
50036941	VEDADOR 13,0 X 2,5 MM		2
50039641	VEDADOR 16,0 X 2,4 MM		1
50040541	VEDADOR 19,0 X 3,2 MM		3
50054541	VEDADOR 34,5 X 46,0 X 2,5 MM		1
50055141	VEDADOR 18,0 X 29,0 X 4,3 MM		4
50026841	VEDADOR 74,2 X 3,5 MM		2
53702441	VEDADOR TERMOSTATO		1
53751041	VEDADOR TAMPA VÁLVULA		4

83727629		KIT DE ARRUELAS	
Nº ABR	DESCRIÇÃO		QTD
50011323	ARRUELA COBRE 8,3 X 13,8 X 1,0 MM		1
50014120	ARRUELA AÇO 9,5 X 20,0 X 2,0 MM		6
50021229	ARRUELA ALUMÍNIO 14,0 X 20,0 X 1,5 MM		10
50018529	ARRUELA ALUMÍNIO 12,0 X 16,0 X 1,5 MM		8
50011223	ARRUELA COBRE 8,0 X 12,0 X 1,0 MM		14
50071228	ARRUELA ALUMÍNIO 26,4 X 33,7 X 1,0 MM		1
50025829	ARRUELA ALUMÍNIO 18,5 X 23,9 X 1,5 MM		1
50015528	ARRUELA ALUMÍNIO 10,0 X 16,0 X 1,0 MM		12
	ARRUELA COBRE 10,2 X 21,3 X 1,8 MM		6
50015429	ARRUELA ALUMÍNIO 10,0 X 14,0 X 1,5 MM		4
50026728	ARRUELA ALUMÍNIO 20,0 X 26,0 X 1,0 MM		2

83727526		KIT DE ARRUELA DO JOGO SUPERIOR	
Nº ABR	DESCRIÇÃO		QTD
50014120	ARRUELA DE COBRE 9,5 x 20,0 x 2,0 MM		6
50021229	ARRUELA DE ALUMÍNIO 14,0 x 20,0 x 1,5 MM		4
50018529	ARRUELA DE ALUMÍNIO 12,0 x 16,0 x 1,5 MM		8
50012223	ARRUELA DE COBRE 8,0 x 12,0 x 1,0 MM		14

DN11/DS11/DSC11 6 CILINDROS 24 VÁLVULAS 11 LITROS UNIFICADO (SÉRIE 2 E 3)

Nº JOGO		DESCRIÇÃO		
73710435		JOGO DE JUNTAS COMPLETO DN11/DS11/DSC11 COM RETENTORES SEM ANÉIS DE CAMISA	1	
63730435		JOGO DE JUNTAS SUPERIOR DN11/DS11/DSC11 SEM RETENTORES SEM ANÉIS DE CAMISA	2	
Nº ABR	Nº ORIGINAL	DESCRIÇÃO		
53725105	373472	JUNTA DO CABEÇOTE Ø148MM	2	2
53704850	131103	JUNTA DA TAMPA DAS VÁLVULAS	2	2
53715117	131294	JUNTA DO COLETOR DE ESCAPAMENTO	2	2
53715217	131295	JUNTA DO COLETOR DE ESCAPAMENTO	2	2
53723616	1109288	JUNTA DO COLETOR DE ESCAPAMENTO	2	2
53723716	378264	JUNTA DO COLETOR DE ESCAPAMENTO	2	2
53725790	1675584	JUNTA DO COLETOR DE ADMISSÃO	2	2
53725890	1675583	JUNTA DO COLETOR DE ADMISSÃO	2	4
53705785	277632	JUNTA DO COLETOR DE ADMISSÃO	2	2
53709490	2155242	JUNTA DO CÂRTER		1
53707085	139144	JUNTA DA TAMPA FRONTAL DE DISTRIBUIÇÃO		1
53707598	1675602	JUNTA DA TAMPA FRONTAL DE DISTRIBUIÇÃO		1
53706567	287555	JUNTA DA CARÇAÇA DO VOLANTE		1
53705267	287554	JUNTA DA TAMPA TRASEIRA DE DISTRIBUIÇÃO	1	1
RE02069S		RETENTOR TRASEIRO DO VIRABREQUIM 130X160X15MM		1
RE02235S		RETENTOR DIANTEIRO DO VIRABREQUIM 80X100X12MM		1
52161231		JUNTA DO CARACOL DA TURBINA		1
53702867	35161	JUNTA DA TUBULAÇÃO DE ÁGUA	1	1
53702967	35309	JUNTA DO TUBO DO RESPIRO	1	1
53704990	131131	JUNTA DA FLANGE DO CABEÇOTE	1	1
53705090	131133	JUNTA DO TERMOSTATO	2	2
53705167	131166	JUNTA DA TAMPA LATERAL	2	2
53705667	139274	JUNTA DA CARÇAÇA DE DISTRIBUIÇÃO		1
53706667	139044	JUNTA DA TAMPA DO TERMOSTATO	1	1
53706867	277637	JUNTA DO ABAFADOR	1	1
53706985	139123	JUNTA DO SUPORTE DOS BALANCINS	6	6
53707165	139146	JUNTA DIANTEIRA DO VIRABREQUIM		1
53707265	139149	JUNTA TRASEIRO DO VIRABREQUIM		1
53707367	131305	JUNTA DO EIXO DA BOMBA INJETORA	1	1
53708231		JUNTA DO CARACOL DA TURBINA		1
53708667	162142	JUNTA DA FIXAÇÃO DE POLIA	1	1
53709770	238775	JUNTA DA TAMPA DA BOMBA DE ÓLEO		1
53710030	131043	TRAVA DO VOLANTE (MENOR)		3
53710130		TRAVA DAS BIELAS		1
53710630	139493	TRAVA DO VOLANTE (MAIOR)		1
53710967	131236	JUNTA DA CARÇAÇA DA BOMBA DE ÁGUA	1	1
53711331		JUNTA DA MESA DA TURBINA		1
53714767		JUNTA DA VEDAÇÃO	1	1
53714867	170765	JUNTA DO FILTRO ROTATIVO	1	1
53714967		JUNTA DA VEDAÇÃO	1	1
53715067	232961	JUNTA DO RADIADOR DE ÓLEO À CARÇAÇA DO ROTATIVO	1	1
53715367	235610	JUNTA DO TUBO DE RETORNO DO ÓLEO	1	1
53715467	238148	JUNTA DA TAMPA DO TERMOSTATO		1
53715567	283403	JUNTA DO FILTRO ROTATIVO DE ÓLEO	1	1
53715967		JUNTA DO TUBO DE RETORNO DO ÓLEO		1
53717467	238309	JUNTA DA BOMBA HIDRÁULICA	1	1
53717667	272793	JUNTA DA TAMPA DO MEDIADOR DE ÓLEO	1	1
53720496	142972	JUNTA DO COMPRESSOR	1	1
53720767		JUNTA DA ENTRADA DE ÓLEO DA TURBINA		1
53725267	292759	JUNTA DO TUBO E ENTRADA DE ÁGUA	1	1
53725967	295050	JUNTA DO TERMOSTATO	1	1
53726067	287559	JUNTA DO RESPIRO	2	2
53726167	271238	JUNTA DO TERMOSTATO	1	1
53726267	338332	JUNTA DO COLETOR DE ADMISSÃO	1	1
53726367	277633	JUNTA DA TAMPA LATERAL DO CABEÇOTE	1	1
53726467	287334	JUNTA DO TERMOSTATO	1	1
53726567	287559	JUNTA DO TUBO DO COLETOR DE ESCAPAMENTO	1	1
53726667		JUNTA DA VEDAÇÃO	1	1
53726767		JUNTA DA VEDAÇÃO	1	1
50029243		ANEL DE CAMISA		
53754440	1302828	CINTA DA CAMISA		
83727526		KIT DE ARRUELAS DO JOGO SUPERIOR	1	
83727629		KIT DE ARRUELAS		1
83727741		KIT DE BORRACHAS		1

● VENDE-SE AVULSO

DN11/DS11/DSC11 6 CILINDROS 24 VÁLVULAS 11 LITROS UNIFICADO (SÉRIE 2 E 3)

APLICAÇÃO

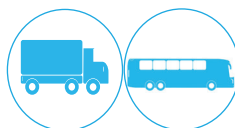

CAMINHÃO 112H 1982/86 ; 112HS 1987/89 ; 112HW 1989/91 ; R113E/R113H 1991/98 ; T113E/T113H 1991/98

ÔNIBUS S112/K112 1983/91 ; S113 1993/98 ; L113 1993/98 ; K113 1994/98 ;

DN11/DS11/DSC11 6 CILINDROS 24 VÁLVULAS 11 LITROS UNIFICADO (SÉRIE 2 E 3)

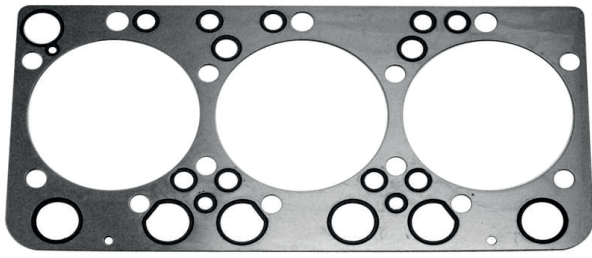

53725105

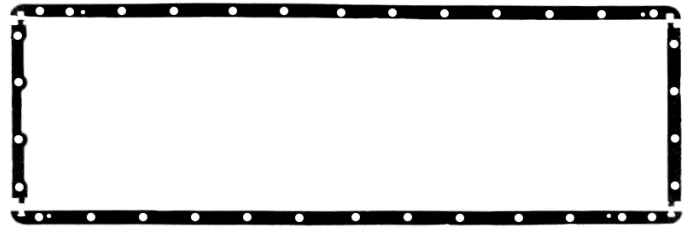

53709490

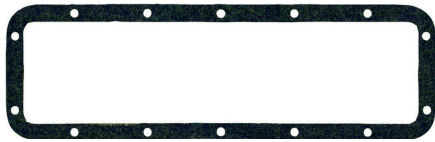

53705167

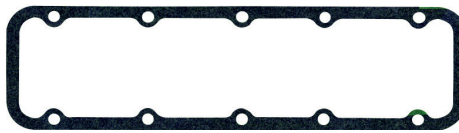

53705790



53704850

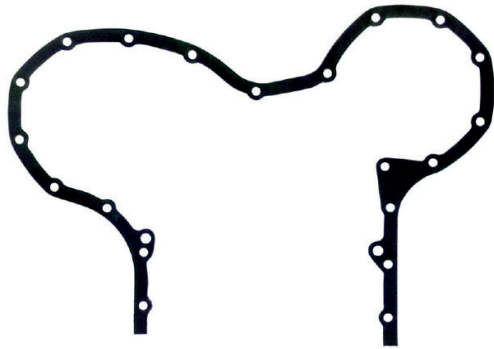

53707085

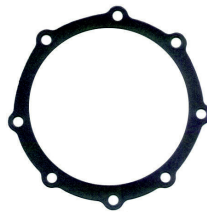

53708667

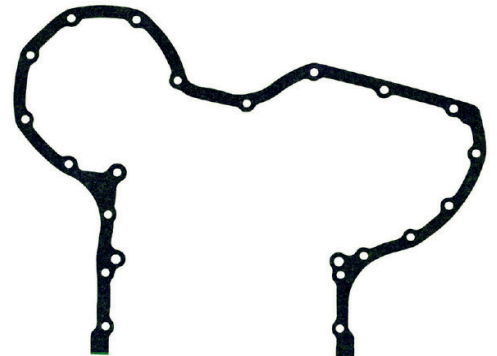

53707567

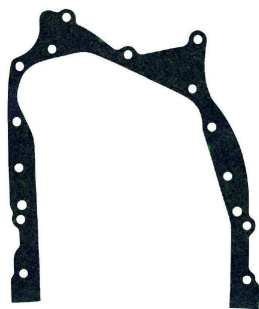

53705267

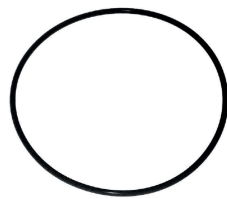

50029243

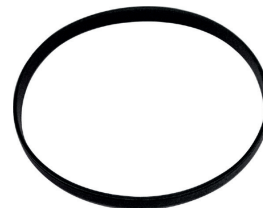

53754440

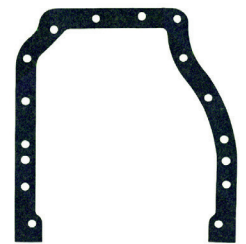

53706567



53704990



53723616



53725890



53725790



53715117



53715217



53725967



53705090

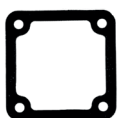

53717667



53726467



53714867



53726267



53715067



53706867



53717467



53726367

DN11/DS11/DSC11 6 CILINDROS 24 VÁLVULAS 11 LITROS UNIFICADO (SÉRIE 2 E 3)

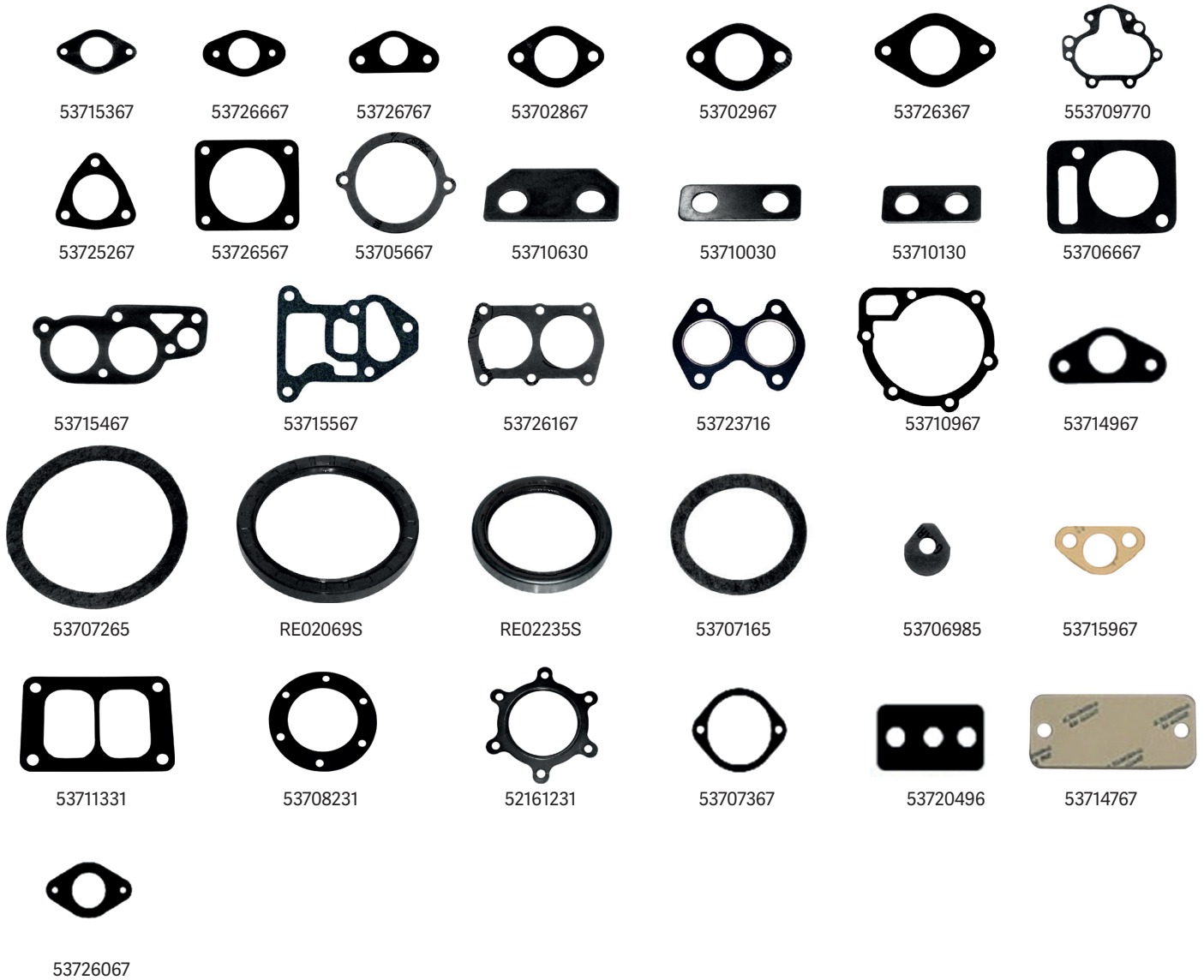

83727741		KIT DE BORRACHA	
Nº ABR	DESCRIÇÃO		QTD
50028141	VEDADOR 106,7 X 3,5 MM		1
50027941	VEDADOR 106,5 X 2,1 MM		1
50005741	VEDADOR 20,0 X 4,0 MM		3
50010941	VEDADOR 26,0 X 3,2 MM		2
50009141	VEDADOR 59,0 X 3,4 MM		1
50028841	VEDADOR 126,0 X 5,0 MM		1
50029141	VEDADOR 135,0 X 2,8 MM		2
50030741	VEDADOR 43,5,0 X 3,4 MM		2
50031441	VEDADOR 53,0 X 3,3 MM		2
50034241	VEDADOR 10,2 X 3,2 MM		1
50035841	VEDADOR 41,5 X 56,3 X 3,5 MM		1
50036941	VEDADOR 13,0 X 2,5 MM		2
50039641	VEDADOR 16,0 X 2,4 MM		1
50040541	VEDADOR 19,0 X 3,2 MM		3
50054541	VEDADOR 34,5 X 46,0 X 2,5 MM		1
50055141	VEDADOR 18,0 X 29,0 X 4,3 MM		4
50026841	VEDADOR 74,2 X 3,5 MM		2
53702441	VEDADOR TERMOSTATO		1
53751041	VEDADOR TAMPA VÁLVULA		4

83727629		KIT DE ARRUELAS	
Nº ABR	DESCRIÇÃO		QTD
50011323	ARRUELA COBRE 8,3 X 13,8 X 1,0 MM		1
50014120	ARRUELA AÇO 9,5 X 20,0 X 2,0 MM		6
50021229	ARRUELA ALUMÍNIO 14,0 X 20,0 X 1,5 MM		10
50018529	ARRUELA ALUMÍNIO 12,0 X 16,0 X 1,5 MM		8
50011223	ARRUELA COBRE 8,0 X 12,0 X 1,0 MM		14
50071228	ARRUELA ALUMÍNIO 26,4 X 33,7 X 1,0 MM		1
50025829	ARRUELA ALUMÍNIO 18,5 X 23,9 X 1,5 MM		1
50015528	ARRUELA ALUMÍNIO 10,0 X 16,0 X 1,0 MM		12
	ARRUELA COBRE 10,2 X 21,3 X 1,8 MM		6
50015429	ARRUELA ALUMÍNIO 10,0 X 14,0 X 1,5 MM		4
50026728	ARRUELA ALUMÍNIO 20,0 X 26,0 X 1,0 MM		2

83727526		KIT DE ARRUELA DO JOGO SUPERIOR	
Nº ABR	DESCRIÇÃO		QTD
50014120	ARRUELA DE COBRE 9,5 x 20,0 x 2,0 MM		6
50021229	ARRUELA DE ALUMÍNIO 14,0 x 20,0 x 1,5 MM		4
50018529	ARRUELA DE ALUMÍNIO 12,0 x 16,0 x 1,5 MM		8
50012223	ARRUELA DE COBRE 8,0 x 12,0 x 1,0 MM		14

DC11/DSC12 6 CILINDROS 24 VÁLVUVAS 11,7 LITROS (SÉRIE 4)

Nº JOGO		DESCRIÇÃO						
63710129		JOGO JUNTA COMPLETO DC11 SEM RETENTORES COM ANÉIS DE CAMISA	1					
73710129		JOGO JUNTA COMPLETO DC11 COM RETENTORES COM ANÉIS DE CAMISA	2					
63710429		JOGO JUNTA COMPLETO DSC12 SEM RETENTORES COM ANÉIS DE CAMISA	3					
73710429		JOGO JUNTA COMPLETO DSC12 COM RETENTORES COM ANÉIS DE CAMISA	4					
63710109		JOGO JUNTA COMPLETO DSC12 SEM RETENTORES COM ANÉIS DE CAMISA	5					
73710109		JOGO JUNTA COMPLETO DSC12 COM RETENTORES COM ANÉIS DE CAMISA	6					
Nº ABR	Nº ORIGINAL	DESCRIÇÃO						
50014049		JUNTA DA DIANTEIRO VIRABREQUIM	1	1	1			
50014149		JUNTA DA TRASEIRO VIRABREQUIM	1	1	1			
RE09282F		RETENTOR DA HASTE VÁLVUVAS	1	1	1			
53726805	1468555	JUNTA DO CABEÇOTE	6	6				
53751167	1374342	JUNTA DO TUBO ADMISSÃO	1	1	1	1	1	1
53751267	1374346	JUNTA DA BOMBA HIDRÁULICA	1	1	1	1	1	1
53751367	1374334	JUNTA DA TAMPA DE DISTRIBUIÇÃO			1	1	1	1
53751467	1374344	JUNTA DA BOMBA DE ÁGUA	1	1	1	1	1	1
53751567	1374336	JUNTA DA TUBULAÇÃO DE MANGUEIRAS	1	1	1	1	1	1
53751667	1375992	JUNTA DO CANO DE ÓLEO	1	1	1	1	1	1
53751867	1374517	JUNTA DO FILTRO DE ÁGUA	1	1	1	1	1	1
53753331	1374340	JUNTA DO COLETOR DE ADMISSÃO			6	6	6	6
53752147	1309051	JUNTA DO COLETOR DE ESCAPE	6	6	6	6	6	6
53752267	1375387	JUNTA DA CAIXA DE DISTRIBUIÇÃO	1	1	1	1	1	1
53752367	1374346	JUNTA DA BOMBA HIDRAULICA	1	1	1	1	1	1
53752467	1375383	JUNTA DA TAMPA LATERAL	3	3	3	3	3	3
53752667	1374327	JUNTA DA CAIXA DE DISTRIBUIÇÃO	1	1	1	1	1	1
53752767	1374330	JUNTA DO BOCAL DA VARETA DO ÓLEO	1	1	1	1	1	1
53752867	1391726	JUNTA DO RADIADOR DA VARETA	1	1	1	1	1	1
53752967	1374326	JUNTA DA TAMPA LATERAL	3	3	3	3	3	3
53753067	1460359	JUNTA DO CARTER	1	1	1	1	1	1
53753167	1374333	JUNTA DA CARÇAÇA DO TERMOSTATO	1	1	1	1	1	1
53754540	1445514	JUNTA DA TAMPA LATERAL	1	1				
53754640	1433886	JUNTA DO RADIADOR DE ÓLEO	1	1				
53754705	1377039	JUNTA DE CABEÇOTE			6	6	6	6
53754867	1403129	JUNTA DA TAMPA DE DISTRIBUIÇÃO	1	1				
82160177		KIT DA TURBINA	1	1	1	1	1	1
83728640		KIT DE TAMPA DE VÁLVUVAS					1	1
83728740		KIT DE TAMPA DE VÁLVUVAS	1	1	1	1		
83728940		KIT DE BORRACHAS	1	1	1	1	1	1
83729029		KIT DE ARRUELAS	1	1	1	1	1	1
83728840		KIT DE BORRACHAS			1	1	1	1
83729340		KIT DE BORRACHAS	1	1				

• VENDE-SE AVULSO

DC11/DSC12 6 CILINDROS 24 VÁLVUVAS 11,7 LITROS (SÉRIE 4)

APLICAÇÃO

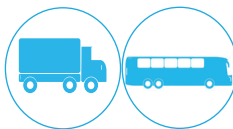

SCANIA DC11 6 CIL 24V 10.60L SERIE 4 MECANICO(EURO 3)

SCANIA CAMINHÃO P114 1998/02 ; P124 1998/00 ; T124 1998/01 ; R114 1998/01 ; T114 1998/01

SCANIA DSC12 6 CIL 24V 11.70L SERIE 4 MECANICO(EURO 3)

SCANIA CAMINHÃO R114 1999/99 ; R124 1998/01 ; T124 1998/01

SCANIA ÔNIBUS K124 1999/01

SCANIA DSC12 6 CIL 24V 11.70L SERIE 4 ELETRONICO(EURO 3)

SCANIA CAMINHÃO P114/R114/T114 2002/07 ; P124/R124/T124 2002/07

SCANIA ÔNIBUS K124 2002/07

DC11/DSC12 6 CILINDROS 24 VÁLVUVAS 11,7 LITROS (SÉRIE 4)



53754705

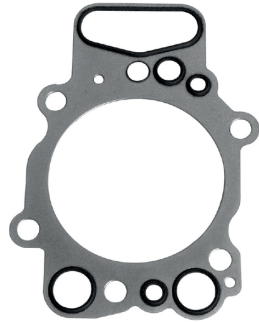

53726805

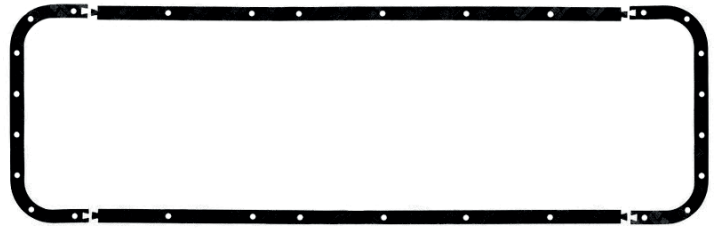

53753067

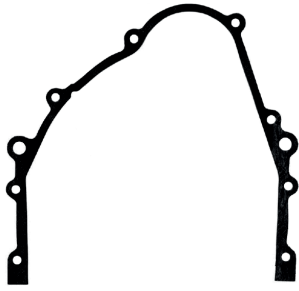

53751367

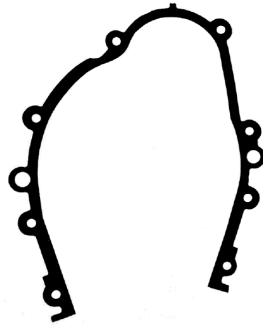

53754867



53752367

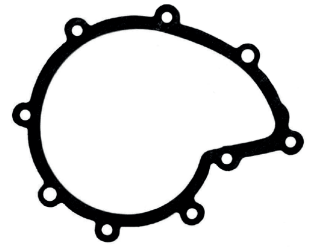

53751467

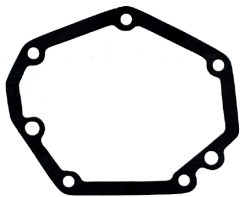

53752367

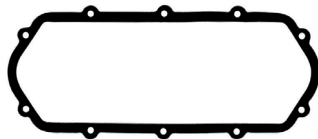

53752467

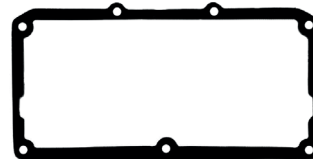

53752967

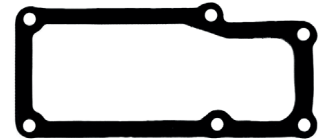

53753167



53751867



53752867

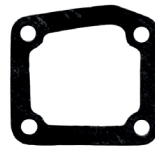

53752767



53752267



53752147



53751667



53751167

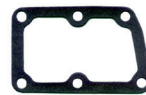

53751267



53753331



53753230

83728640

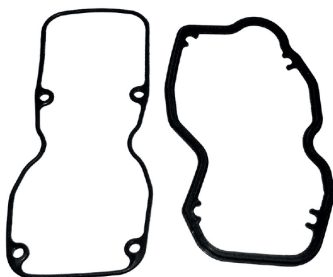

83728740

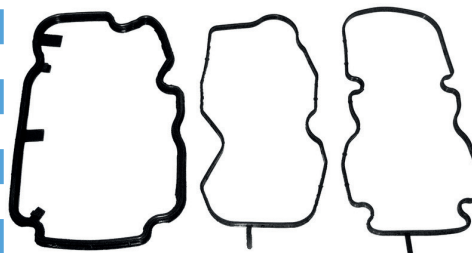

82160177



DC11/DSC12 6 CILINDROS 24 VÁLVUVAS 11,7 LITROS (SÉRIE 4)

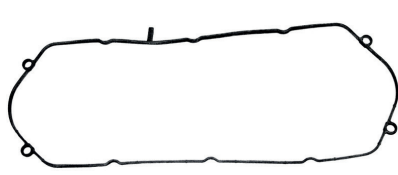
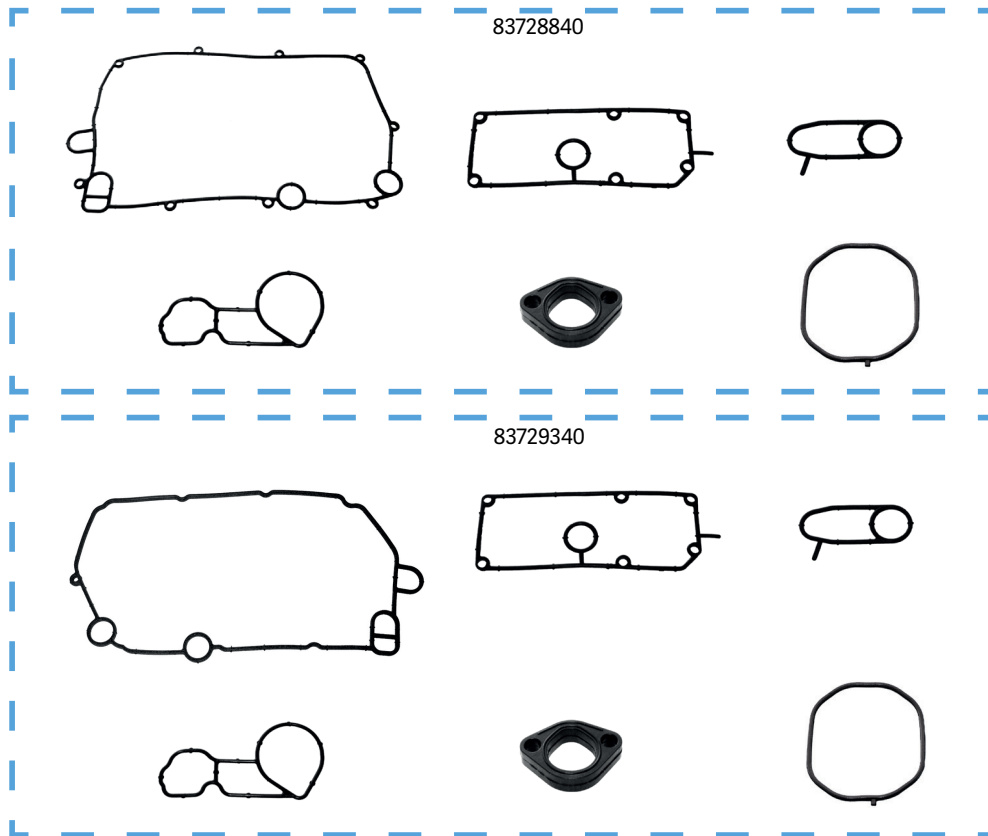

53754540

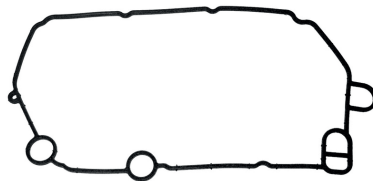

53754640



50014149



50014049



53751567



RE09282F

83728940		KIT DE BARRACHA	
Nº ABR	DESCRIÇÃO	QTD	
50028141	VEDADOR 106,7 X 3,5 MM	1	
50027941	VEDADOR 106,5 X 2,1 MM	1	
50005741	VEDADOR 20,0 X 4,0 MM	3	
50010941	VEDADOR 26,0 X 3,2 MM	2	
50009141	VEDADOR 59,0 X 3,4 MM	1	
50028841	VEDADOR 126,0 X 5,0 MM	1	
50029141	VEDADOR 135,0 X 2,8 MM	2	
50030741	VEDADOR 43,5,0 X 3,4 MM	2	
50031441	VEDADOR 53,0 X 3,3 MM	2	
50034241	VEDADOR 10,2 X 3,2 MM	1	
50035841	VEDADOR 41,5 X 56,3 X 3,5 MM	1	
50036941	VEDADOR 13,0 X 2,5 MM	2	
50039641	VEDADOR 16,0 X 2,4 MM	1	
50040541	VEDADOR 19,0 X 3,2 MM	3	
50054541	VEDADOR 34,5 X 46,0 X 2,5 MM	1	
50055141	VEDADOR 18,0 X 29,0 X 4,3 MM	4	
50026841	VEDADOR 74,2 X 3,5 MM	2	
53702441	VEDADOR TERMOSTATO	1	
53751041	VEDADOR TAMPA VÁLVULA	4	

83729029		KIT DE ARRUELA	
Nº ABR	DESCRIÇÃO	QTD	
56114120	ARRUELA CU 9,5 x 20,0 x 2,0 mm	6	
50021228	ARRUELA AL 14,0 x 20,0 x 1,0 mm	20	
50018529	ARRUELA AL 12,0 x 16,0 x 1,5 mm	8	
50011228	ARRUELA AL 8,0 x 12,0 x 1,0 mm	18	
50029827	ARRUELA AL 24,0 x 38,0 x 1,0 mm	1	
50072429	ARRUELA AL 22,5 x 26,7 x 1,5 mm	2	
50023329	ARRUELA AL 16,0 x 22,0 x 1,5 mm	6	
50023629	ARRUELA AL 16,3 x 19,8 x 1,5 mm	8	
50015428	ARRUELA AL 10,0 x 14,0 x 1,0 mm	4	

DC11/DSC12 8 CILINDROS 24 VÁLVULAS 11,7 LITROS (EURO 3)

Nº JOGO		DESCRIÇÃO							
63730121	JOGO DE JUNTA MONOCILÍNDRICO DC11 SEM RETENTORES SEM ANÉIS DE CAMISA								1
73730121	JOGO DE JUNTA MONOCILÍNDRICO DC11 COM RETENTORES SEM ANÉIS DE CAMISA								2
63730421	JOGO DE JUNTA MONOCILÍNDRICO DSC12 SEM RETENTORES SEM ANÉIS DE CAMISA								3
73730421	JOGO DE JUNTA MONOCILÍNDRICO DSC12 COM RETENTORES SEM ANÉIS DE CAMISA								4
63730101	JOGO DE JUNTA MONOCILÍNDRICO DSC12 SEM RETENTORES SEM ANÉIS DE CAMISA								5
73730101	JOGO DE JUNTA MONOCILÍNDRICO DSC12 COM RETENTORES SEM ANÉIS DE CAMISA								6
Nº ABR	Nº ORIGINAL	DESCRIÇÃO							
53726805	1468555	JUNTA DO CABEÇOTE		1	1				
53754705	1377039	JUNTA DO CABEÇOTE				1	1	1	1
53753331	1374340	JUNTA DO COLETOR DE ADMISSÃO				1	1	1	1
53753331	1309051	JUNTA DO COLETOR DO ESCAPE		1	1	1	1	1	1
RE09282F		RETENTOR DA HÁSTE DE VÁLVULA		4	4	4	4	4	4
53753230	1374842	ARRUELA 9,3X13X1X1,00 MM		6	6	6	6	6	6
53755340	1340615	VEDAÇÃO DO TUBO INJETOR		4	4	4	4	4	4
53755340	1368061	VEDAÇÃO DO COLETOR DE COMBUSTÍVEL		1	1	1	1	1	1
50014120		ARRUELA DO BICO INJETOR		1	1	1	1	1	1
83728640		JOGO DE TAMPAS DE VÁLVULAS							1
83728740		JOGO DE TAMPAS DE VÁLVULAS		1	1	1	1		1

• VENDE-SE AVULSO

DC11/DSC12 8 CILINDROS 24 VÁLVUVAS 11,7 LITROS (EURO 3)



53754705

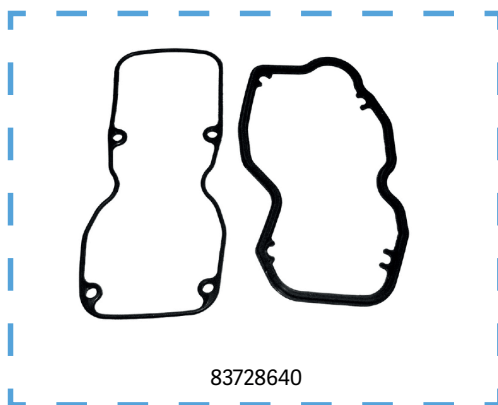

83728640

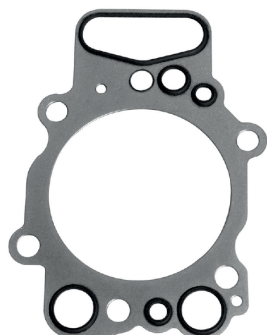

53726805

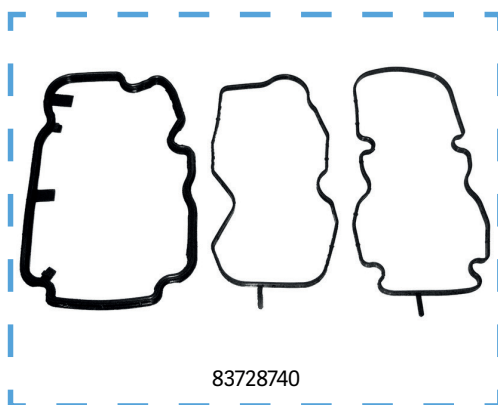

83728740



53752147

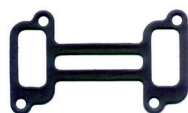

53753331



53753230



53755240



53755340



50014120



RE09282F

DS14 - LK140 / LK141 8 CILINDROS 1974

Nº JOGO		DESCRIÇÃO	
73712535		JOGO DE JUNTAS COMPLETO DS14/LK141 COM RETENTORES SEM ANÉIS DE CAMISA	1
63732535		JOGO DE JUNTAS MONOCILÍNDRICO DS14/LK140/LK141 SEM RETENTORES SEM ANÉIS DE CAMISA	2
Nº ABR	Nº ORIGINAL	DESCRIÇÃO	
53711405	170274	JUNTA DO CABEÇOTE	1 8
53718898	170702	JUNTA DA TAMPA LATERAL DAS VÁLVULAS	1
53718416	170907	JUNTA DO COLETOR DE ESCAPE	1
53713616	170363	JUNTA DO COLETOR DE ESCAPAMENTO	1 8
53718996	170700	JUNTA DO CÂRTER (SECCIONADA)	1
RE02069S	2069	RETENTOR TRASEIRO DO VIRABREQUIM 130,0 X 160,0 X 15,0 MM	1
RE02235S	2235	RETENTOR DIANTEIRO DO VIRABREQUIM 80,0 X 100,0 X 12,0 MM	1
RE00266N	266	RETENTOR DO EIXO DE ACIONAMENTO DA BOMBA INJETORA	1
53707165	139146	JUNTA DIANTEIRA DO VIRABREQUIM	1
53707265	139149	JUNTA TRASEIRA DO VIRABREQUIM	1
53710030	131043	TRAVA DO VOLANTE DO MOTOR - PEQUENA	3
53710341	170610	VEDADOR DA TAMPA DAS VÁLVULAS	1 8
53710530	131438	TRAVA DO SUPORTE DA ENGRENAGEM DA DISTRIBUIÇÃO	2
53710630	139493	TRAVA DO VOLANTE DO MOTOR - GRANDE	1
53713767	170372	JUNTA DA TAMPA TRASEIRA DA DISTRIBUIÇÃO	1
53716285	170696	JUNTA DO SUPORTE DIANTEIRO DO BLOCO	4
53716385	170686	JUNTA SUPORTE DA BOMBA DE ÁGUA	1
53716467	170966	JUNTA DO TUBO DE VENTILAÇÃO	1
53716590	170368	JUNTA DO CONDUTOR DE ÁGUA	1 8
53716680	277607	JUNTA DO COLETOR DE ADMISSÃO ESQUERDA / DIREITA	1 8
53716780	170675	JUNTA DO SUPORTE DO MANCAL DOS BALANCINS	2 16
53716867	170916	JUNTA DA CARÇA DA DISTRIBUIÇÃO	1
53716990		JUNTA	1
53717067	170937	JUNTA DO TUBO DE ENTRADA DO ÓLEO	1
53717190	170804	JUNTA DO TUBO DO SISTEMA DE LUBRIFICAÇÃO	1
53717290	170366	JUNTA DO TUBO DE ADMISSÃO ESQUERDO	1
53717390	170687	FIXAÇÃO DA CARÇA DA BOMBA DE ÁGUA - PEQUENA	1 1
53717467	332598	JUNTA DA BOMBA HIDRÁULICA	1
53717567	252804	JUNTA DA VÁLVULA TERMOSTÁTICA	3
53717667	272793	JUNTA DO MEDIDOR DO NÍVEL DO ÓLEO	1
53717767	170765	CARÇA DO FILTRO ROTATIVO	1
53717867	247990	JUNTA DO FILTRO DO ÓLEO	1
53717990	170706	JUNTA DA CARÇA DA DISTRIBUIÇÃO	1
53718090	170627	JUNTA DA TAMPA LATERAL DO CABEÇOTE	1 8
53718190	287559	JUNTA DO TUBO DE ADMISSÃO	1
53718316	170932	JUNTA DO TUBO DE SAÍDA DO ESCAPE - 3 FUROS	2
53718590	170694	JUNTA LATERAL DO MOTOR	2
53718667	170738	JUNTA DA TAMPA DA BOMBA DE ÁGUA	1
53718767	170705	JUNTA DA CARÇA DO VOLANTE	1
83727829		KIT DE ARRUELAS	1 1
83727941		KIT DE BORRACHAS	1

• VENDE-SE AVULSO

APLICAÇÃO



SCANIA CAMINHÃO LK140 1975/80 ; LK141 1981/89 ; R142M/R142H/T142M/T142H 1982/86 ; R142HS/R142HW 1987/91 ; T142HS/142HW 1987/91

DS14 - LK140 / LK141 8 CILINDROS 1974

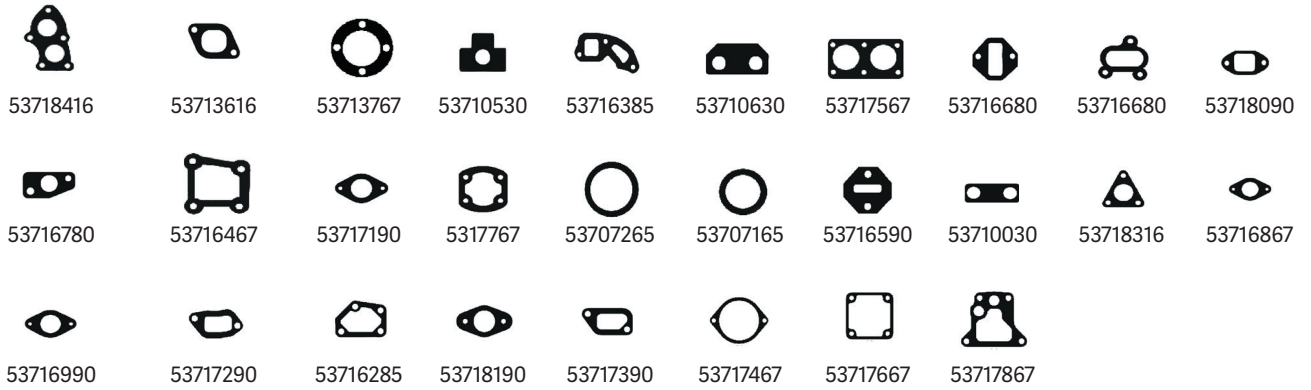
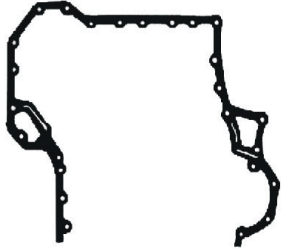
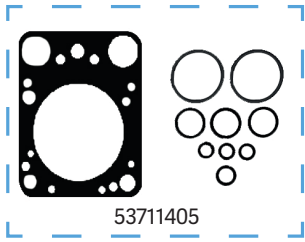

83727941 KIT DE BORRACHAS		
Nº ABR	DESCRIÇÃO	QTD
50000741	VEDADOR 44,8 X 2,0 MM	1
50005741	VEDADOR 20,0 X 4,0 MM	8
50006841	VEDADOR 150,5 X 4,0 MM	1
50010341	VEDADOR 23,0 X 3,5 MM	1
50010641	VEDADOR 24,0 X 3,8 MM	2
50010941	VEDADOR 26,0 X 3,2 MM	2
50026241	VEDADOR 88,8 X 3,0 MM	1
50026841	VEDADOR 74,2 X 3,5 MM	1
50028141	VEDADOR 106,7 X 3,5 MM	1
50028841	VEDADOR 126,0 X 5,0 MM	1
50029141	VEDADOR 135,0 X 2,8 MM	1
50034241	VEDADOR 10,2 X 3,2 MM	1
50035141	VEDADOR 62,3 X 3,1 MM	1
50035841	ARRUELA BORRACHA 41,5 X 56,3 X 3,5 MM	1
50036941	VEDADOR 13,0 X 2,5 MM	1
50037141	VEDADOR 14,0 X 3,4 MM	1
50040841	VEDADOR 20,3 X 3,2 MM	8

83727941 KIT DE ARRUELAS			
DESCRIÇÃO	83727829		83728329
	ARRUELA DE COBRE 10,3 X 13,8 X 1,0 MM	1	
ARRUELA DE COBRE 14,1 X 17,8 X 1,0 MM	6		
ARRUELA DE COBRE 16,1 X 21,9 X 1,0 MM	2		
ARRUELA DE COBRE 21,1 X 27,0 X 1,0 MM	6		
ARRUELA DE COBRE 9,6 X 19,9 X 1,5 MM	8		
ARRUELA DE COBRE 9,4 X 24,9 X 1,5 MM	8	1	
ARRUELA DE COBRE 8,2 X 12,2 X 1,0 MM	25	2	
ARRUELA DE ALUMÍNIO 15,2 X 19,9 X 2,0 MM	1	5	
ARRUELA DE ALUMÍNIO 18,2 X 21,9 X 1,0 MM	1		
ARRUELA DE ALUMÍNIO 16,2 X 21,9 X 1,0 MM	2		
ARRUELA DE ALUMÍNIO 20,2 X 25,6 X 1,0 MM	2		
ARRUELA DE ALUMÍNIO 22,0 X 27,0 X 1,5 MM	2		
ARRUELA DE ALUMÍNIO 10,2 X 14,0 X 1,0 MM	1		
ARRUELA DE ALUMÍNIO 12,4 X 15,9 X 1,5 MM	4		
ARRUELA DE ALUMÍNIO 10,0 X 15,9 X 1,0 MM	12		
ARRUELA DE ALUMÍNIO 6,2 X 9,9 X 1,0 MM	21		
ARRUELA DE ALUMÍNIO 14,1 X 17,9 X 1,5 MM	31		

//JOHN DEERE

JOHN DEERE

Nº ABR	MOTOR	DESCRIÇÃO	PÁGINA
60210401	3029D	JOGO DE JUNTAS COMPLETO SEM RETENORES	230
70210401	3029D	JOGO DE JUNTAS COMPLETO COM RETENORES	230
60230401	3029D	JOGO DE JUNTAS SUPERIOR SEM RETENORES	230
60210301	4045T	JOGO DE JUNTAS COMPLETO SEM RETENORES	232
70210301	4045T	JOGO DE JUNTAS COMPLETO COM RETENORES	232
60230301	4045T	JOGO DE JUNTAS SUPERIOR SEM RETENORES	232
60210201	6068D	JOGO DE JUNTAS COMPLETO SEM RETENORES	234
70210201	6068D	JOGO DE JUNTAS COMPLETO COM RETENORES	234
60230201	6068D	JOGO DE JUNTAS SUPERIOR SEM RETENORES	234
60210501	6090T	JOGO DE JUNTAS COMPLETO SEM RETENORES	236
70210501	6090T	JOGO DE JUNTAS COMPLETO COM RETENORES	236
60230501	6090T	JOGO DE JUNTAS SUPERIOR SEM RETENORES	236
60210601	6081T	JOGO DE JUNTAS COMPLETO SEM RETENORES	238
60230601	6081T	JOGO DE JUNTAS SUPERIOR SEM RETENORES	238
60210701	6076T	JOGO DE JUNTAS COMPLETO SEM RETENORES	240
60230701	6076T	JOGO DE JUNTAS SUPERIOR SEM RETENORES	240

Nº JOGO		DESCRIÇÃO			
60210401	JOGO DE JUNTAS COMPLETO JOHN DEERE 3029D SEM RETENTORES		1		
70210401	JOGO DE JUNTAS COMPLETO JOHN DEERE 3029D COM RETENTORES		2		
60230401	JOGO DE JUNTAS SUPERIOR JOHN DEERE 3029D SEM RETENTORES		3		
Nº ABR	Nº ORIGINAL	DESCRIÇÃO			
50203801	R515273	JUNTA DO CABEÇOTE	1	1	1
50202950 •	R75729	JUNTA TAMPA DE VÁLVULA	1	1	1
RE09138T •		RETENTOR TRASEIRO DO VIRABREQUIM		1	
RE09139T •		RETENTOR DIANTEIRO DO VIRABREQUIM		1	
RE09006S •		RETENTOR DA HASTE DAS VÁLVULAS		6	
50203067 •	R97341	JUNTA DO CÁRTER		1	1
50201647 •	R521439	JUNTA COLETOR DE ESCAPAMENTO	3	3	3
50200667	R81275	JUNTA COLETOR ADMISSÃO	2	2	2
50204032	R90737	JUNTA DASE DA TURBINA	1	1	1
50203367	R97352	JUNTA DA ENTRADA DE ÓLEO DO FILTRO		1	1
50201867	R123570	JUNTA DA SÁIDA DO ÓLEO DA TURBINA	1	1	1
50201567	R135896	JUNTA DO TERMOSTATO		1	1
50202567	T20219	JUNTA DO BLOCO DO TERMOSTATO	1	1	1
50202667	T20243	JUNTA DA BOMBA DE ÁGUA		1	1
50202767	T20273	JUNTA DA TAMPA DA DISTRIBUIÇÃO		1	1
50202867	R27285	JUNTA DA BOMBA DE COMBUSTÍVEL		1	1
50203167	R97350	JUNTA DA BOMBA DE COMBUSTÍVEL		1	1
50203267	R97351	JUNTA DA CAIXA DE ENGRENAGEM		1	1
50203467	R97354	JUNTA DA BOMBA DE INJEÇÃO DO COMBUSTÍVEL		1	1
50203567	R97454	JUNTA DA TAMPA DE DISTRIBUIÇÃO		1	1
50203667	R97455	JUNTA DA BOMBA DE ÁGUA		1	1
50203967	R90648	JUNTA DA TAMPA FRONTAL		1	1
50204150	T20328	JUNTA DO FILTRO DO ÓLEO		1	1
80200246		KIT DE BORRACHAS		1	1

• VENDE-SE AVULSO

APLICAÇÃO



JOHN DEERE 3029D/T 3 CILINDROS 2.9 LITROS ASPIRADO E TURBO

JOHN DEERE TRATOR 5055E 2011/...5065E/5075E 2010/...5075EF 2012/...5303 2002/11 5403 2002/12

JOHN DEERE 3029D

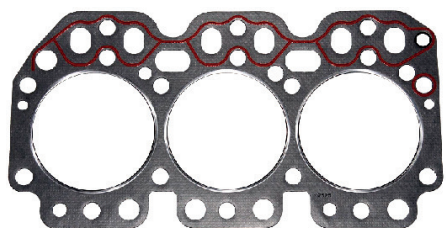

50203801

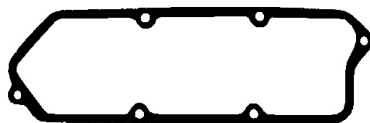

50202950

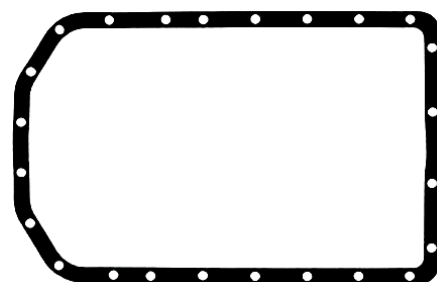

50203067



50203267

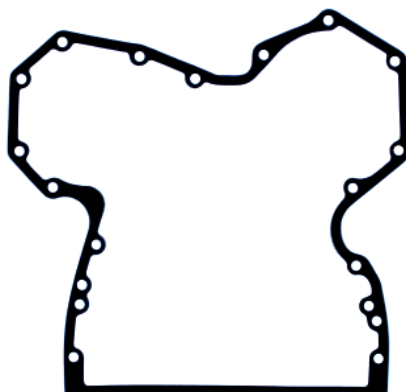

50203567



50203967



50201567



50202667

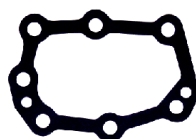

50202767



50203667



50204032



50202567



50201647



50200667



550202867



50203167



50203367



50201867



50203467



50204150



RE09138T



RE09140T



RE0906S

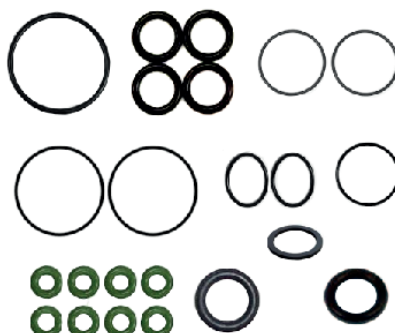

80200446

Nº JOGO		DESCRIÇÃO			
60210301		JOGO DE JUNTAS COMPLETO JOHN DEERE 4045T SEM RETENTORES	1		
70210301		JOGO DE JUNTAS COMPLETO JOHN DEERE 4045T COM RETENTORES	2		
60230301		JOGO DE JUNTAS SUPERIOR JOHN DEERE 4045T SEM RETENTORES	3		
Nº ABR	Nº ORIGINAL	DESCRIÇÃO			
50202401	R116515	JUNTA DO CABEÇOTE	1	1	1
50200467	R136515	JUNTA DA TAMPA FRONTAL		1	1
50200567	R136516	JUNTA DA TAMPA FRONTAL		1	1
50200667	R81275	JUNTA DO COLETOR DE ADMISSÃO	1	1	1
50202340	R524480	JUNTA DA TAMPA DE VÁLVULA	1	1	1
50201647	R521439	JUNTA DO COLETOR DE ESCAPE	4	4	4
RE09138T	RE44574	RETENTOR TRASEIRO DO VIRABREQUIM		1	
RE09140T	RE505515	RETENTOR DIANTEIRO DO VIRABREQUIM		1	
RE09006S	RE31617	RETENTOR DA HASTE DAS VÁLVULAS		8	
50212440		JUNTA DO TERMOSTATO		2	
50202267	R123353	JUNTA DO CARTER		1	1
50200867	R123501	JUNTA DO RESFRIADOR DO ÓLEO		1	1
50201367	R501428	JUNTA DO RESFRIADOR DE ÓLEO		1	1
50200967	R123417	JUNTA DA BOMBA DE ÁGUA		1	1
50201867	R123570	JUNTA SAÍDA DE ÓLEO DA TURBINA	1	1	1
50201767	R53108	JUNTA DO MOTOR DE PARTIDA		1	1
50202130	R92097	JUNTA DA BASE DO TURBO	1	1	1
50200767	R501373	JUNTA DO TERMOSTATO		1	1
50201467	R123345	JUNTA DO TERMOSTATO	1	1	1
50201567	R135896	JUNTA DO TERMOSTATO	1	1	1
50201967	R133893	JUNTA DO TERMOSTATO		1	1
50201067	R502864	JUNTA DO FILTRO DE ÓLEO		1	1
50201167	R123525	JUNTA DO FILTRO DE ÓLEO		1	1
50201267	R501484	JUNTA DO FILTRO DE ÓLEO		1	1
50202067	R136495	JUNTA DO FILTRO DE ÓLEO		1	1
80200246		KIT DE BORRACHA		1	1

• VENDE-SE AVULSO

APLICAÇÃO



JOHN DEERE 4045D/T 4 CILINDROS 4.5 LITROS ASPIRADO E TURBO

JOHN DEERE TRATOR 5078E 2010/...5425N 2006/15 5600 1998/05 5603 2001/12 5605 2002/12 6125J 2009/...5085E/5090E 2010/...

5700 1996/04 5705 2001/11 6110D/6110J/6125D 2009/...6110E/6125E 2010/...6300 1998/04 6405 2002/11 6415 1998/11

JOHN DEERE 4045T

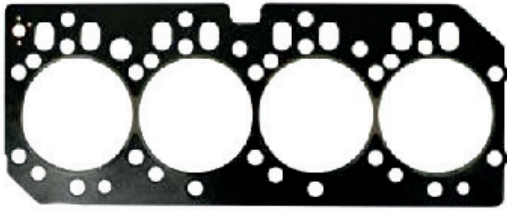

50202401

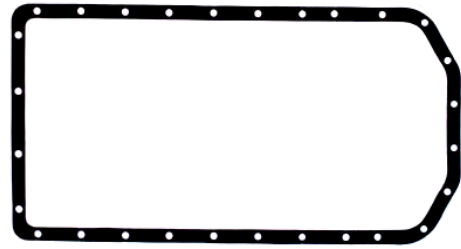

50202267

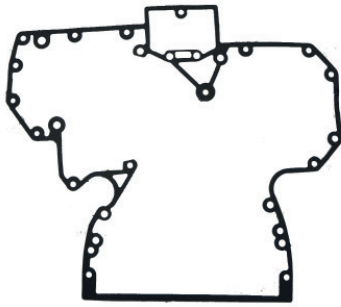

50200667

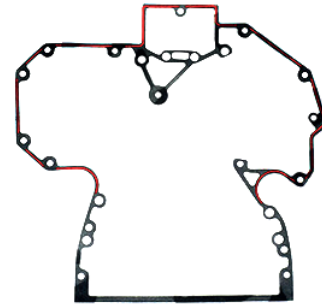

50200567



50202340

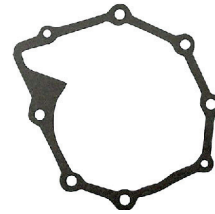

50200967

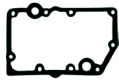

50200867



50201167



50201067



50201367



50201267



50200767



50201647



50200667



50201867



50201767



50201567



50201467



50202130



50202067



50201967



RE09138T



RE09140T



RE09006S



50212440

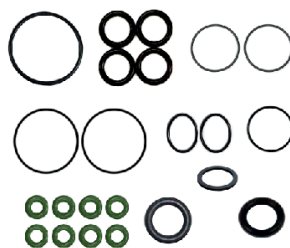

80200246

Nº JOGO		DESCRIÇÃO			
60210201		JOGO DE JUNTAS COMPLETO JOHN DEERE 6068D SEM RETENTORES	1		
70210201		JOGO DE JUNTAS COMPLETO JOHN DEERE 6068D COM RETENTORES	2		
60230201		JOGO DE JUNTAS SUPERIOR JOHN DEERE 6068D SEM RETENTORES	3		
Nº ABR	Nº ORIGINAL	DESCRIÇÃO			
50200101	R116516	JUNTA DO CABEÇOTE	1	1	1
50200340	R123543	JUNTA TAMPA DE VÁLVULA	1	1	1
50200267	R123354	JUNTA DO CÂRTER		1	1
RE09138T	RE44574	RETENTOR TRASEIRO DO VIRABREQUIM		1	
RE09140T	RE505515	RETENTOR DIANTEIRO DO VIRABREQUIM		1	
RE09006S	RE31617	RETENTOR DA HASTE DAS VÁLVULAS		12	
50212440		JUNTA DO TERMOSTATO		2	
50201647	R521439	JUNTA COLETOR DE ESCAPE	6	6	6
50200667	R81275	JUNTA COLETOR ADMISSÃO	1	1	1
52161031	R123572	JUNTA DA BASE DO TURBO	1	1	1
50201867	R123570	JUNTA DA SAIDA DO ÓLEO DA TURBINA	1	1	1
50200467	R136515	JUNTA DA TAMPA FRONTAL		1	1
50200567	R136516	JUNTA DA TAMPA FRONTAL		1	1
50200767	R501373	JUNTA DO TERMOSTATO	1	1	1
50200867	R123501	JUNTA DO RESFRIADOR DE ÓLEO		1	1
50200967	R123417	JUNTA DA BOMBA DE ÁGUA		1	1
50201067	R502864	JUNTA DO FILTRO DE ÓLEO		1	1
50201167	R123525	JUNTA DO FILTRO DE ÓLEO		1	1
50201267	R501484	JUNTA DO FILTRO DE ÓLEO		1	1
50201367	R501428	JUNTA DO RESFRIADOR DE ÓLEO		1	1
50201467	R123345	JUNTA DO TERMOSTATO	1	1	1
50201767	R53108	JUNTA DO MOTOR DE PARTIDA		1	1
50201967	R133893	JUNTA DO TERMOSTATO		1	1
50201567	R135896	JUNTA DO TERMOSTATO	1	1	1
50202067	R136495	JUNTA DO FILTRO DE ÓLEO		1	1
50030724		ARRUELA		1	1
80200246		KIT DE BORRACHA		1	1

• VENDE-SE AVULSO

APLICAÇÃO

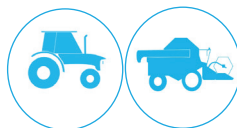

JOHN DEERE 6068D/T 6 CILINDROS 6.8 LITROS ASPIRADO E TURBO

JOHNDEERE TRATOR 6130J/6145J 2010/...6135J 2009/...7715 2006/11 7810 1998/07 7815 2004/11 6165J 2010/17 6600 1995/04

6180J/6205J 2010/...6605 2002/06 6615 2006/11 7185J 2010/12 7195J/7205J 2009/17 7210J 2009/...7225J 2010/17 7500 1999/03 7505 2001/06 7515 2007/11

COLHEITADEIRA S430/S440 2017/...S540/S550 2015/...1165 1998/04 1175 1999/17 1185 1999/09 1250/1450 1998/14 1470 2010/17 9470/9570 2010/15

JOHN DEERE 6068D

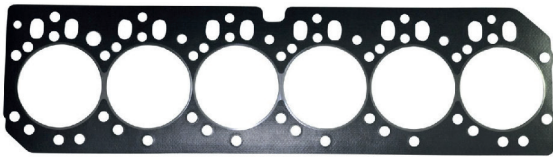

50200101



50200267



50200340

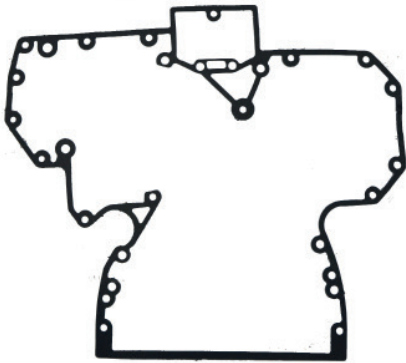

50200467

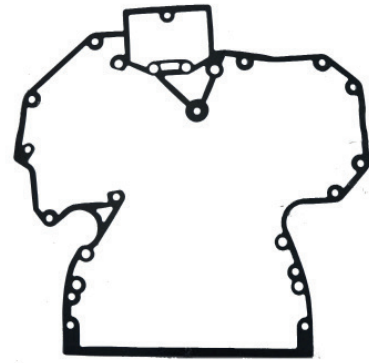

50200567



50201647



50200667



50201867



50201767



50201567



50200867



50200967



50201067



50201167



50201267



50201367



50201967



50202067



50201467



50200767



52161031



50030724



RE09138T



RE09140T



RE09006S



50212440

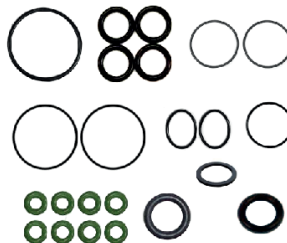

80200246

Nº JOGO		DESCRIÇÃO			
60210501		JOGO DE JUNTAS COMPLETO JOHN DEERE 6090T SEM RETENTORES	1		
70210501		JOGO DE JUNTAS COMPLETO JOHN DEERE 6090T COM RETENTORES	2		
60230501		JOGO DE JUNTAS SUPERIOR JOHN DEERE 6090T SEM RETENTORES	3		
Nº ABR	Nº ORIGINAL	DESCRIÇÃO			
50204301	R525541	JUNTA DO CABEÇOTE	1	1	1
50204540	R526607	JUNTA DA TAMPA DE VÁLVULA	1	1	1
50204447	R527884	JUNTA DA TAMPA DOS BALANCINS	1	1	1
50204867	R100569	JUNTA DO RESPIRO DO CARTER	1	1	1
50204767	RE520777	JUNTA DO CARTER		1	1
50204630	R520844	JUNTA DO CARTER		1	1
50204947	R518260	JUNTA DO COLETOR DE ADMISSÃO	1	1	1
50205067	R519414	JUNTA DO COLETOR DE ADMISSÃO	1	1	1
50205130	R519361	JUNTA DO COLETOR DE ESCAPE	6	6	6
50202130	R92097	JUNTA DA BASE DO TURBO	1	1	1
50205247	R521158	JUNTA DA SAIDA DE ÓLEO DA TURBINA	1	1	1
50205467	R520091	JUNTA DO RESFRIAMENTO DO ÓLEO	1	1	1
50205367	R520547	JUNTA DO RESFRIAMENTO DO ÓLEO		1	1
50205567	RE524105	JUNTA DO RESFRIAMENTO DO ÓLEO		1	1
50205640	R526807	JUNTA DO RESFRIAMENTO DO ÓLEO		1	1
50205740	RE516171	JUNTA DO RESFRIAMENTO DO ÓLEO	2	2	2
50205830	R518619	JUNTA DA RECIRCULAÇÃO DE GASES	3	3	3
50201767	R53108	JUNTA DO MOTOR DE PARTIRDA	1	1	1
50205967	R119383	JUNTA DA ENTRADA DA BOMBA DE ÁGUA		1	1
50206067	R119384	JUNTA DA TAMPA DE DISTRIBUIÇÃO		1	1
50206167	R502011	JUNTA DO ALTERNADOR		1	1
50206267	R522768	JUNTA DA CAIXA DE ENGENHAGEM		1	1
50206340	R527592	JUNTA DO TERMOSTATO	1	1	1
RE09135T	RE520036	RETENTOR DO VIRABREQUIM TRASEIRO		1	
RE09136T	RE542195	RETENTOR DO VIRABREQUIM DIANTEIRO		1	
RE09137F	RE529187	RETENTOR DA HASTE DE VALVULAS		1	
				24	

• VENDE-SE AVULSO

APLICAÇÃO

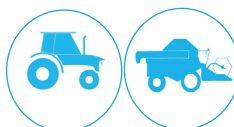

JOHN DEERE 6090T 6 CILINDROS 9.0 LITROS TURBO

JOHN DEERE TRATOR 8245R/8270R 2009/11 8260R 2010/17 8295R/8370R 2015/16 8335R 2011/...8345R 2015/...8320 2008/18

COLHEITADEIRA W650 2008/15 W660 2008/...S660/S670 2013/17 9670 2010/15 9770 2009/15 CH570/CH670 2015/...3520 2010/15

JOHN DEERE 6090T



50204301

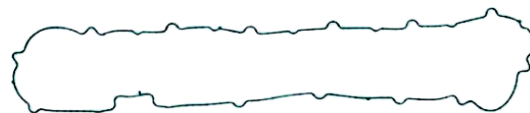

50204540



50204447

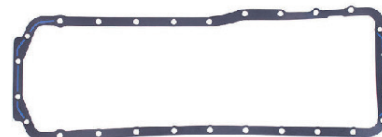

50204767



50204630



50205640



50204947

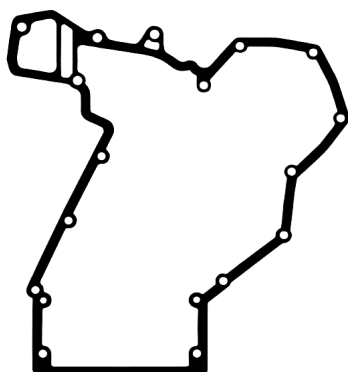

50206067



50205740



50206340



50206267

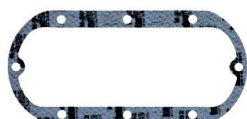

50205567



50205967

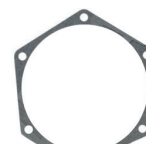

50206167



50205467



50205367



50205247



50201767



50202130



50205067



50204867



50205130



50205830

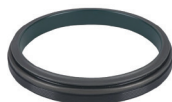

RE09135T



RE09136T



RE09137F

Nº JOGO		DESCRIÇÃO		
60210601		JOGO DE JUNTAS COMPLETO JOHN DEERE 6081T SEM RETENTORES	1	
60230601		JOGO DE JUNTAS SUPERIOR JOHN DEERE 6081T SEM RETENTORES	2	
Nº ABR	Nº ORIGINAL	DESCRIÇÃO		
50206401	R55475	JUNTA DO CABEÇOTE	1	1
50206550	R49866	JUNTA DA TAMPA DE VÁLVULA	1	1
50206767	R130573	JUNTA DO COLETOR DE ADMISSÃO	3	3
50206667	R88993	JUNTA DO COLETOR DE ADMISSÃO DO INTERCOOLER	2	2
50208367	R97347	JUNTA COLETOR DE ADMISSÃO DO INTERCOOLER	2	2
50206917	R83020	JUNTA DO COLETOR DO ESCAPE	2	2
50207017	R83021	JUNTA DO COLETOR DO ESCAPE	2	2
50206067	R119384	JUNTA DA TAMPA DE DISTRIBUIÇÃO		1
50206667	R49377	JUNTA DO CARTER		1
50204867	R100569	JUNTA DO RESPIRO DO CARTER		1
50205967	R119383	JUNTA DA ENTRADA DA BOMBA DE ÁGUA		1
50201867	R123570	JUNTA DA SAÍDA DO ÓLEO DA TURBINA	1	1
52161031	R123572	JUNTA DA BASE DO TURBO	1	1
50205367	R520547	JUNTA DO RESFRIADOR DO ÓLEO		1
50205467	R520091	JUNTA DO RESFRIADOR DO ÓLEO		1
50205567	RE524105	JUNTA DO RESFRIADOR DO ÓLEO		1
50207130	R132396	JUNTA DO RESFRIADOR DO ÓLEO		1
50201767	R53108	JUNTA DO MOTOR DE PARTIDA		1
50206167	R502011	JUNTA DO ALTERNADOR		1
50206267	R522768	JUNTA DA CAIXA DE ENGRENAGEM		1
50207367	R124211	JUNTA DO TERMOSTATO	1	1
50207267	R88397	JUNTA DO TERMOSTATO	2	2
50200767	R124607	JUNTA DO TERMOSTATO	1	1
80200646		KIT DE BORRACHA	1	1

• VENDE-SE AVULSO

APLICAÇÃO

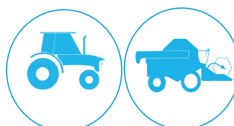

JOHN DEERE TRATOR 8300 1997/03 8320 2008/12 8400 1998/03 8410 2004/11 8420 2005/11 8430 2007/12

COLHEITADEIRA 1550 1998/10 1570 2020/15 9650 1998/02 9660 1998/01 9750/9760 2002/11 9780 1999/...3510 2006/10

JOHN DEERE 6081T

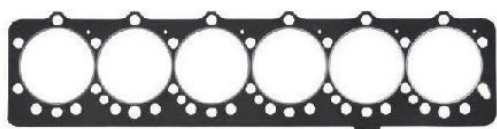

50206401



50206667



50206867



50206550

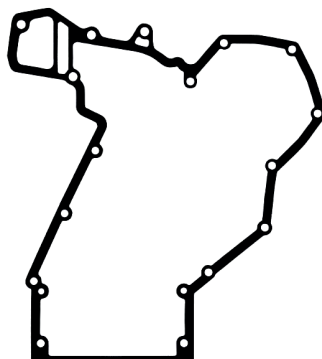

50206067



50208367

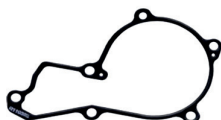

50205967



50206267



50205567

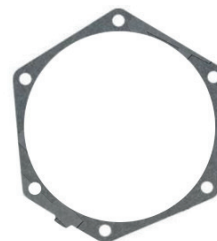

50206167



50201767



50207130



50207567



50207367



52161031



50207467



50207640



50200917



50200767



50201867



50207267



50206767



50207017



50204867



50205367



50205467



RE09136F



RE09137F

Nº JOGO		DESCRIÇÃO		
60210701		JOGO DE JUNTAS COMPLETO JOHN DEERE 6076T SEM RETENTORES	1	
60230701		JOGO DE JUNTAS SUPERIOR JOHN DEERE 6076T SEM RETENTORES	2	
Nº ABR	Nº ORIGINAL	DESCRIÇÃO		
50207701	RE47336	JUNTA DO CABEÇOTE	1	1
50206550	R49866	JUNTA DA TAMPA DE VÁLVULA	1	1
50206767	R130573	JUNTA DO COLETOR DE ADMISSÃO	3	3
50206867	R88993	JUNTA DO COLETOR DE ADMISSÃO	2	2
50206917	R83020	JUNTA DO COLETOR DO ESCAPE	2	2
50207017	R83021	JUNTA DO COLETOR DO ESCAPE	2	2
50208167	R71314	JUNTA DA TAMPA DE DISTRIBUIÇÃO		1
50208267		JUNTA DA TAMPA DE DISTRIBUIÇÃO		1
50208467	R104623	JUNTA DA TAMPA DISTRIBUIÇÃO		1
50208567	R520543	JUNTA DA TAMPA DISTRIBUIÇÃO x2		1
50207867	R520583	JUNTA DO CARTER		1
50206667	R49377	JUNTA DO CARTER		1
50204867	R100569	JUNTA DO RESPIRO DO CARTER		1
50207967	R128557	JUNTA DO RESFRIADOR DO ÓLEO		1
50208067	R128558	JUNTA DO RESFRIADOR ÓLEO		1
50207467	R119847	JUNTA DO FILTRO DE ÓLEO		1
50208967	R43774	JUNTA FILTRO DE ÓLEO		1
50209467	R520580	JUNTA DA BOMBA DE ÁGUA		1
50209367	R43595	JUNTA DA TRASEIRA DO CABEÇOTE		1
50207567	R109625	JUNTA DA VÁLVULA DO RADIADOR		1
50207640	R100911	JUNTA DO TUBO DE ADMISSÃO	1	1
50208667	R100367	JUNTA DA BOMBA DE ÁGUA		1
50209067	R52049	JUNTA DA BOMBA DE ÓLEO		1
50209167	R97346	JUNTA DO INTERCOOLER		1
50209267	R97348	JUNTA DO RETORNO DE ÓLEO TURBINA		1
50209567	R93	JUNTA AUXILIAR DE ACIONAMENTO DE ENGRENAGEM		1
52161031	R123572	JUNTA DA BASE DO TURBO	1	1
50201767	R53108	JUNTA DO MOTOR DE PARTIDA		1
50201867	R123570	JUNTA DA SAÍDA DO ÓLEO DA TURBINA	1	1
50203167	R97350	JUNTA DA BOMBA DE COMBUSTÍVEL		1
50205567	RE524105	JUNTA DO RESFRIADOR DO ÓLEO		2
50208867	R50419	JUNTA DO RESFRIADOR DO ÓLEO		1
50206267	R522768	JUNTA DA CAIXA DE ENGRENAGEM		1
50200767	R124607	JUNTA DO TERMOSTATO	1	1
50207267	R88397	JUNTA DO TERMOSTATO	2	2
50207367	R124211	JUNTA DO TERMOSTATO	1	1
50209667	R86062	JUNTA DO TERMOSTATO	1	1
80200746		KIT DA BORRACHA	1	1

• VENDE-SE AVULSO

APLICAÇÃO



JOHN DEERE TRATOR 8300 1997/03 8320 2008/12 8400 1998/03 8410 2004/11 8420 2005/11 8430 2007/12

COLHEITADEIRA 1550 1998/10 1570 2020/15 9650 1998/02 9660 1998/01 9750/9760 2002/11 9780 1999/...3510 2006/10

JOHN DEERE 6076T

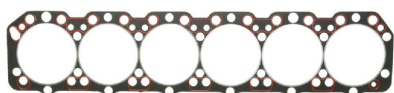

50207701



50206550



50206867



50206667



50207867



50208567

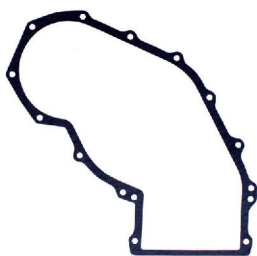

50208567

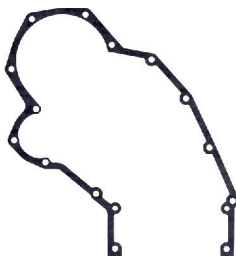

50208467



50207467



50207567



50208867



50208667



50209067



50207567



50208867



50208667



50209067

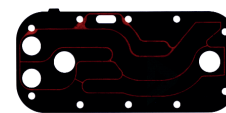

50208067

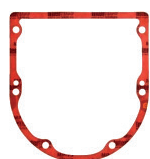

50206267

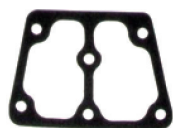

50209367



50200767



50209667



50201767



50209167



50209267



50207017



50200767



50209567



50203167



50204867



50206767



50206917



5216031



50207267



50207640



50207367



52161031



50208967

The image features the Ford logo, which consists of two slanted parallel lines followed by the word "FORD" in a bold, sans-serif font. The logo is centered horizontally and vertically within a white rectangular frame defined by blue lines.

//FORD

FORD

Nº ABR	MOTOR	DESCRIÇÃO		PÁGINA
64113401	4630	JOGO DE JUNTAS COMPLETO	SEM RETENTORES	244
74113401	4630	JOGO DE JUNTAS COMPLETO	COM RETENTORES	244
64133401	4630	JOGO DE JUNTAS SUPERIOR	SEM RETENTORES	244
74133401	4630	JOGO DE JUNTAS SUPERIOR	COM RETENTORES	244
64113301	4600/4610/4810	JOGO DE JUNTAS COMPLETO	SEM RETENTORES	248
74113301	4600/4610/4810	JOGO DE JUNTAS COMPLETO	COM RETENTORES	248
64133301	4600/4610/4810	JOGO DE JUNTAS SUPERIOR	SEM RETENTORES	248
74133301	4600/4610/4810	JOGO DE JUNTAS SUPERIOR	COM RETENTORES	248
64113601	F4000/6600/7610	JOGO DE JUNTAS COMPLETO	SEM RETENTORES	252
74113601	F4000/6600/7610	JOGO DE JUNTAS COMPLETO	COM RETENTORES	252
64133601	F4000/6600/7610	JOGO DE JUNTAS SUPERIOR	SEM RETENTORES	252
64114361	F4000/6600/7610	JOGO DE JUNTAS COMPLETO	SEM RETENTORES	252
64114361	F4000/5610/6600/6610	JOGO DE JUNTAS COMPLETO	SEM RETENTORES	256
64113181	F4000/5610/6600/6610	JOGO DE JUNTAS COMPLETO	COM RETENTORES	256
74113181	F4000/5610/6600/6610	JOGO DE JUNTAS COMPLETO	SEM RETENTORES	256
64133181	F4000/5610/6600/6610	JOGO DE JUNTAS SUPERIOR	SEM RETENTORES	256
64113651	7630	JOGO DE JUNTAS COMPLETO	SEM RETENTORES	260
74113651	7630	JOGO DE JUNTAS COMPLETO	COM RETENTORES	260
64133651	7630	JOGO DE JUNTAS COMPLETO	SEM RETENTORES	260
64113501	5030/5630/6630	JOGO DE JUNTAS COMPLETO	SEM RETENTORES	260
74113501	5030/5630/6630	JOGO DE JUNTAS COMPLETO	COM RETENTORES	260
64133501	7630	JOGO DE JUNTAS COMPLETO	SEM RETENTORES	260
64111093	7830/8030	JOGO DE JUNTAS COMPLETO	SEM RETENTORES	264
74111093	7830/8030	JOGO DE JUNTAS COMPLETO	COM RETENTORES	264
64133091	7830/8030	JOGO DE JUNTAS SUPERIOR	SEM RETENTORES	264
64111081	FASE 1	JOGO DE JUNTAS COMPLETO	SEM RETENTORES	266
74111081	FASE 1	JOGO DE JUNTAS SUPERIOR	COM RETENTORES	266
64131081	FASE 1	JOGO DE JUNTAS SUPERIOR	SEM RETENTORES	266
64131061	FASE 2	JOGO DE JUNTAS SUPERIOR	SEM RETENTORES	266
64111061	FASE 2	JOGO DE JUNTAS COMPLETO	SEM RETENTORES	266
74111061	FASE 2	JOGO DE JUNTAS COMPLETO	COM RETENTORES	266
64115132	TRANSIT 2.4 TDCI	JOGO DE JUNTAS COMPLETO	SEM RETENTORES	270
74115132	TRANSIT 2.4 TDCI	JOGO DE JUNTAS COMPLETO	COM RETENTORES	270
64135132	TRANSIT 2.4 TDCI	JOGO DE JUNTAS SUPERIOR	SEM RETENTORES	270
74135132	TRANSIT 2.4 TDCI	JOGO DE JUNTAS SUPERIOR	COM RETENTORES	270
64115142	OUMA 3.2 TDCI	JOGO DE JUNTAS COMPLETO	SEM RETENTORES	272
74115142	OUMA 3.2 TDCI	JOGO DE JUNTAS COMPLETO	COM RETENTORES	272
64135142	OUMA 3.2 TDCI	JOGO DE JUNTAS SUPERIOR	SEM RETENTORES	272
74135142	OUMA 3.2 TDCI	JOGO DE JUNTAS SUPERIOR	COM RETENTORES	272
74115282	TRANSIT 2.2	JOGO DE JUNTA COMPLETO	COM RETENTORES	274
74118282	TRANSIT 2.2	JOGO DE JUNTA COMPLETO	COM RETENTORES	274

Nº JOGO		DESCRIÇÃO				
64113401	JOGO DE JUNTAS COMPLETO FORD 4630 3 CILINDROS SÉRIE 30 SEM RETENTORES		1			
74113401	JOGO DE JUNTAS COMPLETO FORD 4630 3 CILINDROS SÉRIE 30 COM RETENTORES		2			
64133401	JOGO DE JUNTAS SUPERIOR FORD 4630 3 CILINDROS SÉRIE 30 SEM RETENTORES		3			
74133401	JOGO DE JUNTAS SUPERIOR FORD 4630 3 CILINDROS SÉRIE 30 COM RETENTORES		4			
Nº ABR	Nº ORIGINAL	DESCRIÇÃO				
50051067	D3NN6336A	GAXETA				
54103841	C5NE6571A	VEDADOR DA HASTE DE VÁLVULAS	6	6	6	6
54128701	D8NN6051AA	JUNTA DO CABEÇOTE				
54134150		JUNTA DA VEDAÇÃO DO INJETOR	3	3	3	3
54134298		JUNTA DA TERMOSTATO				
54134398	C7NN9435B	JUNTA DE ADMISSÃO				
54134416	C5NN9435B	JUNTA DO COLETOR DE ESCAPAMENTO	1	1	1	1
54134550		JUNTA DA TAMPA DE VÁLVULAS	1	1	1	1
54134798		JUNTA DA BOMBA DE ÓLEO				
54134890	60,5 X 82,5	JUNTA DO BOCAL				
54134966		JUNTA				
54135090		JUNTA DA BOMBA DE ÁGUA				
54135190	C5NE8507A	JUNTA DO CORPO DA BOMBA DE ÁGUA				
54135290	C5NE9F598	JUNTA DA FLANGE DA BOMBA DE ÁGUA				
54135390	C7NN6N008B	JUNTA DA TAMPA FRONTAL				
54135454	C5NE6N008B	JUNTA DA TAMPA DO RETENTOR				
54135590	C5NE6C045A	JUNTA DA TAMPA DE TRAS DA DISTRIBUIÇÃO				
54135690	C5NE6020A	JUNTA DA TAMPA FRONTAL DA DISTRIBUIÇÃO				
54169267		JUNTA DO CARTER SECCIONADO				
54149016	D3NN56250A	JUNTA DA SAÍDA DO ESCAPAMENTO				
54150690	D3NN9439A	JUNTA DO COLETOR DE ADMISSÃO	1	1	1	1
54152798		JUNTA DA VEDAÇÃO				
54154098		JUNTA DA VEDAÇÃO				
54161550	E5HN6N305C	JUNTA DA PLACA TRASEIRA				
54166898		JUNTA DA BOMBA DE ÁGUA				
54168167	E9NN6N105BB	JUNTA DA TAMPA DO RETENTOR				
54168200	E8NN6051AA	JUNTA DO CABEÇOTE	1	1	1	1
54153750		JUNTA DO TERMOSTATO				
84168340		KIT DE BORRACHA E ARRUELA SUP				
84169140		KIT DE BORRACHA E ARRUELA				
84169740		KIT DE BORRACHA E ARRUELA SUP	1	1	1	1
84170890		KIT DE BORRACHA E ARRUELA SUP				
RE02448S	84170890	RETENTOR DIANTERIO	1	1	1	1
RE02449S		RETENTOR TRASEIRO	1	1	1	1

● VENDE-SE AVULSO

APLICAÇÃO



FORD BSD333 SERIE 10 3 CIL. 3.3L

FORD TRACTOR 4600 1975/99, 4610 1984/99

FORD GENESIS SERIE 30 3 CIL. 3.3L

FORD TRACTOR 4630 1993/98



FORD 4600/4630 SÉRIE 30



54128701



54168200



54134398



54134416



54134550

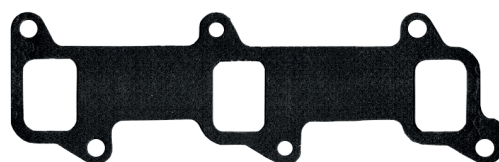

54134416

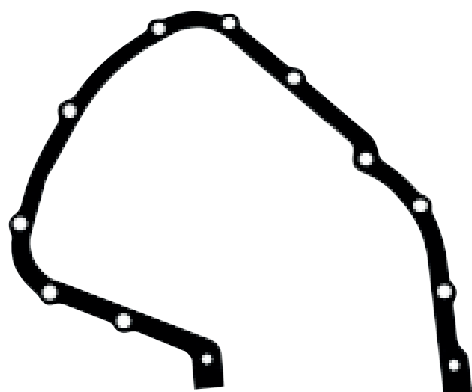

54168167



54135590

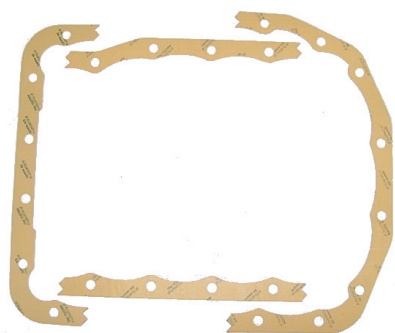

54169267

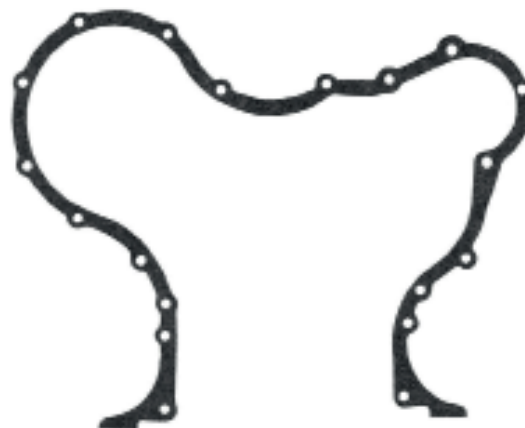

54135690

FORD 4600/4630 SÉRIE 30



54167947



54134798



54134298

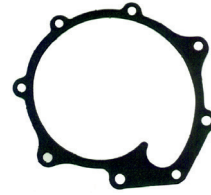

54166898



54149016

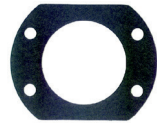

54152798



54135190

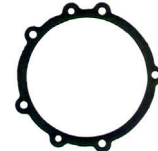

RE02629F



54135090



54153750



54514098

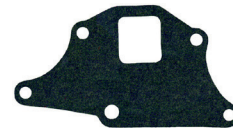

54154098



RE02449S



RE02448S



54134890

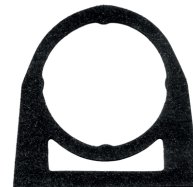

54135454



54161550



54134966



50051067



54134150



54103841

84168340 KIT DE BORRACHAS		
Nº ABR	DESCRIÇÃO	QTD
50003741	ARRUELA DE BORRACHA 7,3 X 11,7 X 2,0 MM	3
50009041	VEDADOR 57,0 X 3,5 MM	1
50011528	ARRUELA DE ALUMÍNIO 8,0 X 12,0 X 1,0 MM	7
50013824	ARRUELA DO BICO INJETOR	3
50027341	VEDADOR 81,5 X 2,5 MM	1
50027366	ARRUELA PH 20,5 X 25,9 X 2,0 MM	1
50029041	VEDADOR 133,0 X 3,3 MM	1
50070166	ARRUELA FB 24,0 X 31,0 X 1,5 MM	1

84170890 KIT DE BORRACHAS		
Nº ABR	DESCRIÇÃO	QTD
50003741	ARRUELA DE BORRACHA 7,3 X 11,7 X 2,0 MM	3
50013824	ARRUELA DO BICO INJETOR	3

84169140 KIT DE BORRACHAS		
Nº ABR	DESCRIÇÃO	QTD
50003741	ARRUELA DE BORRACHA 7,3 X 11,7 X 2,0 MM	3
50009041	VEDADOR 57,0 X 3,5 MM	3
50011528	ARRUELA DE ALUMÍNIO 8,0 X 12,0 X 1,0 MM	7
50013824	ARRUELA DO BICO INJETOR	3
50027341	VEDADOR 81,5 X 2,5 MM	1
50027366	ARRUELA PH 20,5 X 25,9 X 2,0 MM	1
50029041	VEDADOR 133,0 X 3,3 MM	1

84169740 KIT DE BORRACHAS		
Nº ABR	DESCRIÇÃO	QTD
50003741	ARRUELA DE BORRACHA 7,3 X 11,7 X 2,0 MM	3
50013824	ARRUELA DO BICO INJETOR	3

Nº JOGO		DESCRIÇÃO				
64113301	JOGO DE JUNTAS COMPLETO FORD 4600/4610/4810 SÉRIE 10 SEM RETENTORES		1			
74113301	JOGO DE JUNTAS COMPLETO FORD 4600/4610/4810 SÉRIE 10 COM RETENTORES		2			
64133301	JOGO DE JUNTAS SUPERIOR FORD 4600/4610/4810 SÉRIE 10 SEM RETENTORES		3			
74133301	JOGO DE JUNTAS SUPERIOR FORD 4600/4610/4810 SÉRIE 10 COM RETENTORES		4			
Nº ABR	Nº ORIGINAL	DESCRIÇÃO				
50051067	D3NN6336A	GAXETA			2	2
54103841	C5NE6571A	VEDADOR DA HASTE DE VÁLVULAS	6	6	6	6
54128701	D8NN6051AA	JUNTA DO CABEÇOTE	1	1	1	1
54134150		JUNTA DA VEDAÇÃO DO INJETOR	3	3	3	3
54134298		JUNTA DO TERMOSTATO		1	1	
54134398	C7NN9435B	JUNTA DE ADMISSÃO	1	1	1	1
54134416	C5NN9435B	JUNTA DO COLETOR DO ESCAPAMENTO	1	1	1	1
54134550		JUNTA DA TAMPA DE VÁLVULAS	1	1	1	1
54134798		JUNTA DA BOMBA DE ÓLEO			1	1
54134890	60,5 X 82,5	JUNTA DO BOCAL			1	1
54134966		JUNTA			1	1
54135090		JUNTA DA BOMBA DE ÁGUA			1	1
54135190	C5NE8507A	JUNTA DO CORPO DA BOMBA DE ÁGUA			1	1
54135290	C5NE9F598	JUNTA DA FLANGE DA BOMBA DE ÁGUA			1	1
54135390	C7NN6N008B	JUNTA DA TAMPA FRONTAL			1	1
54135454	C5NE6N008B	JUNTA DA TAMPA DO RETENTOR			1	1
54135590	C5NE6C045A	JUNTA DA TAMPA DE TRAS DA DISTRIBUIÇÃO			1	1
54135690	C5NE6020A	JUNTA DA TAMPA FRONTAL DA DISTRIBUIÇÃO			1	1
54169267		JUNTA DO CARTER SECCIONADO			1	1
54149016	D3NN56250A	JUNTA DA SAÍDA DO ESCAPAMENTO	1	1	1	1
54150690	D3NN9439A	JUNTA DO COLETOR DE ADMISSÃO			1	1
54152798		JUNTA DA VEDAÇÃO			1	1
54154098		JUNTA DA VEDAÇÃO			1	1
54161550	E5HN6N305C	JUNTA DA PLACA TRASEIRA			1	1
54166898		JUNTA DA BOMBA DE ÁGUA				
54168167	E9NN6N105BB	JUNTA DA TAMPA DO RETENTOR	1			
54168200	E8NN6051AA	JUNTA DO CABEÇOTE			1	1
54153750		JUNTA DO TERMOSTATO			1	1
84168340		KIT DE BORRACHA E ARRUELA DO JOGO SUPERIOR				
84169140		KIT DE BORRACHA E ARRUELA				
84169740		KIT DE BORRACHA E ARRUELA DO JOGO SUPERIOR	1			
84170890		KIT DE BORRACHA E ARRUELA DO JOGO SUPERIOR		1		
RE02448S	84170890	RETENTOR DIANTERIO	1		1	
RE02449S		RETENTOR TRASEIRO	1		1	

• VENDE-SE AVULSO

APLICAÇÃO



FORD BSD333 SERIE 10 3 CIL. 3.3LITROS

FORD TRACTOR 4600 1975/99, 4610 1984/99

FORD GENESIS SERIE 30 3 CILINDROS 3.3LITROS

FORD TRATOR 4630 1993/98



FORD 4600/4610/4810 SÉRIE 10

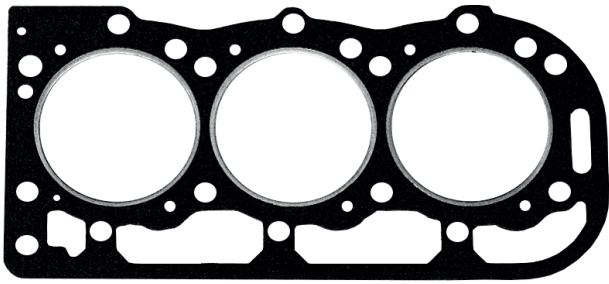

54128701

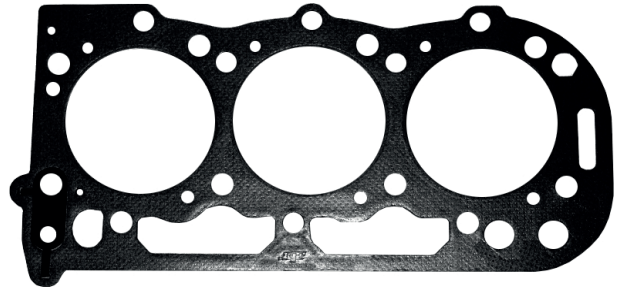

54168200



54134398



54134416

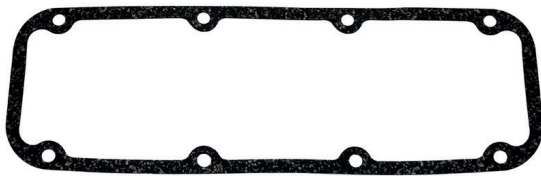

54134550

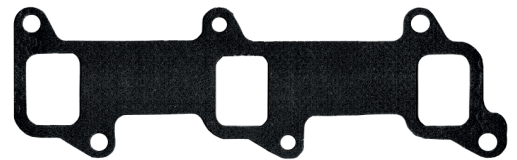

54134416

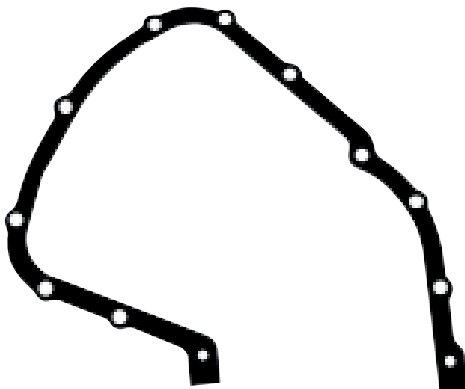

54168167



54135590

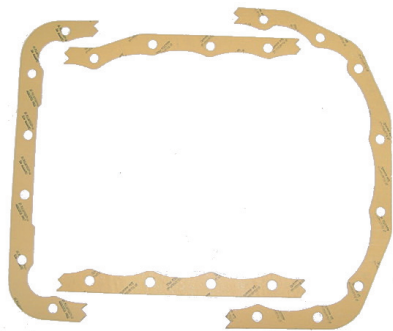

54169267

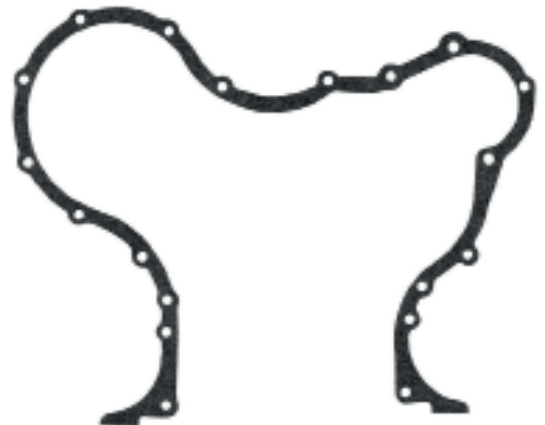

54135690

FORD 4600/4610/4810 SÉRIE 10



54167947



54134798



54134298

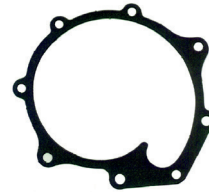

54166898



54149016

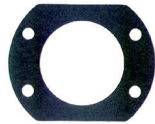

54152798



54135190

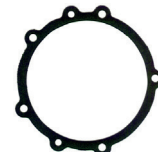

RE02629F



54135090



54153750



54514098



54154098



RE02449S



RE02448S



54134890

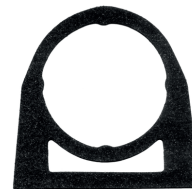

54135454



54161550



54134966



50051067



54134150



54103841

84168340 KIT DE BORRACHAS

Nº ABR	DESCRIÇÃO	QTD
50003741	ARRUELA DE BORRACHA 7,3 X 11,7 X 2,0 MM	3
50009041	VEDADOR 57,0 X 3,5 MM	1
50011528	ARRUELA DE ALUMÍNIO 8,0 X 12,0 X 1,0 MM	7
50013824	ARRUELA DO BICO INJETOR	3
50027341	VEDADOR 81,5 X 2,5 MM	1
50027366	ARRUELA PH 20,5 X 25,9 X 2,0 MM	1
50029041	VEDADOR 133,0 X 3,3 MM	1
50070166	ARRUELA FB 24,0 X 31,0 X 1,5 MM	1

84170890 KIT DE BORRACHAS

Nº ABR	DESCRIÇÃO	QTD
50003741	ARRUELA DE BORRACHA 7,3 X 11,7 X 2,0 MM	3
50013824	ARRUELA DO BICO INJETOR	3

84169140 KIT DE BORRACHAS

Nº ABR	DESCRIÇÃO	QTD
50003741	ARRUELA DE BORRACHA 7,3 X 11,7 X 2,0 MM	3
50009041	VEDADOR 57,0 X 3,5 MM	3
50011528	ARRUELA DE ALUMÍNIO 8,0 X 12,0 X 1,0 MM	7
50013824	ARRUELA DO BICO INJETOR	3
50027341	VEDADOR 81,5 X 2,5 MM	1
50027366	ARRUELA PH 20,5 X 25,9 X 2,0 MM	1
50029041	VEDADOR 133,0 X 3,3 MM	1

84169740 KIT DE BORRACHAS

Nº ABR	DESCRIÇÃO	QTD
50003741	ARRUELA DE BORRACHA 7,3 X 11,7 X 2,0 MM	3
50013824	ARRUELA DO BICO INJETOR	3

Nº JOGO		DESCRIÇÃO				
64113601	JOGO DE JUNTAS COMPLETO FORD 7610 4 CILINDROS SÉRIE 10 SEM RETENTORES		1			
74113601	JOGO DE JUNTAS COMPLETO FORD 7610 4 CILINDROS SÉRIE 10 COM RETENTORES		2			
64133601	JOGO DE JUNTAS SUPERIOR FORD 7610 4 CILINDROS SÉRIE 10 SEM RETENTORES		3			
64114361	JOGO DE JUNTAS COMPLETO FORD F4000 MT FNH SEM RETENTORES		4			
Nº ABR	Nº ORIGINAL	DESCRIÇÃO				
50051067	D3NN6336A	GAXETA	2			
52111731		JUNTA DA BASE DA TURBINA		1	1	1
54103841	C5NE6571A	JUNTA DA VEDAÇÃO DA HASTE DE VÁLVULAS	8	8	8	8
54127201	E0NN6051A	JUNTA DO CABEÇOTE	1	1	1	1
54134150		JUNTA DA VEDAÇÃO DO INJETOR	4	4	4	4
54134298		JUNTA DO TERMOSTATO	1		1	1
54134798		JUNTA DA BOMBA DE ÓLEO DO CARTER	1		1	1
54134890	60,5X82,5	JUNTA DO BOCAL	1			
54134966		JUNTA	1			
54135090		JUNTA DA BOMBA DE ÁGUA	1	1	1	1
54135190	C5NE8507A	JUNTA DO CORPO DA BOMBA DE ÁGUA	1			
54135290	C5NE9F598	JUNTA DA FLANGE DA BOMBA DE ÁGUA	1		1	1
54135390	C7NN6N008B	JUNTA DA TAMPA FRONTAL	1		1	1
54135454	C5NE6C045A	JUNTA DA TAMPA DO RETENTOR	1			
54135590	C5NE6020A	JUNTA DA TAMPA DE TRAS DA DISTRIBUIÇÃO	1		1	1
54135690	C7NN6S84C	JUNTA DA TAMPA FRONTAL DA DISTRIBUIÇÃO	1		1	1
54137150		JUNTA DA TAMPA DE VÁLVULAS	1	1	1	1
54139090	C5NE9448B	JUNTA DO COLETOR DE ADMISSÃO				
54139116		JUNTA DO COLETOR DE ESCAPAMENTO	1	1	1	1
54169367	D4NN6710A	JUNTA DO CARTER	1			
54139296	D3NN56250A	JUNTA DO CARTER			1	1
54149016	D3NN9439B	JUNTA DA SAÍDA DO ESCAPAMENTO	1	1	1	1
54150790	E1TN9439BA	JUNTA DO COLETOR DE ADMISSÃO				
54152198		JUNTA DO COLETOR DE ADMISSÃO	1			
54152798		JUNTA DA VEDAÇÃO	1			
54153750	C5NE8507A	JUNTA DO TERMOSTATO	1			
54154098		JUNTA DA FLANGE DA BOMBA DE ÁGUA	1			
54155596	E5HN6N40AA	JUNTA DO RETORNO DE ÓLEO	1	1	1	1
54155631		JUNTA DA BASE DA TURBINA	1	1	1	1
54155798	E5HN6N305C	JUNTA DA ENTRADA DE ÓLEO	1	1	1	1
54161550		JUNTA DA PLACA TRASEIRA	1		1	1
54166898		JUNTA DA BOMBA DE ÁGUA	1		1	1
54167947		JUNTA DA SAÍDA DO ESCAPAMENTO		1	1	1
54169167		JUNTA DO COLETOR DE ADMISSÃO		1	1	1
84168240		KIT DE BORRACHA E ARRUELA	1			
84169540		KIT DE BORRACHA E ARRUELA			1	1
84170140		KIT DE BORRACHA E ARRUELA DO JOGO SUPERIOR		1		
RE02448S		RETENTOR DIANTEIRO				1
RE02449S		RETENTOR TRASEIRO				1

● VENDE-SE AVULSO



APLICAÇÃO

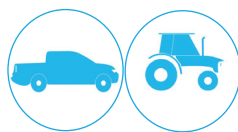

FORD BSD444 SERIE 10 4 CILINDROS. 4.4 LITROS

FORD TRACTOR 6600 1978/98 ; 5610/6610/6710 1984/98 ; 7610 1985/00

FORD FNH 268 4 CILINDROS 4.4LITROS

FORD PICK-UP F2000/F4000 1982/89

FORD BSD444T SERIE 10 4 CILINDROS 4.4LITROS

FORD TRACTOR 7610 1985/00

FORD F4000/6600/7610



50965504

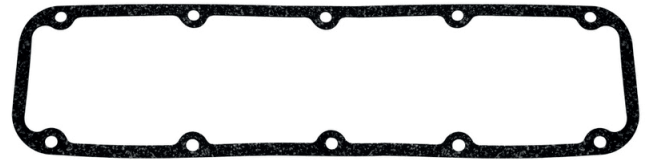

50918655

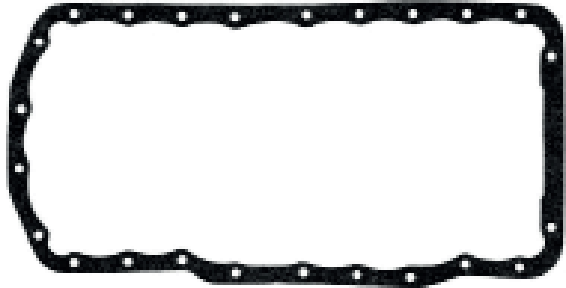

50965504

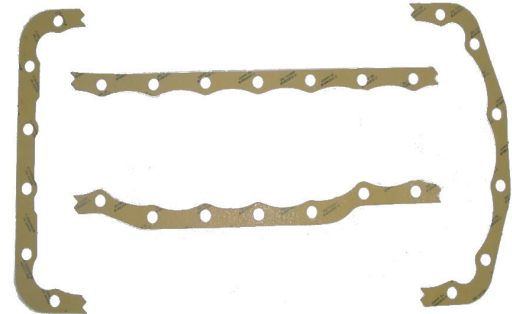

50918655



50965504

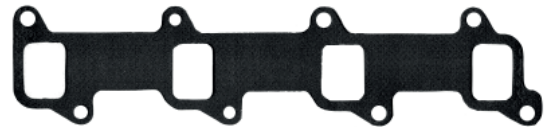

50918655



50965504



50918655



50965504



54370867

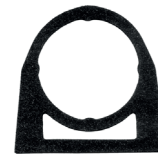

58311632

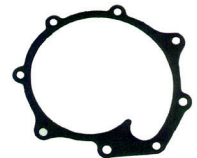

RE02629F



5437067



54370867



58311632



RE02629F

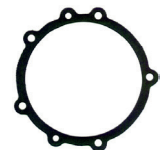

RE02629F



5437067



54370867



58311632



RE02629F



RE02629F



5437067



54370867



58311632

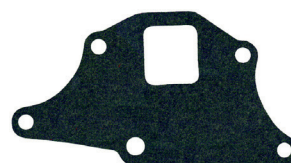

RE02629F



RE02629F

Nº JOGO		DESCRIÇÃO				
64114361	JOGO DE JUNTAS COMPLETO FORD F4000 MT FNH 268 4 CILINDROS SEM RETENTORES		1			
64113181	JOGO DE JUNTAS COMPLETO FORD 5610/6600/6610 4 CILINDROS SÉRIE 10 SEM RETENTORES		2			
74113181	JOGO DE JUNTAS COMPLETO FORD 5610/6600/6610 4 CILINDROS SÉRIE 10 COM RETENTORES		3			
64133181	JOGO DE JUNTAS SUPERIOR FORD 5610/6600/6610 4 CILINDROS SÉRIE 10 SEM RETENTORES		4			
Nº ABR	Nº ORIGINAL	DESCRIÇÃO				
50051067	D3NN6336A	GAXETA	2	2	2	
52111731		JUNTA DA BASE DA TURBINA				
54103841	C5NE6571A	JUNTA DA VEDAÇÃO DA HASTE DE VÁLVULAS	8	8	8	
54127201	E0NN6051A	JUNTA DO CABEÇOTE	1	1	1	
54134150		JUNTA DA VEDAÇÃO DO INJETOR	4	4	4	
54134298		JUNTA DO TERMOSTATO	1	1	1	
54134798		JUNTA DA BOMBA DE ÓLEO DO CARTER	1	1	1	
54134890	60,5X82,5	JUNTA DO BOCAL	1	1	1	
54134966		JUNTA	1	1	1	
54135090		JUNTA DA BOMBA DE ÁGUA	1	1	1	
54135190	C5NE8507A	JUNTA DO CORPO DA BOMBA DE ÁGUA	1	1	1	
54135290	C5NE9F598	JUNTA DA FLANGE DA BOMBA DE ÁGUA	1	1	1	
54135390	C7NN6N008B	JUNTA DA TAMPA FRONTAL	1	1	1	
54135454	C5NE6C045A	JUNTA DA TAMPA DO RETENTOR	1	1	1	
54135590	C5NE6020A	JUNTA DA TAMPA DE TRAS DA DISTRIBUIÇÃO	1	1	1	
54135690	C7NN6584C	JUNTA DA TAMPA FRONTAL DA DISTRIBUIÇÃO	1	1	1	
54137150		JUNTA DA TAMPA DE VÁLVULAS	1	1	1	
54139090	C5NE9448B	JUNTA DO COLETOR DE ADMISSÃO	1	1	1	
54139116		JUNTA DO COL ETOR DE ESCAPAMENTO	1	1	1	
54169367	D4NN6710A	JUNTA DO CARTER			1	
54139296	D3NN56250A	JUNTA DO CARTER	1	1		
54149016	D3NN9439B	JUNTA DA SAÍDA DO ESCAPAEMNTO	1	1	1	
54150790	E1TN9439BA	JUNTA DO COLETOR DE ADMISSÃO	1	1	1	
54152198		JUNTA DO COLETOR DE ADMISSÃO			1	
54152798		JUNTA DA VEDAÇÃO	1	1	1	
54153750	C5NE8507A	JUNTA DO TERMOSTATO	1	1	1	
54154098		JUNTA DA FLANGE DA BOMBA DE ÁGUA	1	1	1	
54155596	E5HN6N40AA	JUNTA DO RETORNO DO ÓLEO			1	
54155631		JUNTA DA BASE DA TURBINA			1	
54155798	E5HN6N305C	JUNTA DA ENTRADA DO ÓLEO			1	
54161550		JUNTA DA PLACA TRASEIRA	1	1	1	
54166898		JUNTA DA BOMBA DE ÁGUA	1	1	1	
54167947		JUNTA DA SAÍDA DO ESCAPAMENTO				
54169167		JUNTA DO COLETOR DE ADMISSÃO				
84168240		KIT DE BORRACHA E ARRUELA	1	1	1	
84169540		KIT DE BORRACHA E ARRUELA				
84170140		KIT DE BORRACHA E ARRUELA DO JOGO SUPERIOR	1			
RE02448S		RETENTOR DIANTEIRO	1		1	
RE02449S		RETENTOR TRASEIRO	1		1	

● VENDE-SE AVULSO



APLICAÇÃO

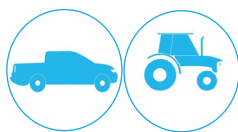

FORD BSD444 SERIE 10 4 CILINDROS 4.4LITROS

FORD TRACTOR 6600 1978/98 ; 5610/6610/6710 1984/98 ; 7610 1985/00

FORD FNH 268 4 CILINDROS 4.4LITROS

FORD PICK-UP F2000/F4000 1982/89

FORD BSD444T SERIE 10 4 CILINDROS 4.4LITROS

FORD TRACTOR 7610 1985/00

FORD F4000/5610/6600/6610



50965504

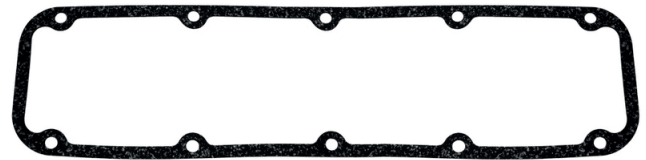

50918655

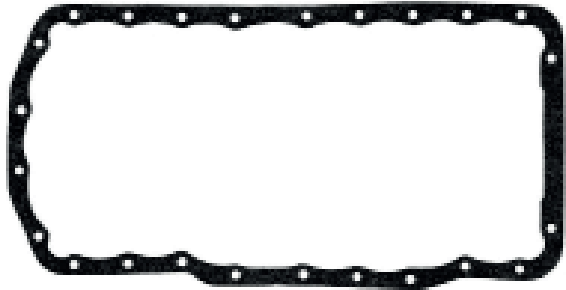

50965504

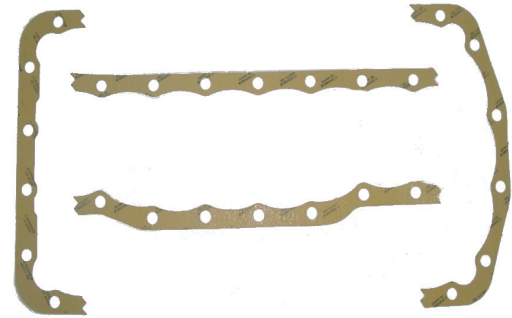

50918655



50965504



50918655



50965504



50918655



50965504



54370867

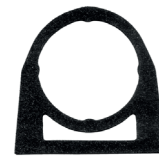

58311632

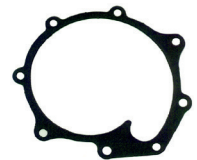

RE02629F



5437067



54370867



58311632



RE02629F

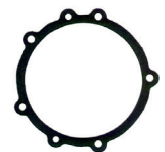

RE02629F



5437067



54370867



58311632



RE02629F



RE02629F



5437067



54370867



58311632

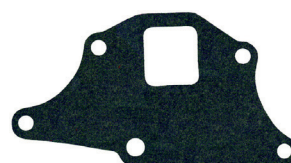

RE02629F



RE02629F

FORD 5630/6630/7630 4 CILINDROS

Nº JOGO	DESCRIÇÃO
64113651	JOGO DE JUNTAS COMPLETO 7630 4 CILINDROS SÉRIE 30 SEM RETENTORES
74113651	JOGO DE JUNTAS COMPLETO 7630 4 CILINDROS SÉRIE 30 COM RETENTORES
64133651	JOGO DE JUNTAS COMPLETO 7630 COM RETIFICA VÁLVULA 4 CILINDROS SÉRIE 30 SEM RETENTORES
64113501	JOGO DE JUNTAS COMPLETO 5030/5630/6630 4 CILINDROS SÉRIE 30 SEM RETENTORES
74113501	JOGO DE JUNTAS COMPLETO 5030/5630/6630 4 CILINDROS SÉRIE 30 COM RETENTORES
64133501	JOGO DE JUNTAS COMPLETO 7630 COM RETIFICA VÁLVULA 4 CILINDROS SÉRIE 30 SEM RETENTORES

Nº ABR	Nº ORIGINAL	DESCRIÇÃO	1	2	3	4	5	6
52111731		JUNTA DA BASE DA TURBINA	1	1	1	1	1	1
54103841	C5NE6571A	RETENTOR DA HASTE DE VÁLVULAS	8	8	8	8	8	8
54134150		VEDAÇÃO DO INJETOR	4	4	4	4	4	4
54134298		JUNTA DO TERMOSTATO		1	1		1	1
54134798		JUNTA DA BOMBA DO ÓLEO DO CARTER		1	1		1	1
54134890		JUNTA DO BOCAL		1	1		1	1
54135090		JUNTA DA BOMBA DE ÁGUA					1	1
54135190		JUNTA DO CORPO DA BOMBA DE ÁGUA		1	1		1	1
54135290	C5NE8507A	JUNTA DA FLANGE DA BOMBA DE ÁGUA		1	1		1	1
54135390	C5NE9F598	JUNTA DA TAMPA FRONTAL		1	1		1	1
54135590	C5NE6C045A	JUNTA DA TAMPA DA DISTRIBUIÇÃO TRASEIRA		1	1	1	1	1
54135690	CSNE6020A	JUNTA DA TAMPA DA DISTRIBUIÇÃO FRONTAL		1	1	1	1	1
54137150	C7NN6584C	JUNTA DA TAMPA DE VÁLVULAS	1	1	1	1	1	1
54169337	541169337	54169337*		1	1	1	1	1
54149016	D3NN56250A	JUNTA DA SAÍDA DO ESCAPAMENTO	1	1	1	1	1	1
54153750		JUNTA DO TERMOSTATO		1	1		1	1
54155596		JUNTA DO RETORNO DO ÓLEO DA TURBINA	1	1	1	1	1	1
54155631	ESHN6N640AA	JUNTA DA BASE DA TURBINA					1	1
54155798		JUNTA DA ENTRADA DE ÓLEO DA TURBINA	1	1	1	1	1	1
54166898		JUNTA DA BOMBA DE ÁGUA		1	1		1	1
54167647	E9NN94488A	JUNTA DO COLETOR DO ESCAPAMENTO	1	1	1	1	1	1
54168067	F0NN9439AA	JUNTA DO COLETOR DE ADMISSÃO	1	1	1	1	1	1
54168167	E9NN6N105BB	JUNTA DA TAMPA DO RETENTOR		1	1		1	1
54168300	F1NN6051BA	JUNTA DO CABEÇOTE	1	1	1	1	1	1
84169340		KIT DE BORRACHA E ARRUELA		1	1		1	1
84169326	84169326	KIT DE BORRACHA E ARRUELA DO JOGO SUPERIOR	1	1				
RE02448S	RE02448S	RETENTOR DIANTEIRO					1	1
RE02449S	RE02449S	RETENTOR TRASEIRO					1	1
54139090		JUNTA DO COLETOR DE ADMISSÃO	1	1	1	1	1	1

• VENDE-SE AVULSO

APLICAÇÃO



FORD TRACTOR 5030/5630/6630 1993/98

FIAT TRACTOR FB80.2 1996/...

FORD TRACTOR 7630 1995/07 TS100/110 1999/08 TS90 1999/09



FORD 5630/6630/7630 4 CILINDROS

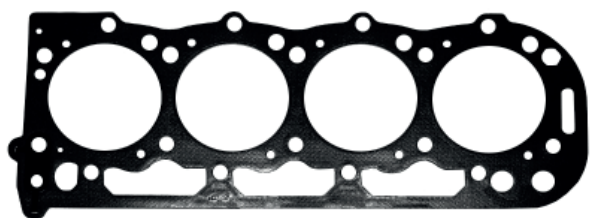

54168300



54137150

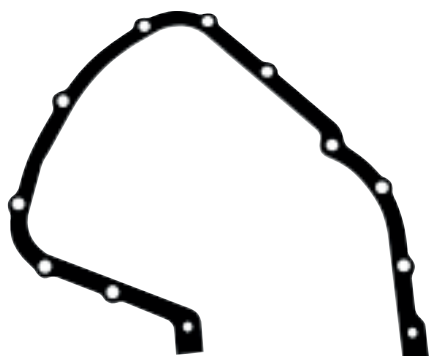

54168167

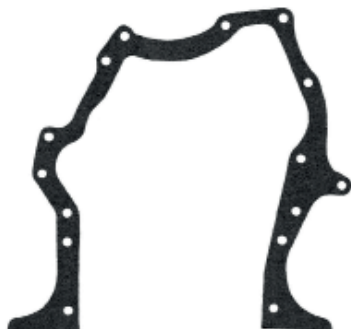

54135590

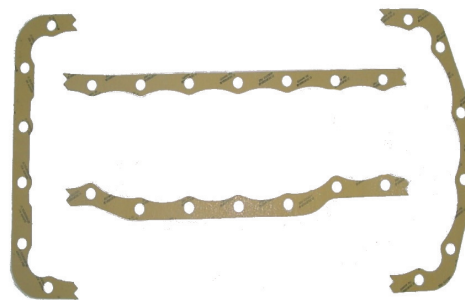

54169367



54168067



54139090



54167647

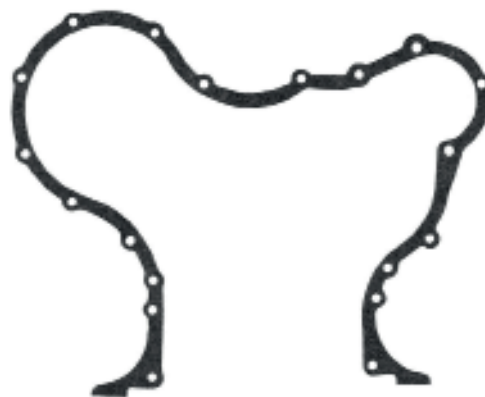

54135690



54155798



54155596



54134798



54149016



54134298



54135190



52111731



54155631



54135290

FORD 5630/6630/7630 4 CILINDROS



54135090



54153750

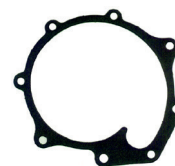

541666898



54152798



54134966

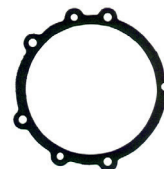

54135390



RE02449S



RE02448S



54134890



50051067



54134150



54103841

84170140 KIT DE BORRACHAS		
Nº ABR	DESCRIÇÃO	QTD
50003741	ARRUELA DE BORRACHARRACHA 7,3X11,7X2,0 MM	4
50070166	ARRUELA DO BICO INJETOR	4

84168240 KIT DE BORRACHAS		
Nº ABR	DESCRIÇÃO	QTD
50003741	ARRUELA DE BORRACHA 7,3X11,7X2,0 MM	4
50009041	VEDADOR 57,0X3,5 MM	1
50011528	ARRUELA DE ALUMÍNIO 8,0X12,0X1,0 MM	8
50013824	ARRUELA DO BICO INJETOR	4
50015428	ARRUELA DE ALUMÍNIO 10,0X14,0X1,0 MM	1
50017696	ARRUELA PH 11,4X17,9X1,6 MM	4
50027341	VEDADOR 81,5X2,5 MM	1
50027366	ARRUELA PH 20,5X25,9X2,0 MM	4
50029041	VEDADOR 133,0X3,3 MM	1
50051050	ARRUELA CE 21,5X32,5X1,0 MM	4
50070166	ARRUELA FB 24,0X31,0X1,5 MM	1

84169740 KIT DE BORRACHAS		
Nº ABR	DESCRIÇÃO	QTD
50003741	ARRUELA DE BORRACHA 7,3X11,7X2,0 MM	3
50009041	VEDADOR 57,0X3,5 MM	3
50011528	ARRUELA DE ALUMÍNIO 8,0X12,0X1,0 MM	7
50013824	ARRUELA DO BICO INJETOR	3
50027341	VEDADOR 81,5X2,5 MM	1
50027366	ARRUELA PH 20,5X25,9X2,0 MM	1
50029041	VEDADOR 133,0X3,3 MM	1

7830/8030 6 CILINDROS

Nº JOGO		DESCRIÇÃO			
64111093	JOGO DE JUNTAS COMPLETO FORD 7830/8030 6 CILINDROS SEM RETENTORES		1		
74111093	JOGO DE JUNTAS COMPLETO FORD 7830/8030 6 CILINDROS COM RETENTORES		2		
64133091	JOGO DE JUNTAS SUPERIOR FORD 7830/8030 6 CILINDROS SEM RETENTORES		3		
Nº ABR	Nº ORIGINAL	DESCRIÇÃO			
52111731		JUNTA DA BASE DA TURBINA	1	1	1
54168167	E9NN6N105BB	JUNTA DA TAMPA DO RETENTOR		1	1
54103841	C5NR6571A	RET ENTOR DA HASTE DE VÁLVULAS			
54135690	C5NE6020A	JUNTA DA TAMPA DO DISTRIBUIDOR FRONTAL	1	1	
54135590	C5NE6C045A	JUNTA DA TAMPA DO DISTRIBUIDOR TRASEIRA	1	1	
54135290	C5NE8507A	JUNTA DA FLANGE DA BOMBA DE ÁGUA	1	1	
54135390	C5NE9F598	JUNTA DA TAMPA FRONTAL	1	1	
54134150		VEDAÇÃO DO INJETOR	6	6	6
54134798		JUNTA DA BOMBA DO ÓLEO DO CARTER	1	1	
54155596		JUNTA DO RETORNO DO ÓLEO DA TURBINA	1	1	1
54155798		JUNTA DA ENTRADA DO ÓLEO DA TURBINA	1	1	1
54154098	C5NE8507A	JUNTA DA FLANGE DA BOMBA DE ÁGUA	1	1	
54154570	ESHN8507AA	JUNTA DO BLOCO DA BOMBA DE ÁGUA	1	1	
54166898		JUNTA DA BOMBA DE ÁGUA	1	1	
54153750		JUNTA DO TERMOSTATO	1	1	
54152450	ESHN6584AA	JUNTA DA TAMPA DE VÁLVULA	1	1	
54167718	E9NN9448AA	JUNTA DO COLETOR DE ESCAPAMENTO	1	1	1
54167867		JUNTA DO COLETOR DE ADMISSÃO	2	2	2
54172301	E9HN6051BA	JUNTA DO CABEÇOTE	1	1	1
54169567	E3HN6710AA	JUNTA A CARTER			
84168840		KIT DE BORRACHA E ARRUELA	1	1	
84168826		KIT DE BORRACHA E ARRUELA	1	1	
RE02448S		RETENTOR DIANTEIRO			1
RE02449S		RETENTOR TRASEIRO			1
54134298		RETENTOR TERMOSTATO	1	1	

• VENDE-SE AVULSO

APLICAÇÃO



FORD TRACTOR 7830 1993/98 8030 1993/07 TM120/130/135/150 2000/08 TM140 1998/08 TM165/180 2001/08 TS120 1999/08

7830/8030 6 CILINDROS

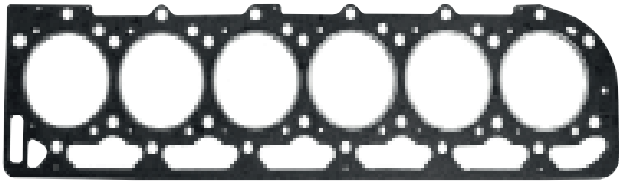

54172301



54152450



54167867

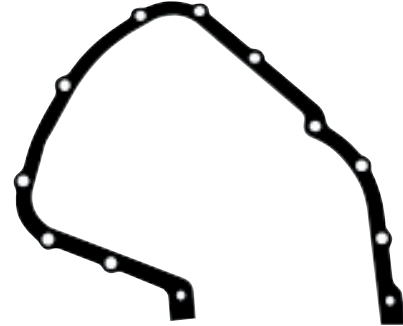

54168167

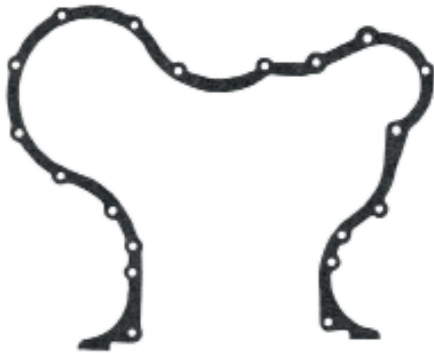

54135690



54135590



54167718



54154098



54154570

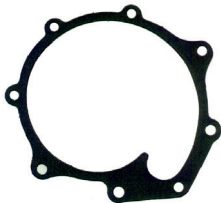

54166898



54135290



54153750



54134798



54134298



54134150



54103841

FORD CARGO FASE I / II 6 CILINDROS

Nº JOGO	DESCRIÇÃO
64111081	JOGO DE JUNTAS COMPLETO FASE I 6 CILINDROS SEM RETENTORES
74111081	JOGO DE JUNTAS SUPERIOR FASE I 6 CILINDROS COM RETENTORES
64131081	JOGO DE JUNTAS SUPERIOR FASE I 6 CILINDROS SEM RETENTORES
64131061	JOGO DE JUNTAS SUPERIOR FASE II 6 CILINDROS SEM RETENTORES
64111061	JOGO DE JUNTAS COMPLETO FASE II 6 CILINDROS SEM RETENTORES
74111061	JOGO DE JUNTAS COMPLETO FASE II 6 CILINDROS COM RETENTORES

Nº ABR	Nº ORIGINAL	DESCRIÇÃO	1	2	3	4	5	6
50005449		RETENTOR DIANTEIRO	1					
50051067	D3NN633A	GAXETA	2	2				2 2
54103841	CSNE6571A	RETENTOR DA HASTE VÁLVULAS	12	12	12	12	12	12
54134150		VEDAÇÃO DA INJEÇÃO	6	6	6	6	6	6
54134416	C5NE9448A	JUNTA DO COLETOR DO ESCAPAMENTO				2	2	2
54134973	60,5X82,5	JUNTA	1	1				1 1
54135454	C7NN6N008B	JUNTA DA TAMPA DO RETENTOR	1	1				1 1
54135590	C5NE6C051A	JUNTA DA TAMPA DO DISTRIBUIÇÃO	1	1				1 1
54152203	E7HN6051AA	JUNTA DO CABEÇOTE	1	1	1	1	1	1 1
54152390	E3HN9439AA	JUNTA DO COLETOR ADMISSÃO						1 1 1
54152450	E5HN6584AA	JUNTA DA TAMPA DE VÁLVULAS	1	1	1	1	1	1 1
54152550	E3HN6710AA	JUNTA DO CARTER	1	1				1 1
54153898	E5HN6020AB	JUNTA DA TAMPA DE DISTRIBUIÇÃO	1	1				
54154216	E5HN9448AB	JUNTA DO COL ETOR DO ESCAPAMENTO	2	2	2			
54154570	E5HN8507AA	JUNTA DO BLOCO DA BOMBA DE ÁGUA	1	1				1 1
54154683		JUNTA DA FLANGE DO COMBUSTÍVEL	1	1				1 1
54154952		JUNTA DO EXAUSTOR DA INJETORA	1	1				1 1
54155498		JUNTA DO CORPO DA BOMBA DE ÁGUA	1	1				1 1
54155596		JUNTA DO RETORNO DE ÓLEO	1	1	1	1	1	1 1
54155631	E5HN6N640AA	JUNTA DA BASE DA TURBINA	1	1	1	1	1	1 1
54155798		JUNTA DA ENTRADA DO ÓLEO	1	1	1	1	1	1 1
54159998	E5HN9439AA	JUNTA DO COLETOR DE ADMISSÃO	1	1	1			
54161398	E3HN6020AA	JUNTA DA TAMPA DE DISTRIBUIÇÃO						1 1
54161550	E5HN6N305C	JUNTA DA PLACA TRASEIRA	1	1				1 1
84168040		KIT DE BORRACHA E ARRUELA	1	1				1 1
84168026		KIT DE BORRACHA E ARRUELA DO JOGO SUPERIOR				1	1	
RE02448S		RETENTOR DIANTEIRO						1
RE02449S		RETENTOR TRASEIRO	1					1

• VENDE-SE AVULSO

APLICAÇÃO



FORD FTO 6 CIL.6.6L(FASE I)TURBO

FORD TRUCK C-1113/C-1114/C-1117/C-1313/C-1314/C-1317 1985/89 C-1215/C-1218/C-1415/C-1617 1985/91 C-1418/C-1615 1985/90 C-1517 1985/89 C-2217 1985/86

FORD FTO 6 CIL.7.8L(FASE II)TURBO

FORD TRUCK C-1419/C-1519 1990/92 C-1618 1988/91 C-1619 1988/90 C-1624 1990/90 C-2218 1988/90 C-2319 1990/90 C-2324 1990/91 C-3224 1989/91



FORD CARGO FASE I / II 6 CILINDROS



54152203



54152450



54159998



54152390

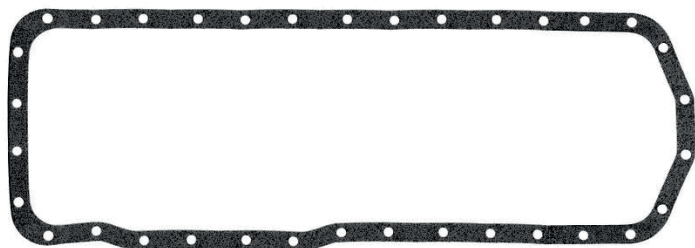

54152550



54135590



54161398



54153898



54154216



54134416

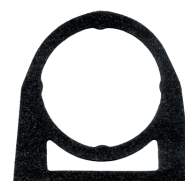

54135454



54154570



54161550

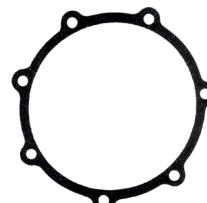

54154952

FORD CARGO FASE I / II 6 CILINDROS



54155798



54155596



54154683



54155631



54155498



54134973



RE02449S



RE02448S



5005449



54134150



5005167



54103841

84168040		KIT DE BORRACHAS	
Nº ABR	DESCRIÇÃO	QTD	
50007841	VEDADOR 27,0X3,3 MM	4	
50008941	VEDADOR 55,0X2,0 MM	1	
50900741	VEDADOR 44,8X2,0 MM	1	
50013824	ARRUELA DO BICO INJETOR	6	
50011041	VEDADOR 33,5X3,6 MM	1	
50010641	VEDADOR 24,0X3,8 MM	1	
50027341	VEDADOR 81,5X2,5 MM	1	
50010341	VEDADOR 23,0X3,5 MM	3	
50030041	VEDADOR 39,4X3,5 MM	3	
50050166	ARRUELA FB 20,0X24,0X1,5 MM	1	
54103841	VEDADOR HASTE VÁLVULA	12	
50009928	ARRUELA DE ALUMÍNIUOMINIO 6,2X10,2X1,0 MM	12	
50040041	VEDADOR 18,0X2,5 MM	6	
50005141	VEDADOR 7,65X1,78 MM	2	
50034641	VEDADOR 11,6X1,5 MM	8	

84168026		KIT DE BORRACHAS	
Nº ABR	DESCRIÇÃO	QTD	
50008941	VEDADOR 55,0X2,0 MM	1	
50013824	ARRUELA DO BICO INJETOR	6	
54103841	VEDADOR HASTE VÁLVULA	12	
50009928	ARRUELA DE ALUMÍNIO 6,2X10,2X1,0 MM	12	
50040041	VEDADOR 18,0X2,5 MM	6	
50034641	VEDADOR 11,6X1,5 MM	8	

FORD DOFA DURATORQ TRANSIT 2.4 TDCI 16 VALVULAS

Nº JOGO		DESCRIÇÃO		
64115132		JOGO DE JUNTAS COMPLETO DOFA DURATORQ TRANSIT 2.4 TDCI 16V DOHC 2009 SEM RETENTORES		1
74115132		JOGO DE JUNTAS COMPLETO DOFA DURATORQ TRANSIT 2.4 TDCI 16V DOHC 2009 COM RETENTORES		2
64135132		JOGO DE JUNTAS SUPERIOR DOFA DURATORQ TRANSIT 2.4 TDCI 16V DOHC 2009 SEM RETENTORES		3
74135132		JOGO DE JUNTAS SUPERIOR DOFA DURATORQ TRANSIT 2.4 TDCI 16V DOHC 2009 COM RETENTORES		4
Nº ABR	Nº ORIGINAL	DESCRIÇÃO		
54154602	5C1Q6051AA	JUNTA DO CABEÇOTE	1	1
54175640	257Q6260AA	JUNTA DA TAMPA DE VÁLVULA	1	1
54175440	X57Q8565AA	JUNTA DE ADMISSÃO	8	8
54175730	2C1Q9448AB	JUNTA DO ESCAPE	1	1
54175030		JUNTA DO TERMOSTATO	1	1
54175231		JUNTA DA BOMBA DE ÁGUA	1	1
54175830		JUNTA DA TAMPA TRASEIRA	1	1
54175130		JUNTA DO FILTRO DO ÓLEO	1	1
54176067		JUNTA DA ENTRADA DE ÓLEO DO TURBO	1	1
54175330		JUNTA DA BOMBA DE ÁGUA	1	1
84171630		JUNTA DO CARTER	1	1
84171740		KIT DE ARRUELAS E BORRACHAS	1	1
RE09084T		RETENTOR DA HÁSTE DE VÁLVULA	16	
RE09082T		RETENTOR TRASEIRO	1	
RE09083T		RETENTOR DIANTEIRO	1	

• VENDE-SE AVULSO

APLICAÇÃO



FORD TRANSIT TDCI 2009/12

FORD DOFA DURATORQ TRANSIT 2.4 TDCI 16 VALVULAS

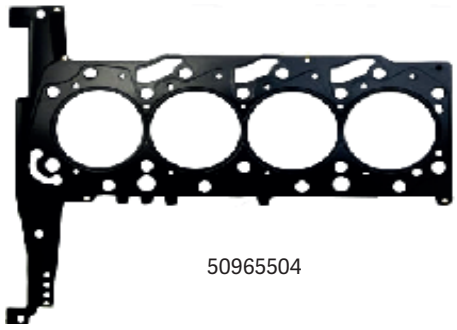

50965504

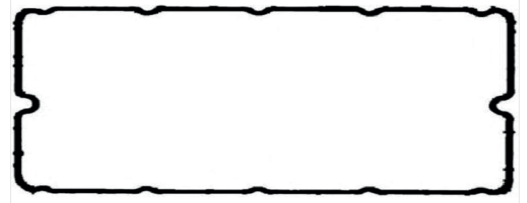

50918655



50965504

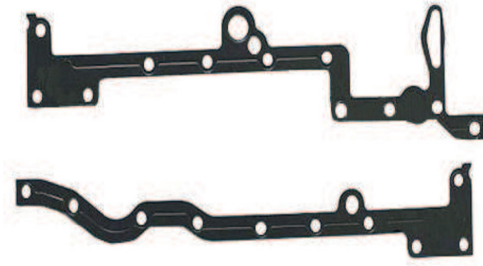

50918655



SSSSSSSS



50923990



SSSSSSSS



SSSSSSSS



50923990



SSSSSSSS

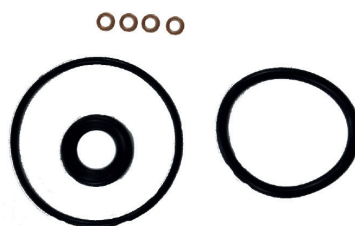

50923990

FORD RANGER DURATORQ TDCI OUMA 3.2 20 VÁLVULA DIESEL

Nº JOGO		DESCRIÇÃO		
64115142		JOGO DE JUNTAS COMPLETO RANGER DURATORQ 3.2 TDCI SEM RETENTORES		1
74115142		JOGO DE JUNTAS COMPLETO RANGER DURATORQ 3.2 TDCI COM RETENTORES		2
64135142		JOGO DE JUNTAS SUPERIOR RANGER DURATORQ 3.2 TDCI SEM RETENTORES		3
74135142		JOGO DE JUNTAS SUPERIOR RANGER DURATORQ 3.2 TDCI COM RETENTORES		4
Nº ABR	Nº ORIGINAL	DESCRIÇÃO		
54174702	7C166051CB	JUNTA DO CABEÇOTE	1	1
54174840	BK3Q6K260AA	JUNTA DA TAMP A DE VÁLVULA	1	1
84171530		JUNTA DO CARTER	1	1
54175440	X57Q856AA	JUNTA DO COLETOR DE ADMISSÃO	10	10
54174930	7C169448AB	JUNTA DO ESCAPAMENTO	1	1
54175231	YCH1Q6L50AD	JUNTA DA BOMBA DE ÁGUA	2	2
54175030		JUNTA DO TERMOSTATO	1	1
54175130		JUNTA DO FILTRO DE ÓLEO	1	1
54175330		JUNTA DA BOMBA DE ÁGUA	1	1
84171640		KIT DE BORRACHAS E ARRUELAS	1	1
RE09084T		RETENTOR DA HASTE DE VÁLVULA	20	
RE09082T		RETENTOE TRASEIRO	1	
RE09083T		RETENTOR DIANTEIRO	1	

• VENDE-SE AVULSO

APLICAÇÃO



FORD RANGER TDCI 2012/...

TROLLER T4 TGV 2013/...

FORD RANGER DURATORQ TDCI OUMA 3.2 20 VÁLVULA DIESEL

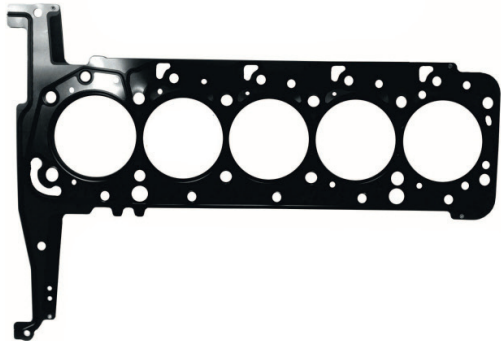

54174702

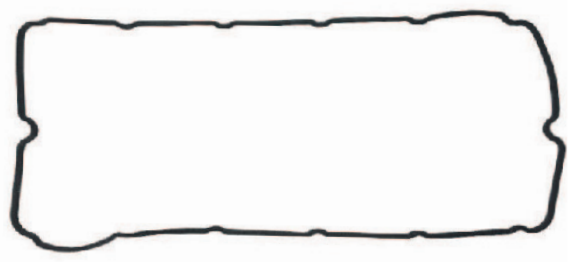

54174840



54174930



84171530



54175030



54175231



54175330



54175130



RE09083T



RE09082T



54175440



RE09084T

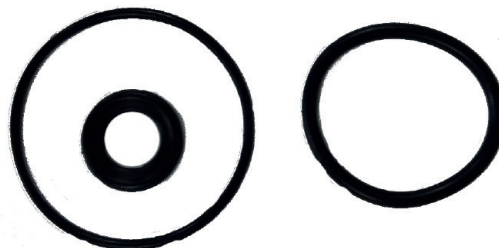

84171640

RANGER TRANSIT 2.2

Nº JOGO	DESCRIÇÃO	
74115282	JOGO DE JUNTAS COMPLETO TRANSIT 2.2 TDCI 16VÁLVULAS 2012/RANGER 2.2 2013 COM RETENTORES	1
74185282	JOGO DE JUNTAS COMPLETO TRANSIT 2.2 TDCI 16VÁLVULAS 2012/RANGER 2.2 2013 COM RETENTORES	2

Nº ABR	Nº ORIGINAL	DESCRIÇÃO		
54176702	BK3Q6051A1C	JUNTA DO CABEÇOTE		1
54176802	BK3Q6051C1C	JUNTA DO CABEÇOTE		1
54176140	BK2Q6K260AA	JUNTA DA TAMPA DE VALVULA	1	1
54175730	2C1Q9448AB	JUNTA DO ESCAPE	1	1
RE09083T	50X90X8,5/13,5	RETENTOR DIANTERIO	1	1
RE09117F	36X50X7	RETENTOR TRASEIRO	2	2
RE09084T	5,5X12X18,5	RETENTOR DA HASTE DE VÁLVULA	16	16
54175440	XS7Q8565AA	JUNTA DA ADMISSÃO	8	8
84171630	3S7Q6710AA	JUNTA DO CARTER	1	1
RE09082T		RETENTOR TRASEIRO		1
54175930	6C1Q9L461BB	JUNTA DA BASE DA TURBINA	1	1
54176067		JUNTA DA ENTRADA DE ÓLEO DO TURBO	1	1
54175231	YC1Q6L050AD	JUNTA DA DISTRIBUIÇÃO	1	1
84172040		KIT DE BORRACHAS	1	1

• VENDE-SE AVULSO

APLICAÇÃO



FORD TRUCK TRANSIT 2012/14 RANGER 2013/

RANGER TRANSIT 2.2

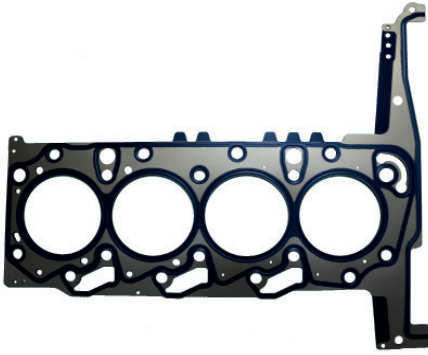

54176702

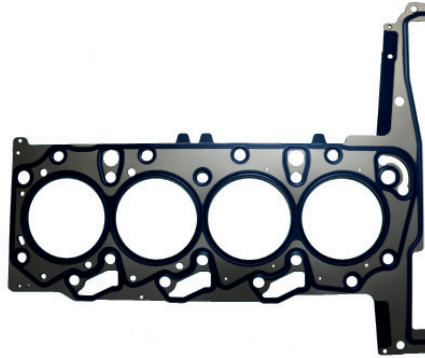

54176802

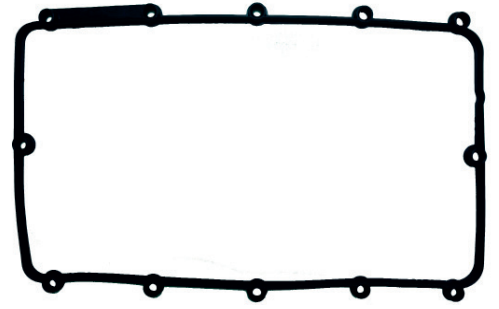

54176140

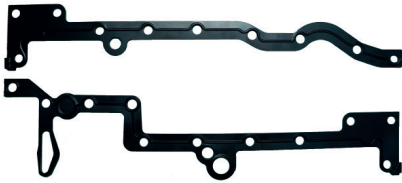

84171630



54175730



RE09083T



54175231



54176067



54175967



84172040



54175440



RE09117F



RE09082T



RE09084T



VALTRA

VALTRA

Nº ABR	MOTOR	DESCRIÇÃO	PÁGINA
64410121	420 DS	JOGO DE JUNTAS COMPLETO SEM RETENORES	278
64410141	420 DS	JOGO DE JUNTAS COMPLETO SEM RETENORES	278
64430121	420 DS	JOGO DE JUNTAS SUPERIOR SEM RETENORES	278
74410121	420 DS	JOGO DE JUNTAS COMPLETO COM RETENORES	278
74410141	420 DS	JOGO DE JUNTAS COMPLETO COM RETENORES	278
64410131	620 DS	JOGO DE JUNTAS COMPLETO SEM RETENORES	282
64410151	620 DS	JOGO DE JUNTAS COMPLETO SEM RETENORES	282
64430131	620 DS	JOGO DE JUNTAS SUPERIOR SEM RETENORES	282
64410161	620 DS	JOGO DE JUNTAS COMPLETO SEM RETENORES	282
64430161	620 DS	JOGO DE JUNTAS SUPERIOR SEM RETENORES	282
74410161	620 DS	JOGO DE JUNTAS SUPERIOR COM RETENORES	282

420 DS 4 CILINDROS ASPIRADO

Nº JOGO	DESCRIÇÃO	
64410121	JOGO DE JUNTAS COMPLETO 420 DS 4 CILINDROS ASPIRADO TRATOR 800/BL88 SEM RETENTORES	1
64410141	JOGO DE JUNTAS COMPLETO 420 DS 4 CILINDROS TURBO TRATOR 900/BM85/BM110/SEM RETENTORES	2
64430121	JOGO DE JUNTAS SUPERIOR 420 DS 4 CILINDROS ASPIRADO TURBO TRATOR 800/900/BM85/110 SEM RETENTORES	3
74410121	JOGO DE JUNTAS COMPLETO 420 DS 4 CILINDROS ASPIRADO TRATOR 800/BL88 COM RETENTORES	4
74410141	JOGO DE JUNTAS COMPLETO 420 DS 4 CILINDROS TURBO TRATOR 900/BM85/RETBM110 COM RETENTORES	5

Nº ABR	Nº ORIGINAL	DESCRIÇÃO			
54416018	23589880032	JUNTA DA TURBINA	1	1	1
54416367	835324277	JUNTA DA BOMBA HIDRÁULICA	1	1	1
54424136	836740277	JUNTA DA MESA DA TURBINA	1	1	1
54423147	836338985	JUNTA DO CARACOL DA TURBINA	1	1	1
54423067	836324580	JUNTA DA SAIDA DE ÓLEO	1	1	1
54420367	845008344	JUNTA DO RETORNO DO ÓLEO	1	1	1
54421967	836008449	JUNTA DO TUBO DE ÓLEO	1	1	1
54423667	836122282	JUNTA DA BOMBA DE ÓLEO	1	1	1
54421867	836008856	JUNTA DA VÁLVULA DE PRESSÃO	1	1	1
54420667	836647401	JUNTA DA BOMBA DE ALIMENTADORA	1	1	1
54424767	836659544	JUNTA DA BOMBA DE COMBUSTIVEL	1	1	1
54423967	836640335	JUNTA DA BOMBA DE ALIMENTADORA	1	1	1
84400826		KIT DE ARRUELAS	1	1	1
84400940		KIT DE BORRACHA	1	1	1
84401440		KIT SUPERIOR DE ARRUELAS E BORRACHA		1	
54424236	836316726	JUNTA DA MESA DA TURBINA	1	1	1
54422267	836647866	JUNTA DA BOMBA INJETORA	1	1	1
54421067	836747595	JUNTA DO COLETOR DE ADMISSÃO	1	1	1
54421150	836746362	JUNTA DA TAMPA DE VÁLVULAS	1	1	1
54420867	836107726	JUNTA DO CARTER	1	1	1
54422450	836107726	JUNTA DO CARTER	1	1	1
54483040	836647503	JUNTA DO VEDADOR DO ANEL DE CAMISA	12		12
54482800	836664155	JUNTA DO CABEÇOTE	1	1	1
54421267	836647419	JUNTA DA TAMPA DE DISTRIBUIÇÃO	1	1	1
54422067	83536796	JUNTA DA TAMPA DE DISTRIBUIÇÃO FRONTAL	1	1	1
54421667	836119349	JUNTA DA VÁLVULA TERMOSTÁTICA	1	1	1
54421367	836649343	JUNTA DA VÁLVULA TERMOSTÁTICA	1	1	1
54421567	836120128	JUNTA DA BOMBA DE ÁGUA	1	1	1
54421467	836120129	JUNTA DO RESFRIADOR DE ÓLEO	1	1	1
54422167	835336793	JUNTA DA TAMPA ROLAMENTO	1	1	1
54420567	836129946	JUNTA DA TMP DIANTEIRA	1	1	1
54421771	836014198	JUNTA DA BOMBA ÓLEO	1	1	1
RE00186F		RETENTOR TRASEIRO	1	1	
RE00185F		RETENTOR DIANTEIRO	1	1	

• VENDE-SE AVULSO

420 DS 4 CILINDROS ASPIRADO

APLICAÇÃO



VALTRA SISU 420D 4 CILINDROS 4.4LITROS ASPIRADO

VALTRA TRACTOR 800 2001/06 885S/985S 1994/09 BL88 2006/11

VALTRA SISU 420DS 4 CILINDROS 4.4LITROS TURBO

VALTRA TRACTOR 900 2001/06 A950 2008/17 BM85/100/110 2002/18 BM15i 2001/17

420 DS 4 CILINDROS ASPIRADO

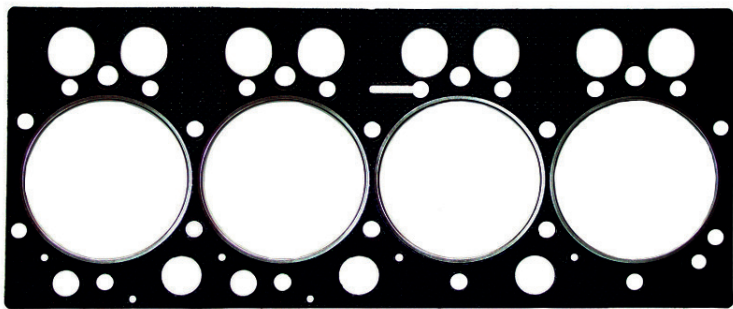

54482800

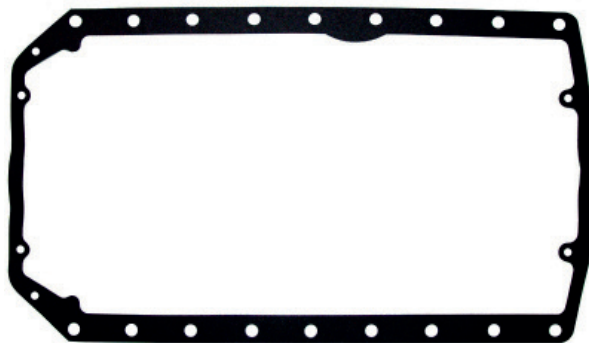

54420867



5442267

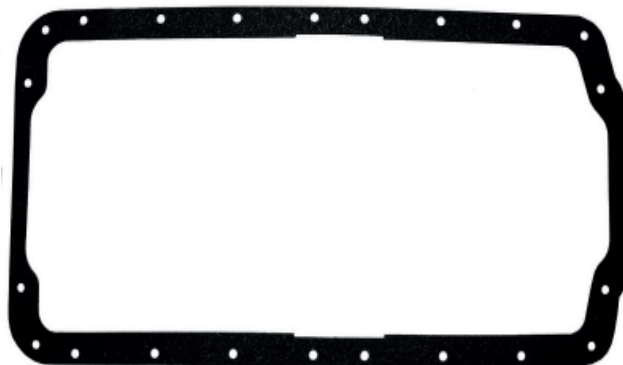

54422450



54421567



54421467

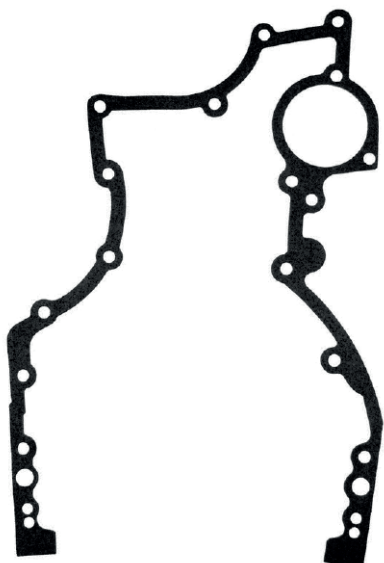

54421267



54421150



54421067

420 DS 4 CILINDROS ASPIRADO



54482800



54420867



54420367



54423067



54423667



54421867



54421667



54420667



54423967



54424767



54421771



54422167



54420367

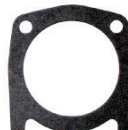

54416367



54422267



54424136



54424236



54416018

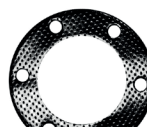

54423147



54483040



RE00185F



RE00186F



84400826

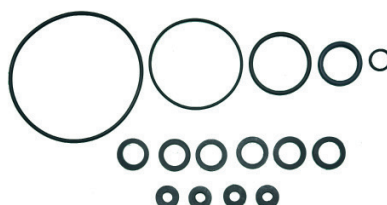

84400940

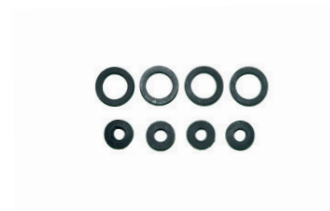

84401440

Nº JOGO	DESCRIÇÃO
64410131	JOGO DE JUNTAS COMPLETO 620 DS 6 CILINDROS SEM RETENTORES
64410151	JOGO DE JUNTAS COMPLETO 620 DS 6 CILINDROS SEM RETENTORES
74410151	JOGO DE JUNTAS COMPLETO 620 DS 6 CILINDROS COM RETENTORES
64430131	JOGO DE JUNTAS SUPERIOR 620 DS 6 CILINDROS SEM RETENTORES
64410161	JOGO DE JUNTAS COMPLETO 320 DS 3 CILINDROS SEM RETENTORES
64430161	JOGO DE JUNTAS SUPERIOR 320 DS 3 CILINDROS SEM RETENTORES
74410161	JOGO DE JUNTAS COMPLETO 320 DS 3 CILINDROS COM RETENTORES

Nº ABR	Nº ORIGINAL	DESCRIÇÃO	1	2	3	4	5	6	7
54416018	2358980032	JUNTA DA TURBINA	1	1	1				
54416367	835324277	JUNTA DA BOMBA HIDRAULICA				1	1	1	1
54420367	845008344	JUNTA DO RETORNO DE ÓLEO				1	1	1	
54420567	836129946	JUNTA DA TAMPA DIANTEIREIRA	1		1		1	1	1
54420667	836647401	JUNTA DA BOMBA ALIMENTADORA					1	1	1
54421267	836647419	JUNTA DA TAMPA DE DISTRIBUIÇÃO	1		1		1	1	1
54421367	836649393	JUNTA DA CARÇAÇA DE VÁLVULA DO TERMOSTATICA	1	1	1	1	1	1	1
54421467	836120129	JUNTA DO RESFRIADOR DE ÓLEO	1		1				
54421537	836120128	JUNTA DA BOMBA DE ÁGUA	1		1				
54421667	836119849	JUNTA DA VÁLVULA TERMOSTATO	1	1	1	1	1	1	1
54421771	836014198	JUNTA DA BOMBA DE ÓLEO	1		1		1	1	1
54421867	836008856	JUNTA DA VÁLVULA DE PRESSÃO					1	1	1
54421967	836008449	JUNTA DO TUBO DE ÓLEO	1		1		2	2	2
54422067	83536796	JUNTA DA TAMPA DE DISTRIBUIÇÃO FRONTAL	1		1		1	1	1
54422167	835336793	JUNTA DA TAMPA DO ROLAMENTO	1		1		1	1	1
54422267	836647866	JUNTA DA BOMBA INJETORA	1		1		1	1	1
54423567		JUNTA DO CARTER					2	2	2
54422567	836846304	JUNTA DA BOMBA DE ÁGUA					1	1	1
54422667	836846305	JUNTA DA BOMBA DE ÁGUA					1	1	1
54422867	836847496	JUNTA DO COLETOR DE ADMISSÃO	1	1	1	2	2	2	2
54422950	836646360	JUNTA DA TAMPA DE VÁLVULAS	1	1	1	2	2	2	2
54423067	836324580	JUNTA DA SAIDA DE ÓLEO				1	1	1	
54423147	836338985	JUNTA DO CARACOL DE TURBINA				1	1	1	
54423367	836847532	JUNTA DA SAIDA DE ADMISSÃO				1	1	1	1
54423467		JUNTA DA TAMPA TRASEIRA					1	1	1
54423567	836322183	JUNTA DO CARTER					1	1	1
54423667	836122282	JUNTA DA BOMBA DE ÓLEO					1	1	1
54423967	836640335	JUNTA DA BOMBA ALIMENTADORA	1		1		1	1	1
54424236	836316726	JUNTA DA MESA DA TURBINA				1	1	1	
54424767	836659544	JUNTA DA BOMBA DO COMBUSTIVEL					1	1	1
54424867	836855417	JUNTA DA TAMPA TRASEIRA DO CABEÇOTE	2	2	2	2	2	2	2
54424967		JUNTA LUBRIFICANTE DO CARTER	1		1		1	1	1
54425067	836855418	JUNTA DA PLACA DE CONEXÃO					1	1	1
54425550	836006704	JUNTA DO CARTER	1		1				
54482900	836647503	JUNTA DO CABEÇOTE	1	1	1	2	2	2	2
54483040		JUNTA DO VEDADOR DO ANEL DA CAMISA	9		9		18	18	18
84400440		KIT DE BORRACHA					1	1	1
84400520		KIT DE BORRACHA					1	1	1
84401140		KIT DE ARRUELA					1		
84401226		KIT DE ARRUELA					1		
84401340		KIT SUPERIOR DE ARRUELA				1			
84401540		KIT SUPERIOR DE ARRUELA E BORRACHA					1		
RE00186F		RETENTOR TRASEIRO	1					1	
RE00185F		RETENTOR DIANTEIRO	1					1	
RE09110F		RETENTOR DA HASTE DAS VÁLVULAS							24

● VENDE-SE AVULSO

APLICAÇÃO

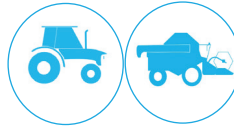

VALTRA SISU 320D ASPIRADO/320 DS 3 CIL.3.3L TURBO

VALTRA TRACTOR A650F/750F/850F/950F 2009/17 A650/750 2007/17 A850 2008/17 BF65 2005/13 BF75/77 2008/14 BL77 2006/11 700 1994/06

VALTRA SISU 620D 6 CIL.6.6L ASPIRADO

VALTRA TRACTOR 1180S 1996/08 1380S 1994/09 1680 1997/08 1880S 1996/09 BM120 2001/11

VALTRA SISU 620DS 6 CIL.6.6L TURBO

M.FERGUSON TRACTOR MF 6350 2003/10 MF 7390 2008/16 MF 7140/7150/7170/7180/7350/7370 2008/18

M.FERGUSON COLHEITADEIRA MF32 2009/16 MF 5650 1997/16

VALTRA TRACTOR BH145 900 2004/16 BH160 2001/10 BH165 2004/16 BH180 2003/17 BH180i 2003/14

BM185i 2001/17 BH205i 2008/16 BH210i 2007/16 BT150 2008/17 BT170/190 2010/17 BH140 2002/12

VALTRA COLHEITADEIRA BC4500 2007/15

VALTRA 620 DS G CILINDROS / 320 DS 3 CILINDROS

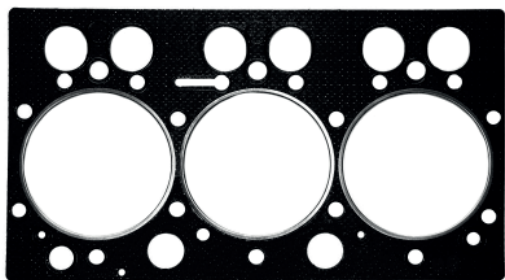

54482900

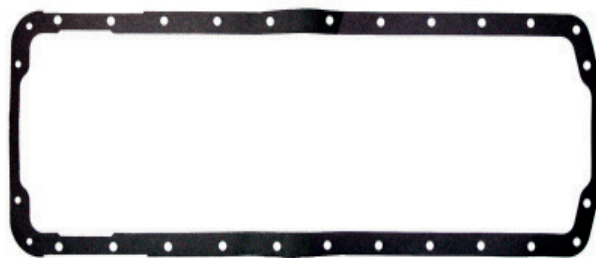

54423567



5442267

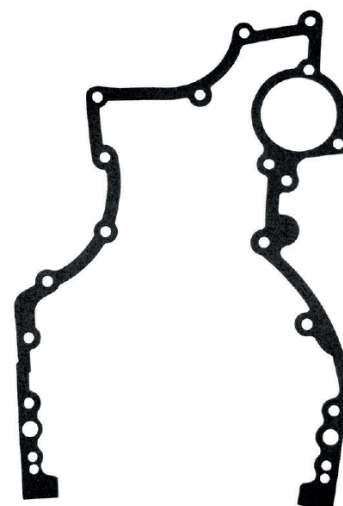

54421267

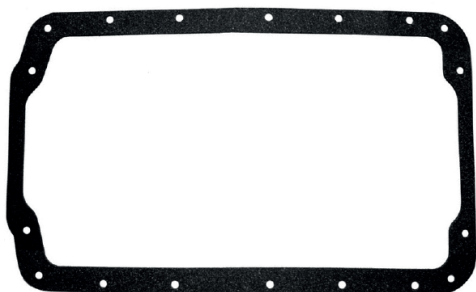

54425550



54422867



54422950



54422567



54422667



54421567

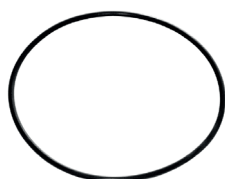

54483040



54421467



54424236

VALTRA 620 DS G CILINDROS / 320 DS 3 CILINDROS



84400440		KIT DE BORRACHAS	
Nº ABR	DESCRIÇÃO	QTD	
50037341	VEDADOR 15,0X2,5 MM	1	
54387340	VEDADOR 80,0X2,5 MM	1	
50096240	VEDADOR 10,0X21,0X8,0 MM	2	
50096340	VEDADOR 20,0X58,0X7,0 MM	3	

84401340		KIT DE BORRACHAS	
Nº ABR	DESCRIÇÃO	QTD	
50096240	VEDADOR 10,0 X 21,0 X 8,0 MM	2	
50096340	VEDADOR 20,0 X 28,6 X 7,0 MM	3	
50019723	ARRUELA COBRE 13,0 X 17,0 X 1,0 MM	6	
50021124	ARRUELA COBRE 14,0 X 18,0 X 1,5 MM	1	
50014120	ARRUELA COBRE 9,5 X 20,0 X 2,0 MM	3	
50069224	ARRUELA COBRE 18,0 X 22,0 X 1,5 MM	2	
50023624	ARRUELA COBRE 16,0 X 20,0 X 1,5 MM	2	
50092723	ARRUELA COBRE 12,0 X 16,0 X 1,0 MM	1	
50009923	ARRUELA COBRE 6,0 X 10,0 X 1,0 MM	7	

84400526		KIT DE BORRACHAS	
Nº ABR	DESCRIÇÃO	QTD	
50029720	ARRUELA COBRE 24,0 X 29,0 X 2,0 MM	1	
50019723	ARRUELA COBRE 13,0 X 17,0 X 1,0 MM	3	
50021124	ARRUELA COBRE 14,0 X 18,0 X 1,5 MM	1	
50014120	ARRUELA COBRE 9,5 X 20,0 X 2,0 MM	6	
50069224	ARRUELA COBRE 18,0 X 22,0 X 1,5 MM	10	
50015722	ARRUELA COBRE 10,0 X 13,8 X 0,8 MM	7	
50023624	ARRUELA COBRE 16,0 X 20,0 X 1,5 MM	3	
50009923	ARRUELA COBRE 6,0 X 10,0 X 1,0 MM	14	

84401226		KIT DE BORRACHAS	
Nº ABR	DESCRIÇÃO	QTD	
50019723	ARRUELA COBRE 13,0 X 17,0 X 1,0 MM	6	
50021124	ARRUELA COBRE 14,0 X 18,0 X 1,5 MM	15	
50014120	ARRUELA COBRE 9,5 X 20,0 X 2,0 MM	3	
50069224	ARRUELA COBRE 18,0 X 22,0 X 1,5 MM	6	
50015722	ARRUELA COBRE 10,0 X 13,8 X 0,8 MM	4	
50023624	ARRUELA COBRE 16,0 X 20,0 X 1,5 MM	2	
50092723	ARRUELA COBRE 12,0 X 16,0 X 1,0 MM	1	
50009923	ARRUELA COBRE 6,0 X 10,0 X 1,0 MM	7	

84401540		KIT DE BORRACHAS	
Nº ABR	DESCRIÇÃO	QTD	
50095640	VEDADOR 30,0 X 5,0 MM	2	
50096240	VEDADOR 10,0 X 21,0 X 8,0 MM	4	
50096340	VEDADOR 20,0 X 28,6 X 7,0 MM	6	
50021124	ARRUELA COBRE 14,0 X 18,0 X 1,5 MM	1	
50014120	ARRUELA COBRE 9,5 X 20,0 X 2,0 MM	6	
50069224	ARRUELA COBRE 18,0 X 22,0 X 1,5 MM	2	
50009923	ARRUELA COBRE 6,0 X 10,0 X 1,0 MM	14	

84400440		KIT DE BORRACHAS	
Nº ABR	DESCRIÇÃO	QTD	
50037341	VEDADOR 15,0 X 2,5 MM	1	
50095640	VEDADOR 30,0 X 5,0 MM	2	
50095740	VEDADOR 47,0 X 4,0 MM	1	
50087340	VEDADOR 80,0 X 2,5 MM	1	
50096240	VEDADOR 10,0 X 21,0 X 8,0 MM	4	
50096340	VEDADOR 20,0 X 28,6 X 7,0 MM	6	



CATÁLOGO DESENVOLVIDO POR : GUILHERME CORREIA DE FREITAS
PELA COMETA DESIGN



EMPRESA : ABR INDUSTRIA E COMERCIO DE AUTO PEÇAS EIRELI



RUA DAS CASTANHEIRAS 200 - GALPÃO 34 - JARDIM SÃO PAULO -

HORTOLÂNDIA TELEFONE : 19 3116-0145

E-MAIL : CONTATO@ABR.IND.BR

WWW.ABR.IND.BR

2023